

A Handbook on Electrical Engineering

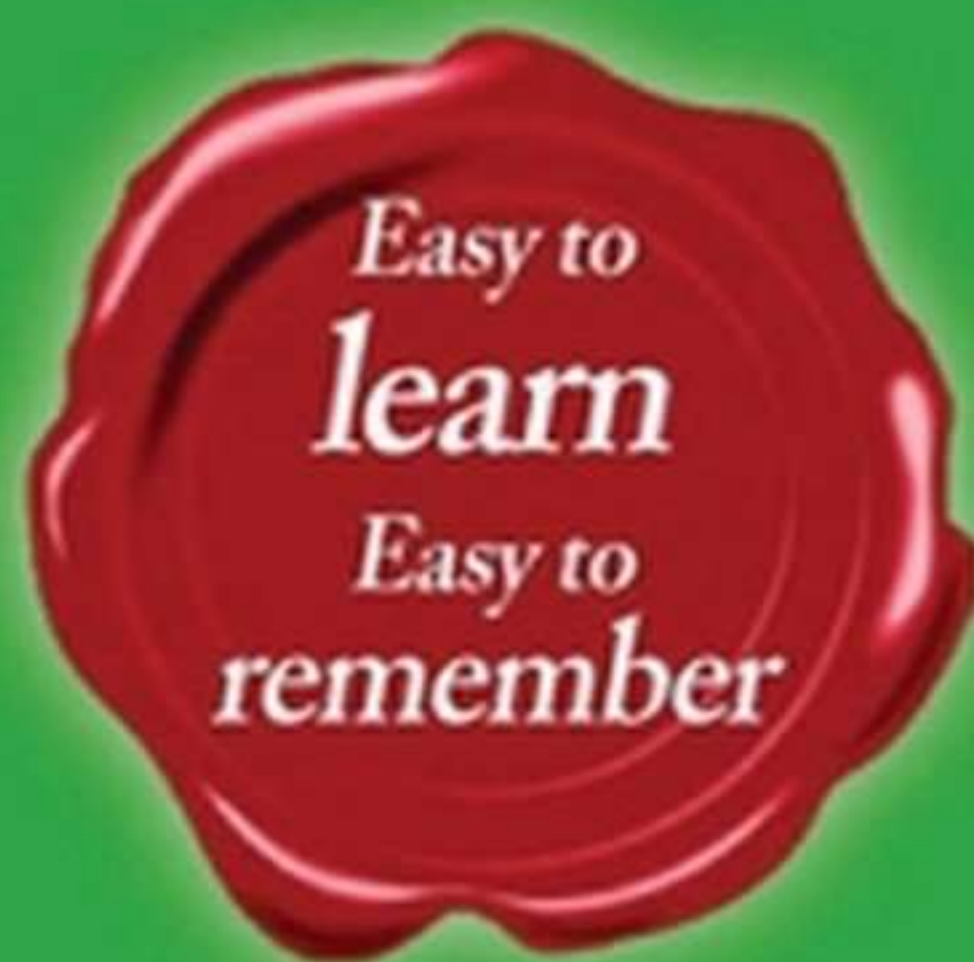

Contains well illustrated formulae & key theory concepts

IES, GATE, PSUs
& OTHER COMPETITIVE EXAMS





MADE EASY

India's Best Institute for IES, GATE & PSUs

Opens

Online Admission

for

Classroom Course

- Regular Classroom Course
- Weekend Classroom Course

Postal Course

Separately for
IES, GATE & PSUs

Test Series

Online Test Series
Classroom Test Series
Separately for IES, GATE & PSUs

Log on to: www.madeeasy.in

Courses

- ✓ Regular Classroom Course
- ✓ Weekend Classroom Course
- ✓ Postal Study Course
(Available only at MADE EASY office)
- ✓ Classroom & Postal Test Series
- ✓ Online Test Series
- ✓ Interview Guidance & PD

Streams

- ✓ Civil Engineering
- ✓ Electronics Engineering
- ✓ Electrical Engineering
- ✓ Mechanical Engineering
- ✓ Computer Science & IT
- ✓ Instrumentation Engineering

Course Content

- ✓ Classroom Teaching
 - ↳ GATE / IES / PSUs
 - ↳ Non-Tech: GS + English, Maths, RA
- ✓ Study Material
- ✓ GATE Test Series
- ✓ IES Test Series
- ✓ PD, GD & Interview Guidance

MADE EASY CENTRES

Delhi	44-A/1, Kalu Sarai, New Delhi - 110016; Ph: 011-45124612, 09958995830; Email: infodelhi@madeeasy.in
Noida	D-28, Sector - 63, Noida, Uttar Pradesh; Ph: 0120-6524612, 08860378009; Email: infonoida@madeeasy.in
Lucknow	BB1/67, Sector P, Aliganj, Lucknow; Ph: 09919111168, 08400029422; Email: infolucknow@madeeasy.in
Jaipur	AB-559, Kings Road, Nirman Nagar, Jaipur, Rajasthan; Ph: 0141-4024612, 09166811228; Email: infojaipur@madeeasy.in
Bhopal	Plot No. 46, ZONE - 2, M.P. Nagar, Bhopal; Ph: 0755-4004612, 08120035652; Email: infobhopal@madeeasy.in
Indore	Gemini Mall, PU3, A.B. Road, Vijay Nagar, Indore; Ph: 0731-4029612, 07566669612; Email: infoindore@madeeasy.in
Pune	2 nd Floor, Business Bay, P. of No. 84, Near R.T.O. Shivaji Nagar, Pune; Ph: 020-26058612, 09168884343; Email: infopune@madeeasy.in
Hyderabad	5-1-744, Bank Street, Koti Hyderabad; Ph: 040-24652374, 09160002324; Email: infohyderabad@madeeasy.in
Bhubaneswar	Plot No-1441, CRPF Square, Bhubaneswar, Odisha; Ph: 0674-6998888, 09040998888; Email: infobhubaneswar@madeeasy.in
Kolkata	755, Anandapur, Next to Fortis Hospital, Off-EM Bypass, Kolkata; Ph: 033-68888880, 08282888880; Email: infokolkata@madeeasy.in

A Handbook on

Electrical Engineering



Contains well illustrated formulae
& key theory concepts

For

IES, GATE, PSUs

& OTHER COMPETITIVE EXAMS



MADE EASY
Publications



MADE EASY Publications

Corporate Office: 44-A/4, Kalu Sarai (Near Hauz Khas Metro Station), New Delhi-110016
E-mail: info@madeeasy.in
Contact: 011-45124660, 8860378007
Visit us at: www.madeeasypublications.org

A Handbook on Electrical Engineering

Copyright © 2015, by MADE EASY Publications.

All rights are reserved. No part of this publication may be reproduced, stored in or introduced into a retrieval system, or transmitted in any form or by any means (electronic, mechanical, photo-copying, recording or otherwise), without the prior written permission of the above mentioned publisher of this book.

First Edition: 2012

Reprint : 2013

Reprint: 2014

Second Edition: Nov. 2014

Third Edition: 2015

Fourth Edition: 2015

Anoop

Preface

The objective of this book is to provide the crux of Electrical Engineering in a concise form to the students to brush up the formulae and important concepts required for IES, GATE, PSUs and other competitive examinations.

The Handbook contains all the formulae and important theoretical aspects of Electrical Engineering. It will provide much needed revision aid and study guidance before examinations. The specific presentation will help the readers to resurrect the concepts easily. The book covers the syllabus of UPSC Engineering Services exam, GATE and other competitive exams.

Special "Notes" are given in order to emphasize the specific content and helpful to resurrect in short span. Some quick tricks have also been introduced to save time.

Any error in printing/calculations/concepts pointed out by the reader will be acknowledged with thanks by MADE EASY.



B. Singh (Ex. IES)

B. Singh

CMD, MADE EASY Group

© All rights reserved by MADE EASY PUBLICATIONS. No part of this book may be reproduced or utilized in any form without the written permission from the publisher.

CONTENTS

Unit-I: Power Systems.....	7-74
Unit-II: Electrical Machines	75-137
Unit-III: Power Electronics	138-218
Unit-IV: Measurement & Instrumentation	219-288
Unit-V: Network Theory	289-333
Unit-VI: Control Systems	334-385
Unit-VII: Signals & Systems	386-417
Unit-VIII: Analog Electronics	418-489
Unit-IX: Digital Electronics	490-549
Unit-X: Electrical Materials	550-586
Unit-XI: Electromagnetic Theory	587-630
Unit-XII: Microprocessors	631-665
Unit-XIII: Communication Systems	666-692

○○○○

A Handbook on Electrical Engineering

1

Power Systems

CONTENTS

1. Supply System	8
2. Line Parameters	12
3. Performance of Transmission Line	26
4. Concept of Corona	36
5. Mechanical Design of Overhead Lines	40
6. Balanced and Unbalanced Faults	43
7. Power System Stability	49
8. Power System Transients	53
9. Economic Load Dispatch	56
10. Underground cable	59
11. Protective Relays	65
12. Circuit Breakers	69
13. Generating Power Stations	71
14. Loads and Load Curves	73

- The problems encountered with high voltages are the insulation of the equipment, corona, radio and television interference.
- The voltage level of a system is therefore governed by the amount of power to be transmitted and the length of the line.

Basic Structure of Power System

Electrical energy generated at generating stations by synchronous generator. The generating voltages are generally 11 kV and 33 kV. This voltage is then stepped up by step up transformer upto 132 kV, 220 kV, 400 kV for transmission over long distances. Again this high voltages are brought down to subtransmission level i.e. 66 kV to supply large consumer and further stepped down for primary distribution i.e. 33 kV, 11 kV. For secondary distribution level voltage is brought down to 400 V for 3 ϕ and 230 V for 1 ϕ for residential and commercial used.

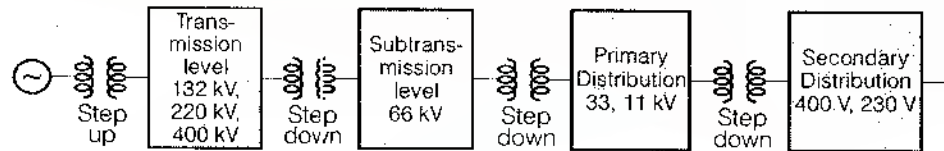

Note:

- Generating stations are interconnected by the lines.
- Transmission lines, when interconnected with each other, becomes transmission networks.
- The combined transmission and distribution network is known as the "power grid".

Effect of System Voltage on Transmission of Power

- Power loss in the line is inversely proportional to the system voltage and power factor both.
- Percentage voltage drop in resistance decreases with the increase in the system voltage.
- Weight of the conductor material for the line will decrease with the increase in supply voltage and power factor.
- Efficiency of transmission, increases with the increase of supply voltage and power factor.
- Higher supply voltages also enhance the system stability.

Voltage Level

(a) Low voltage — $\begin{cases} 230 \text{ V (1}\phi\text{)} \\ 400 \text{ V (3}\phi\text{)} \end{cases}$

(b) High voltage — $\begin{cases} 11 \text{ kV} \\ 33 \text{ kV} \end{cases}$

(c) Extra high voltage: 66 kV, 132 kV, 220 kV.

(d) Modern EHV: 400 kV

(e) Ultra high voltage: 765 kV and above.

Conductor Used for Transmission Line

- Copper conductor
- ACSR (Aluminium conductor steel reinforced).
- ACAR (Aluminium conductor alloy reinforced).
- AAAR (All Aluminium alloy reinforced).
- Expanded ACSR conductor: Normally used for EHV lines.

Types of Conductor

- Solid conductor: It has high skin effect.
- Hollow conductor: Preferred under heavy current i.e. more than 1000 Amp.
- Stranded conductor.
- Composite standard conductor: used for voltage ≤ 220 kV.
- Bundle conductor: Used for voltage > 275 kV.

Advantage of Bundle Conductor

- Self distance (GMR) increased without change in mutual distance.
- Voltage gradient reduced so corona loss reduce.
- It reduces the interference with near by communication line.

- Inductance (L) of transmission line reduces and capacitance (C) increases.
- Surge impedance i.e. $Z_s = \sqrt{\frac{L}{C}}$ decreases.
- Power system stability increases.

Insulators

Over head line insulators provide the required insulation to the line conductors from each other and from the supporting structures electrically. Most commonly used materials are porcelain and toughened glass.

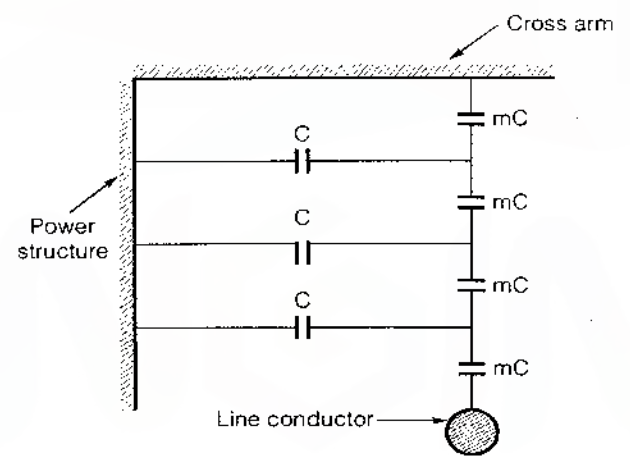

where, C : Capacitance between metal part of the insulator and tower structure
 mC : Capacitance of each insulator disc.

$$mC > C$$

Note:
 The stress experienced by the disc near the power conductor is more than the stress experience by the disc near the cross-arm.

String Efficiency

$$\text{String efficiency} = \frac{\text{Voltage across the whole string}}{n \times (\text{Voltage across the unit adjacent to line conductor})}$$

where, n = Number of insulator discs in the string

Note:
 As the number of disc increases string efficiency decreases.

Methods of Equilising Potential Across Each Disc

- Increase the length of cross arm.
- Capacitance grading or grading of units.
- Use of grading rings or static shielding.

Types of Insulator

- (a) Pin type insulator: Pin type insulator operate satisfactory upto 25 kV.
- (b) Multipine type insulator: Operates upto 33 kV
- (c) Suspension type insulator: A suspension insulator is designed to operate at 11 kV.
- (d) Strain type insulator: Strain type insulator mechanically strong. It is used when direction of transmission line changes across river crossing and at the dead end of the transmission line.
- (e) Shackle type: Shackle type insulator are used in low tension cable. These insulator can be operated either horizontally or vertically.



Line Parameters

2

Transmission line is a carrier on which bulk amount of power from a remote generating station to the operative areas is being carried out.

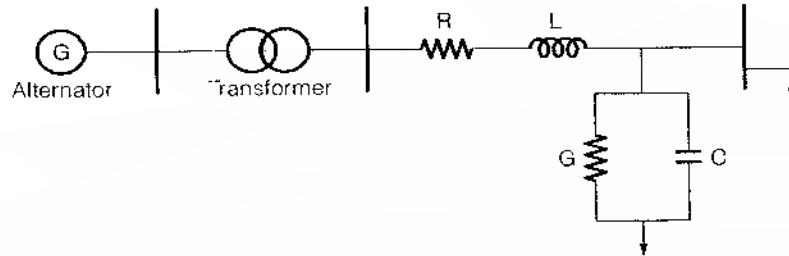

Transmission line is

- (i) series combination of resistance (R) and inductance (L) and
- (ii) Parallel combination of shunt conductance (G) and capacitance (C).

Note:

- The line parameter of transmission line is calculated in per unity or per km and are constant for entire line length.
- The shunt conductance is caused by leakage current.
- In transmission line if G = 0 means leakage current is assume to be zero.
- Power loss in the conductor is only due to series resistance.
- Power transmission capacity of the line is mainly governed by the series inductance.

□ Resistance of a conductor

$$R_{\text{eff}} = \frac{\text{Power loss in conductor}}{I^2} \text{ ohms.}$$

where, R_{ef} = Effective resistance of the conductor

□ D.C. Resistance of a Conductor

$$R_{\text{dc}} = \rho \frac{l}{A} \text{ ohms.}$$

- where,
- ρ = Resistivity of conductor, $\Omega\text{-m}$
 - l = Length of conductor, metre
 - A = Cross-sectional area, m^2

Note:

The effective resistance is equal to the dc resistance of the conductor only if the current is uniformly distributed through out the cross-sectional area of the conductor (i.e. for DC only).

Skin Effect

If DC is passed in a conductor, the current density is uniform over the cross-section of the conductor but when an alternating current flows through a conductor, the distribution tends to become non uniform. There is a tendency of the current to crowd near the surface of the conductor. This phenomenon is called "skin effect".

Remember:

Skin effect increases with increase in frequency, conductor diameter and permeability.

Proximity Effect

When two or more conductors are in proximity, their electromagnetic field interact with each other, with the result that the current in each of them is redistributed such that the greater current density is concentrated in that part of the strand most remote from the interfering conductor. In each case, a reduced current rating results from the apparent increase of resistance.

Magnetic Flux Density

Biot-savart's law

- Magnetic flux at any point produced by a current carrying element

$$dB = \frac{\mu}{4\pi} \frac{Idl \times (\vec{r})}{r^3}$$

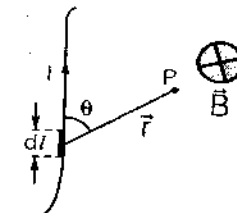

where, dB = Infinitesimal flux density at point P
 I = Current in element
 dl = Length of element
 θ = Angle between current direction and radius vector to P
 r = Radius vector
 μ = Permeability of medium

□ Magnetic flux density B at any point to an infinite conductor.

$$B = \frac{\mu I}{2\pi R}$$

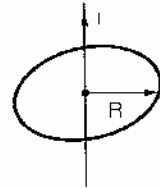

where, R = Radial distance of the point from the conductor.

Note:

The direction of the flux density is normal to the plane containing the conductor and radius vector R .

Ampere's law

$$\int H \cdot dl = I_{\text{enclosed}}$$

where, H = Magnetic field intensity
 I = R.M.S. value of current enclosed by an amperian loop.

Relation Between Magnetic Flux Density and Magnetic Field Intensity

$$B = \mu H, \quad \mu = \mu_0 \mu_r$$

where, $\mu_0 = 4\pi \times 10^{-7}$ H/m
 = Permeability of free space and
 μ_r = Relative permeability of the medium
 $\mu_r = 1$ (for non magnetic material)

Inductance

Inductance of an inductor is the ratio of its total magnetic flux linkages to the current I through the inductor.

$$L = \frac{N\psi_m}{I} = \frac{\lambda}{I} \text{ Henry}$$

where, Ψ_m = Magnetic flux linkages through a single turn
 N = Total number of turns.
 λ = Total magnetic flux linkages

Above formulae is valid for a medium in which the permeability is constant.

Remember:

The permeability of ferrous medium is not constant. For such cases the inductance is defined as the ratio of infinitesimal change in flux linkage to the infinitesimal change in current producing it

$$L = \frac{d\lambda}{dI} \text{ Henry}$$

□ Flux linkages within the conductor

$$\Psi_{\text{int}} = \frac{\mu I}{8\pi} \text{ Wb-T/m}$$

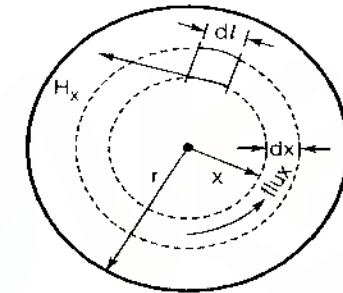

where, Ψ_{int} = Total internal flux linkages
 I = R.M.S. value of the current.

$$\Psi_{\text{int}} = 0.5I \times 10^{-7} \text{ Wb-T/m}$$

□ Inductance of the conductor, contributed by flux within the conductor:

$$L_{\text{int}} = 0.5 \times 10^{-7} \text{ H/m} \quad \text{as} \quad L_{\text{int}} = \frac{\Psi_{\text{int}}}{I}$$

- Flux linkages outside the conductor

$$\Psi_{12} = \frac{\mu I}{2\pi} \ln\left(\frac{D_2}{D_1}\right) \text{ Wb-T/m}$$

for $\mu_r = 1$

$$\Psi_{12} = 2 \times 10^{-7} I \ln\left(\frac{D_2}{D_1}\right) \text{ Wb-T/m}$$

where Ψ_{12} = Total flux linkages between points 1 and 2

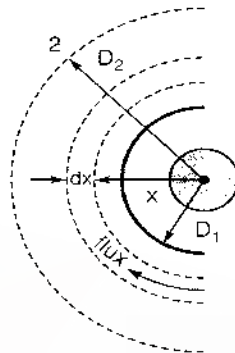

- Inductance of the conductor, contributed by flux between points 1 and 2:

$$L_{12} = 2 \times 10^{-7} I \ln\left(\frac{D_2}{D_1}\right) \text{ H/m}$$

- Inductance of a single phase two wire line:

$$L = 4 \times 10^{-7} I \ln\left(\frac{D}{r'}\right) \text{ H/m}$$

where, D = Distance between two solid conductors of same radii r
 r' = Radius of fictitious conductor = $0.7788 r$

- Flux linkages of one conductor in an array:

Figure shows an array of n long round conductors suspended parallel to each other in space and carrying currents I_1, I_2, \dots, I_n .

Such that: $I_1 + I_2 + I_3 + \dots + I_n = 0$

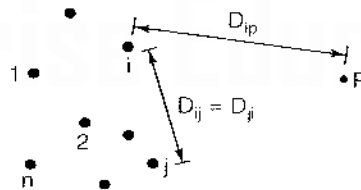

$$\Psi_i = 2 \times 10^{-7} \left[I_1 / n \frac{1}{D_{i1}} + I_2 / n \frac{1}{D_{i2}} + \dots + I_i / n \frac{1}{D_{ii}} + \dots + I_n / n \frac{1}{D_{in}} \right] \text{ Wb-T/m}$$

where, Ψ_i = Total flux linkages of conductor i

D_{ij} = Centre to centre distance between conductor i and j

D_{ii} = Distance of conductor i from itself and equals $0.7788 r_i$

Inductance of Composite Conductor Lines

Conductor M consists of m similar parallel sub-conductors and conductor N consists of n similar parallel sub-conductors.

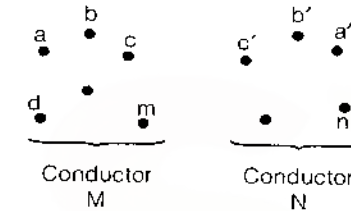

(Single phase line having composite conductors)

If line current is I , then each strand of conductor M carries a current I/m and each strand of conductor N carries a current of $-I/n$ (the conductor N being the return conductor).

$$L_M = 2 \times 10^{-7} \times I \ln \left[\frac{(D_{aa} D_{ab} \dots D_{am}) (D_{ba} D_{bb} \dots D_{bn}) \dots (D_{ma} D_{mb} \dots D_{mn})}{(D_{aa} D_{ab} \dots D_{am}) (D_{ba} D_{bb} \dots D_{bn}) \dots (D_{ma} D_{mb} \dots D_{mn})} \right]^{1/mn} \text{ H/m}$$

where, L_M = inductance of conductor M

$$L = 2 \times 10^{-7} I \ln \left(\frac{\text{GMD}}{\text{GMR}} \right)$$

Remember:

- GMD = mn^{th} root of the product of mn distances (known as the geometric mean distance between conductor M and conductor N and denoted by D_m).
- GMR = $(m^2)^{\text{th}}$ root of the product of m^2 distances these being the distances from each sub-conductor of conductor M to every other sub-conductor of conductor M (including $D_{aa}, D_{bb}, \dots, D_{mm}$).
- GMR = Geometric mean radius (denoted by D_g).
- $D_{aa} = 0.7788$ times the radius of sub-conductor 'a'.

Inductance of 3-φ Line With Equivalent Spacing.

Assuming balanced currents i.e. ($I_a + I_b + I_c = 0$)

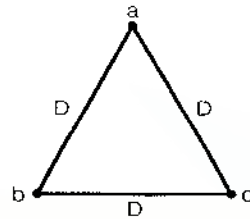

$$L_a = 2 \times 10^{-7} \ln \left(\frac{D}{r'} \right) \text{ H/m}$$

- where, L_a = Inductance of phase a
- D = Distance between any two phases
- $r' = 0.7788r$ = Radius of fictitious conductor
- = 0.7788 times the radius of conductor
- $L_a = L_b = L_c$ (Because of symmetry)

Inductance of 3-φ line with unsymmetrical spacing

In this case the lines are transposed.

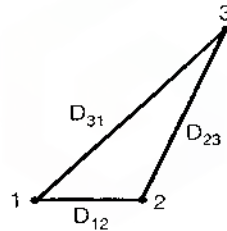

Transposition of transmission line

When ever 3φ unsymmetrical line running parallel and neighbour to the communication line it cause interference in the communication line. In order to eliminate the communication interference transposition of line is recommended.

Change the position of power conductor at regular interval with equidistance for a given line length, so that the position of power conductor is replaced by its successive phase conductor.

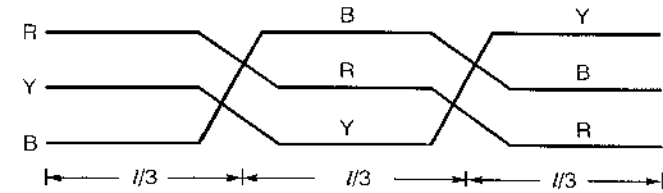

Advantages of Transposition

- (i) Net resultant flux ϕ_r which link with communication line become zero.
- (ii) GMD/phase equal.
- (iii) L/phase equal.
- (iv) I/phase equal.
- (v) Flux per phase equal.

Note:

Transposition of transmission line is an old technique. The radio interference is eliminated by completely insulating any one of the phases.

Inductance of Phase-1

$$L_1 = 2 \times 10^{-7} \ln \left(\frac{D_{eq}}{r'} \right) \text{ H/m}$$

where, L_1 = inductance of phase 1

$$D_{eq} = \sqrt[3]{D_{12}D_{23}D_{31}}$$

= Equivalent spacing

= Geometric mean of the distance of the line.

Inductance of Bundled Conductor Lines

(a) For a two conductor (duplex) arrangement

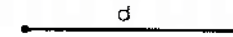

$$D_s^b = \sqrt[4]{(D_s \cdot d)^2} = \sqrt{D_s \cdot d}$$

(b) For a three conductor (triplex) arrangement

$$D_s^b = \sqrt[3]{(D_s \cdot d \cdot d)^3} = \sqrt[3]{D_s \cdot d^2}$$

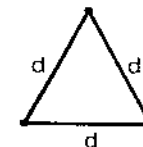

(b) For a four-conductor (quadruplex) arrangement

$$D_s^b = \sqrt[6]{(D_s \cdot d \cdot d \cdot d \sqrt{2})^4}$$

$$= 1.09 \times \sqrt[4]{D_s \cdot d^3}$$

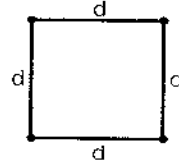

where, D_s^b = Geometric mean radius of bundled conductor

D_s = Geometric mean radius of each sub-conductor of bundle

d = Spacing between the sub-conductors of a bundle

Remember:

- GMD of a bundled conductor line can be found by taking the root of the product of distances from each conductor of a bundle to every other conductor of other bundles.
- Inductance of bundled conductor line is less than the inductance of the line with one conductor per phase.

Inductance of Double Circuit 3-φ Line

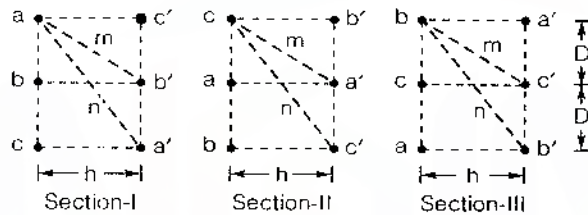

Inductance per phase per metre length

$$L = 2 \times 10^{-7} \ln \left[2^{1/6} \left(\frac{D}{r'} \right)^{1/6} \cdot \left(\frac{m}{n} \right)^{1/3} \right] \text{ H/phase/m.}$$

Mutual Inductance

Mutual inductance is defined as the flux linkages of one circuit due to the current in the second circuit per-ampere of current in the second circuit. If the current I_2 produces λ_{12} flux linkages with circuit 1. The mutual inductance is

$$M_{12} = \frac{\lambda_{12}}{I_2} \text{ Henry}$$

Electrical Field and Potential Difference

- The lines of electric flux originate on the positive charges on one conductor and terminate on the negative charges on the other conductor.
- If a long straight cylindrical conductor has a uniform charge throughout its length and is isolated from other charges.

□ Electric field intensity E at any point

$$E = \frac{q}{2\pi \epsilon x} \text{ V/m}$$

where, q = Charge on conductor per unit length

ϵ = Permittivity of the medium

x = Distance from conductor to the point under consideration.

□ The potential difference between two points

$$V_{xy} = \frac{q}{2\pi \epsilon} \ln \left(\frac{D_y}{D_x} \right) \text{ Volts.}$$

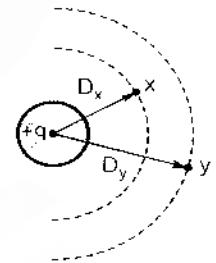

where, D_x, D_y = Distance of point x and y from charge q
 q = Charge per unit length

□ The potential difference between two conductor of an array of parallel conductors

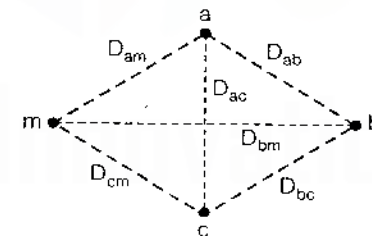

(An array of m charged conductors)

$$V_{ac} = \frac{1}{2\pi \epsilon} \left[q_a \ln \frac{D_{ab}}{r_a} + q_b \ln \frac{r_b}{D_{ba}} + q_c \ln \frac{D_{cb}}{D_{ca}} + \dots + q_m \ln \frac{D_{mb}}{D_{ma}} \right]$$

Capacitance

Capacitance of Two Wire Line

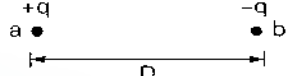
$$C_{ab} = \frac{0.01206}{\log\left(\frac{D}{r}\right)} \mu\text{F/km}$$

where, C_{ab} = Capacitance between the conductors per unit length
 q = Charge per unit length
 r = Radius of conductor a and b

If the conductor have different radii

$$C_{ab} = \frac{0.01206}{\log\left(\frac{D}{\sqrt{r_a r_b}}\right)} \mu\text{F/km}$$

where, r_a, r_b = Radius of conductor 'a' and conductor 'b' respectively.
 C_{ab} = Line to line capacitance

Line to neutral capacitance

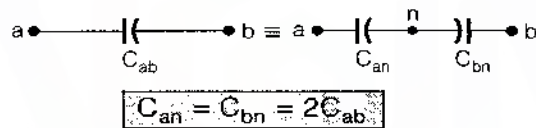

Charging Current

- The current caused by the alternate charging and discharging of the line due to alternating voltage is called **charging current** of the line.

Note:

Charging current flows in a line even when the line is open circuited and affects the voltage drop, efficiency and power factor of the line.

Charging Current for 1-φ line

$$I_C = j\omega C_{ab} V_{ab} = j 2\pi f C_{ab} V_{ab}$$

where, V_{ab} = Potential difference between conductor a and b
 f = Frequency of alternating voltage

Capacitance of 3-φ line with equilateral spacing

$$C_n = \frac{0.02412}{\log\left(\frac{D}{r}\right)} \mu\text{F/km}$$

where, C_n = Line to neutral capacitance
 D = Spacing between conductors
 r = Radius of each conductor

Charging current per phase

$$I_C = j\omega C_n V_{an}$$

Capacitance of 3-φ line with asymmetrical spacing

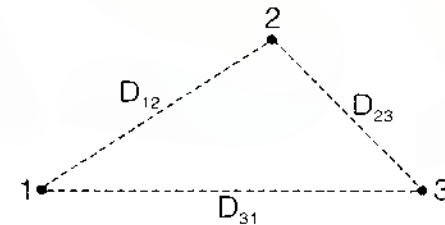

$$C_n = \frac{0.02412}{\log\left(\frac{D_{eq}}{r}\right)} \mu\text{F/km}$$

where,

$$D_{eq} = \sqrt[3]{D_{12} D_{23} D_{31}}$$

Capacitance of bundled conductor lines

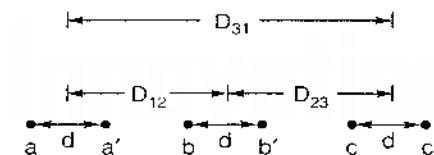

$$C_n = \frac{0.02412}{\log\left(\frac{D_{eq}}{\sqrt{rd}}\right)} \mu\text{F/km}$$

The term \sqrt{rd} is known as GMR or self GMD for a two bundle; denoted by D_{sc}^b

(a) For a two conductor bundle

$$D_{sc}^b = \sqrt{rd}$$

(b) For a three conductor bundle

$$D_{sc}^b = \sqrt[3]{(r \times d \times d)^3} = \sqrt[3]{rd^2}$$

(c) For a four conductor bundle

$$D_{sc}^b = \sqrt[4]{(r \times d \times d \times \sqrt{2}d)^4} = 1.09\sqrt[4]{rd^3}$$

Effect of Ground on Line Capacitance (Method of Images)

The presence of ground alters the electric field of a line and hence affect the line capacitance.

(a) For 1-φ line

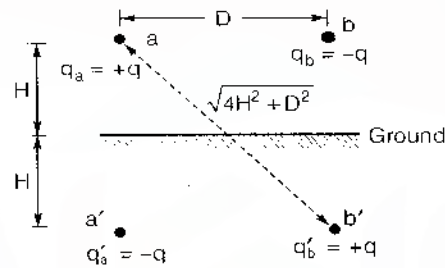

$$C_{ab} = \frac{0.01206}{\log \left(\frac{D}{r \left(1 + \frac{D^2}{4H^2} \right)^{0.5}} \right)} \mu F/km$$

where, H = Height of conductor from ground

$$C_{an} = 2C_{ab} = \frac{0.02412}{\log \left(\frac{D}{r'} \right)} \mu F/km$$

$$r' = r \sqrt{1 + \left(\frac{D}{2H} \right)^2}$$

(b) For 3-φ line

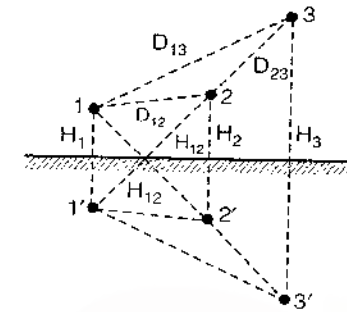

Conductors of a 3-phase line with image charges

$$C_n = \frac{0.02412}{\log \left(\frac{D_{eq}}{r} \right) - \log \left[\frac{\sqrt[3]{H_{12}H_{23}H_{31}}}{\sqrt[3]{H_1H_2H_3}} \right]}$$

where,

$H_1, H_2, H_3,$ and H_{12}, H_{23}, H_{31} are shown in figure. C_n is in $\mu F/km$.

Remember:

Presence of ground increases the line capacitance by small amount.



Performance of Transmission Line

3

Type of Transmission line	Classification based on $f \cdot l$	Classification based on length if line is power line i.e. $f = 50$ Hz	Based on operating voltage	Effect of capacitance
Short line	$fl < 4000$ Hz km	$l < 80$ km	0-20 kV	Neglected
Medium line	$4000 < fl < 12000$ Hz km	$80 \text{ km} < l < 240$ km	20-100 kV	Capacitor is lumped and constant
Long line	$fl = 12000$ Hz km	$l > 240$ km	> 100 kV	Capacitance is uniformly distributed

where, f = Operating frequency
 l = Length of transmission line

Short transmission lines

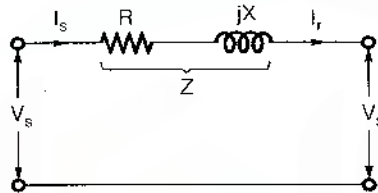

where, V_s = Sending end voltage
 V_r = Receiving end voltage
 I_s = Sending end current
 I_r = Receiving end current

$$I_s = I_r, \quad V_s = V_r + I_r Z$$

In Matrix form:

$$\begin{bmatrix} V_s \\ I_s \end{bmatrix} = \begin{bmatrix} A & B \\ C & D \end{bmatrix} \begin{bmatrix} V_r \\ I_r \end{bmatrix}$$

$$\begin{bmatrix} V_s \\ I_s \end{bmatrix} = \begin{bmatrix} 1 & Z \\ 0 & 1 \end{bmatrix} \begin{bmatrix} V_r \\ I_r \end{bmatrix}$$

So, $A = 1, B = Z, C = 0, D = 1$

$$V_s = V_r + I_r R \cos \phi_r + j I_r X \sin \phi_r$$

- Note:**
- The performance of transmission line is determine by efficiency and voltage regulation.
 - For rotating machine speed regulation determine and for static machine voltage regulation determine.
 - For satisfactory performance lower the regulation and higher the efficiency.

Voltage Regulation

It is the change in receiving end voltage from no load to full load while keeping the sending end voltage constant and made supply frequency constant.

$$\text{Voltage regulation} = \frac{V_r' - V_r}{V_r}$$

where, V_r' = Receiving end voltage under no load condition
 V_r = Receiving end voltage under full load condition

Regulation of Short Transmission Line

$$\text{Regulation} = \frac{I_r R \cos \phi_r \pm I_r X \sin \phi_r}{V_r}$$

where, $+$ → For lagging power factor
 $-$ → For leading power factor

- Note:**
- Regulation is always positive for lagging power factor.
 - Regulation may be positive, negative or zero for leading power factor.
 - In short line sending end power factor always less than receiving end power factor.
 - Short line is always symmetrical and reciprocal.
 - Regulation maximum when $\phi_r = \theta$.

Maximum voltage regulation occurs when

$$\phi_r = \theta$$

where,

ϕ = Phase angle of load

θ = Impedance angle of line = $\tan^{-1} \frac{X}{R}$.

Zero regulation occurs when

$$\phi_r + \theta = \frac{\pi}{2}$$

- At leading pf the regulation will generally negative but it also becomes zero provided that

$$\phi_r = \tan^{-1}(R/X) \quad \text{i.e. 0.707 power factor lead.}$$

Medium Length Transmission Line

ABCD parameter in matrix form

(a) For nominal T-circuit

$$\begin{bmatrix} V_s \\ I_s \end{bmatrix} = \begin{bmatrix} 1 + \frac{YZ}{2} & Z \left(1 + \frac{YZ}{4} \right) \\ Y & 1 + \frac{YZ}{2} \end{bmatrix} \begin{bmatrix} V_r \\ I_r \end{bmatrix}$$

(b) For nominal π -circuit

$$\begin{bmatrix} V_s \\ I_s \end{bmatrix} = \begin{bmatrix} 1 + \frac{YZ}{2} & Z \\ Y \left(1 + \frac{YZ}{4} \right) & 1 + \frac{YZ}{2} \end{bmatrix} \begin{bmatrix} V_r \\ I_r \end{bmatrix}$$

Note:

For a fix receiving end voltage the sending end voltage which is calculated in nominal- π model will be slightly high when compare to nominal-T so regulation in nominal- π is slightly high when compare to nominal-T.

Farranti Effect

When receiving end of the transmission line is operating under no load condition or lightly load condition, sending end voltage V_s is less than receiving end voltage V_r .

Long Transmission Line

ABCD parameter in matrix form

$$\begin{bmatrix} V_s \\ I_s \end{bmatrix} = \begin{bmatrix} \cosh \gamma l & Z_c \sinh \gamma l \\ \frac{1}{Z_c} \sinh \gamma l & \cosh \gamma l \end{bmatrix} \begin{bmatrix} V_r \\ I_r \end{bmatrix}$$

$$\gamma = \sqrt{ZY}$$

also,

$$\gamma = \alpha + j\beta$$

and for loss less line

$$\beta = \omega \sqrt{LC}$$

where,

l = Length of transmission line

γ = Propagation constant

α = Attenuation constant in Neper/sec.

β = Phase constant in rad/km

$$\sin \gamma l = \sqrt{YZ} \left[1 + \frac{YZ}{3!} + \frac{(YZ)^2}{5!} + \dots \right]$$

$$\cos \gamma l = 1 + \frac{YZ}{2!} + \frac{(YZ)^2}{4!} + \dots$$

Wavelength (λ)

The distance corresponding to which there is a phase changes of 2π or 360° .

$$\lambda = \frac{2\pi}{\beta}$$

Velocity of wave Propagation

$$v_c = f\lambda$$

where,

f = Frequency

λ = Wavelength

Equivalent π Circuit and ABCD Parameters

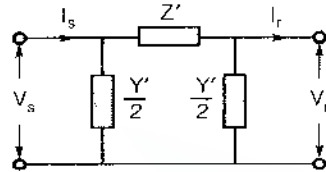

$$\begin{bmatrix} V_s \\ I_s \end{bmatrix} = \begin{bmatrix} 1 + \frac{Y'Z'}{2} & Z' \\ Y' \left(1 + \frac{Y'Z'}{4} \right) & 1 + \frac{Y'Z'}{2} \end{bmatrix} \begin{bmatrix} V_r \\ I_r \end{bmatrix}$$

where,

$$Z' = Z_c (\sinh \gamma l) = Z_c \frac{(\sinh \gamma l)}{\gamma l}$$

$$Y' = \frac{2}{Z_c} \tanh \left(\frac{\gamma l}{2} \right) = Y \frac{\tanh(\gamma l / 2)}{(\gamma l / 2)}$$

Equivalent T Circuit and ABCD Parameter

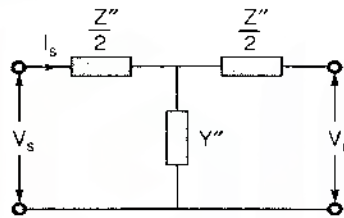

$$\begin{bmatrix} V_s \\ I_s \end{bmatrix} = \begin{bmatrix} 1 + \frac{Y''Z''}{2} & Z'' \left(1 + \frac{Z''Y''}{4} \right) \\ Y'' & 1 + \frac{Y''Z''}{2} \end{bmatrix} \begin{bmatrix} V_r \\ I_r \end{bmatrix}$$

where,

$$\frac{Z''}{2} = Z_c \left(\frac{\cosh \gamma l - 1}{\sinh \gamma l} \right) = \frac{Z_c \tanh(\gamma l / 2)}{(\gamma l / 2)}$$

$$Y'' = \frac{1}{Z_c} \sinh \gamma l = Y \frac{\sinh \gamma l}{\gamma l}$$

Note:

The equivalence is valid for only one frequency and only for the terminal conditions.

Power for Transmission Lines

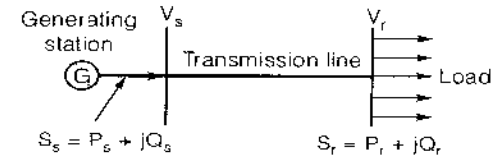

(A two bus power system)

Let $V_s = |V_s| \angle \delta, V_r = |V_r| \angle 0$

$D = A = |A| \angle \alpha, B = |B| \angle \beta$

□ Complex power per phase at the receiving end

$$S_r = \frac{|V_s||V_r|}{|B|} \angle(\beta - \delta) - \frac{|A||V_r|^2}{|B|} \angle(\beta - \alpha)$$

Surge Impedance

The impedance of transmission line with losses, is known as characteristic impedance (Z_c) and the impedance of transmission line without losses is known as surge impedance (Z_s) or natural impedance (Z_n)

$$Z_c = \sqrt{\frac{Z}{Y}} = \sqrt{\frac{R + j\omega L}{G + j\omega C}}$$

$$Z_c = \sqrt{\frac{B}{C}} = \sqrt{Z_{OC} Z_{SC}}$$

where, Y, Z = Shunt admittance and series impedance per unit length respectively

Z_{OC} = Open circuit impedance

Z_{SC} = Short circuit impedance

For lossless transmission line $R = 0, G = 0$

$$Z_s = \sqrt{\frac{L}{C}}$$

Note:

Surge impedance does not depend upon length of the line.

Remember:

- $Z_c = 400 \Omega$ for transmission line
- $Z_c = 40 \Omega$ for cable
- Z

Flat Line (or) Infinite Line

A lossless transmission line terminated with surge impedance at the receiving end is known as infinite or flat line.

Surge Impedance Loading (SIL)

The power delivered by the line to a purely resistive load equal to its surge impedance (or) the load at which the inductive and capacitive reactive voltamperes are equal and opposite, is called surge impedance loading of the line.

$$SIL = \frac{V_s V_R}{Z_s} = \frac{(kV)^2}{Z_o} \text{ MW}$$

Note:

- SIL is independent of the distance and depends on the voltage.
- SIL is always less than the rated capacity of a line.
- If load on line is < SIL then power factor will be leading.
- If load on line is > SIL then power factor will be lagging.
- If load on line is = SIL then power factor will be unity.

Transmission Line Connection

1. Transmission Line Connected Either in Series or Cascaded

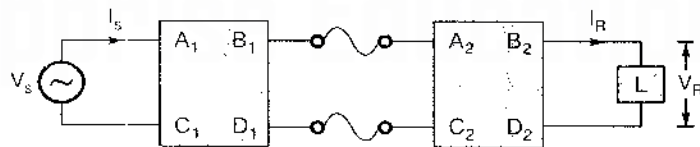

$$\begin{bmatrix} V_s \\ I_s \end{bmatrix} = \begin{bmatrix} A_1 & B_1 \\ C_1 & D_1 \end{bmatrix} \begin{bmatrix} A_2 & B_2 \\ C_2 & D_2 \end{bmatrix} \begin{bmatrix} V_R \\ I_R \end{bmatrix}$$

$$\begin{bmatrix} V_s \\ I_s \end{bmatrix} = \begin{bmatrix} A_1 A_2 + B_1 C_2 & A_1 B_2 + B_1 D_2 \\ C_1 A_2 + D_1 C_2 & C_1 B_2 + D_1 D_2 \end{bmatrix} \begin{bmatrix} V_R \\ I_R \end{bmatrix}$$

2. Transmission Line Connected in Parallel

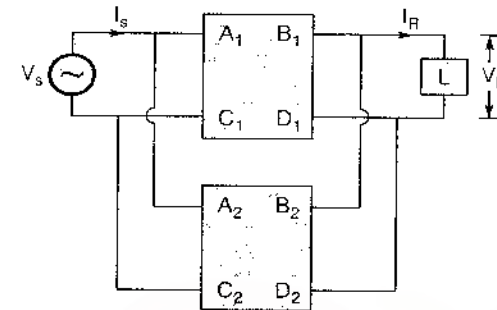

$$A = \frac{A_1 B_2 + A_2 B_1}{B_1 + B_2}$$

$$B = \frac{B_1 B_2}{B_1 + B_2}$$

$$C = (C_1 + C_2) + \frac{(D_1 - D_2)}{B_1 + B_2}$$

$$D = \frac{D_1 B_2 + D_2 B_1}{B_1 + B_2}$$

Reflection and Refraction of Waves

1. Line Terminated by an Impedance (Z)

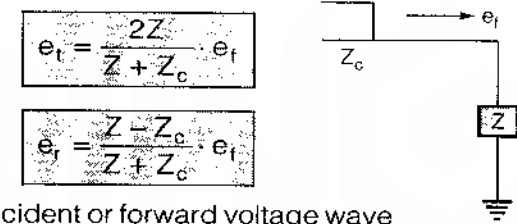

$$e_t = \frac{2Z}{Z + Z_c} \cdot e_i$$

$$e_r = \frac{Z - Z_c}{Z + Z_c} \cdot e_i$$

where, e_i = Incident or forward voltage wave
 e_t = Refracted or transmitted voltage wave
 e_r = Reflected voltage

$\frac{2Z}{Z + Z_c}$ = Refraction coefficient of a line with surge impedance Z_c terminated by an impedance Z .

$\frac{Z - Z_c}{Z + Z_c}$ = Reflection coefficient.

Transmitted current

$$I_t = \frac{2}{Z + Z_c} \cdot e_i$$

□ Reflected current

$$i_r = \frac{Z_c - Z}{Z_c + Z} i_f$$

Conditions

1. If line is terminated by a resistance, equal, to the surge impedance. then, $e_t = e_f$, $i_t = i_f$, $e_r = 0$ and $i_r = 0$
The incident wave continues as it is and there is no reflection.
2. If line is open circuited line then, $e_t = 2e_f$, $i_t = 0$, $e_r = e_f$, $i_r = -i_f$
An open circuit at the end of a line demands, that the current at that point be zero at all times.
3. If line is short circuited line then, $e_t = 0$, $i_t = 2i_f$, $e_r = -e_f$, $i_r = i_f$

Equivalent Circuit of Travelling Waves

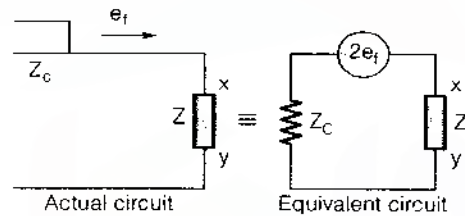

2. Forked line

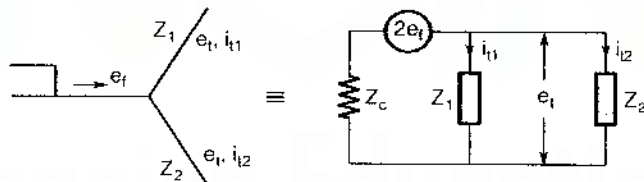

□ Refracted or Transmitted voltage

$$e_t = \frac{2e_f}{Z_c + \frac{Z_1 Z_2}{Z_1 + Z_2}} \left(\frac{Z_1 Z_2}{Z_1 + Z_2} \right)$$

□ Refracted or Transmitted currents

$$i_{t1} = \frac{e_t}{Z_1} \quad \text{and} \quad i_{t2} = \frac{e_t}{Z_2}$$

3. Line terminated by inductance

□ Transmitted current

$$i_t = \frac{2E}{Z_c} \left[1 - \exp\left(-\frac{Z_c t}{L}\right) \right]$$

where, E = A step wave travelling on a line of surge impedance Z_c

□ Transmitted voltage

$$e_t = 2E \cdot \exp\left(-\frac{Z_c t}{L}\right)$$

□ Reflected voltage

$$e_r = E \left[2 \exp\left(-\frac{Z_c t}{L}\right) - 1 \right]$$

□ Reflected current

$$i_r = \frac{E}{Z_c} \left[1 - 2 \exp\left(-\frac{Z_c t}{L}\right) \right]$$

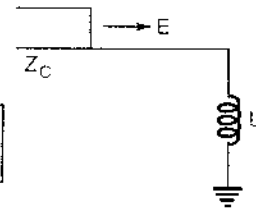

4. Line Terminated by Capacitance

□ Transmitted current

$$i_t = \frac{2E}{Z_c} \exp\left(-\frac{t}{CZ_c}\right)$$

□ Transmitted voltage

$$e_t = 2E \left[1 - \exp\left(-\frac{t}{CZ_c}\right) \right]$$

□ Reflected voltage

$$e_r = E \left[1 - 2 \cdot \exp\left(-\frac{t}{CZ_c}\right) \right]$$

□ Reflected current

$$i_r = \frac{E}{Z_c} \left[2 \exp\left(-\frac{t}{CZ_c}\right) - 1 \right]$$

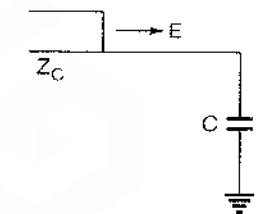

Concept of Corona

4

Corona

The complete disruption in dielectric strength or insulation of insulating material (air) near the surface of the conductor at certain point is called as concept of corona. Corona occurs only when the electric field intensity is greater than dielectric strength of air.

In general corona occurs around the power conductor due to two reasons:

- (i) Electrical power transmission is at higher operating voltages.
- (ii) Number of free electrons in the space surrounding the power conductor are more due to radio activity.

Critical Disruptive Voltage (V_d)

The voltage at which self field intensified localised ionization of air takes place is called as critical disruptive voltage (V_d).

Visual Critical Voltage

The voltage at which the visual corona begins is known as visual critical voltage. Visual glow of corona occurs at a voltage higher than the critical disruptive voltage.

Critical Voltage & Intensity

Relative density of air

$$\delta = \frac{p}{76} \left(\frac{273 + \theta_0}{273 + \theta} \right)$$

where, p = Barometric pressure, cm

θ = Temperature, °C

Assume relative density at θ_0 °C and 76 cm of Hg as 1

Critical Intensity

$$E_0 = \left(\frac{3 \times 10^6}{\sqrt{2}} \right) \delta \cdot m_0 \text{ V/m}$$

where, E_0 = Rms value of critical intensity

δ = Relative density of air

m_0 = Roughness factor

Note:

- For smooth conductors of large diameter in air at normal temperature and pressure corona begins at peak value of critical field intensity 30 kV/cm.
- $m_0 = 1.0$ for smooth conductors and 0.93 to 0.98 for rough conductors exposed to atmosphere.

Disruptive Critical Voltage.

(a) For 1- ϕ line

$$V_d = \frac{6 \times 10^6}{\sqrt{2}} r \delta m_0 \ln \frac{D}{r} \text{ Volts}$$

where, D = Spacing between conductors, in metres.

r = Radius of conductor, in metres.

V_d = Critical disruptive voltage, in volts

(b) For 3- ϕ line

$$V_d = \frac{3 \times 10^6}{\sqrt{2}} r \delta m_0 \ln \left(\frac{D_{eq}}{r} \right) \text{ Volts}$$

where, D_{eq} = Equivalent spacing between conductor, in metres.

Visual Critical Intensity

$$E_v = \frac{3 \times 10^6}{\sqrt{2}} \delta m_v \left(1 + \frac{0.03}{\sqrt{\delta r}} \right) \text{ V/m}$$

where, m_v = Irregularity Factor

Visual Critical voltage

(a) For 1- ϕ line

$$V_v = \frac{6 \times 10^6}{\sqrt{2}} r \delta m_v \left(1 + \frac{0.03}{\sqrt{\delta r}} \right) \ln \frac{D}{r} \text{ Volts}$$

(b) For 3- ϕ line

$$V_v = \frac{3 \times 10^6}{\sqrt{2}} r \delta m_v \left(1 + \frac{0.03}{\sqrt{\delta r}} \right) \ln \frac{D_{eq}}{r} \text{ Volts}$$

where, m_v = Irregularity factor V_v = Visual critical voltage**Corona Loss****1. Peek's Formula (under fair weather conditions)**

$$P_c = 243.5 \frac{(f+25)}{\delta} \sqrt{\frac{r}{D}} \cdot (V - V_d)^2 \times 10^{-5} \text{ kW/km/phase}$$

where, V = Phase voltage, in kV (rms value) V_d = Disruptive critical voltage in kV (rms value) r = Radius of conductor, in metres f = System frequency**Note:**Under stormy weather conditions use V_d as 80% of its fair weather value.**2. Peterson's Formula**

$$P_c = \frac{21 \times 10^{-6} f V^2}{\left[\log_{10} \left(\frac{D}{r} \right) \right]^2} \times F \text{ kW/phase/km}$$

where, F = Factor which varies with the ratio (V/V_d) .**Remember:**Peek's formula is used for ratio (V/V_d) greater than 1.8 and Peterson's formula is used for ratio less than 1.8.**Disadvantages of Corona**

- There is certain real power loss in the form of corona loss.
- Corona causes an interference with the neighbouring communication line.

Advantage of Corona

The corona will act as a safety wall to the transmission line conductors against lightning stroke, in which the peak magnitude of lightning surge will dissipate in the form of corona loss.

Method to Reduce Corona

- By the use large size of conductor.
- Use bundle conductor.
- Use hollow conductor.

Remember:

- In 400/220 kV substation bus bar are in the form of hollow tube.
- DC corona loss = $\frac{1}{3}$ AC corona loss (for same line voltage).



Mechanical Design of Overhead Lines

5

2. Effect of Ice and Wind

Weight of Ice Per Metre Length of Conductor

$$W_i = 2.8 \times 10^4 t(d + t) \text{ N/m}$$

where, d = diameter of conductor, metres
 t = radial thickness of ice, metres

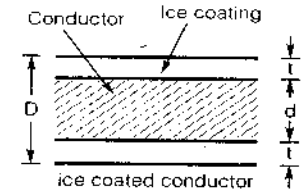

Wind load

$$F_w = P \times D \text{ N/m}$$

where, P = Wind pressure, Newton per square metre of projected area.

Total force acting on conductor per metre length

$$F_t = \sqrt{(W + W_i)^2 + F_w^2} \text{ N/m}$$

Sag under worst condition

$$S = \frac{F_t l^2}{8T} \text{ in new plane}$$

where, F_t = Total force per meter
 T = Limiting tension

Vertical sag

$$\text{Vertical sag} = S \cos \gamma$$

$$\tan \gamma = \frac{F_w}{W + W_i}$$

Total length of conductor

$$Z = l \left(\frac{F_t^2 l^2}{24T^2} \right)$$

where, Z = Total length of the conductor
 F_t = Total force acting on conductor per metre length

SAG and Tension

SAG

The vertical distance between the conductor at the mid point and the line joining the two adjacent level support is known as sag.

Catenary

A line conductor of uniform cross-section and material, perfectly flexible but stretched inelastic between 2 support hanging freely under its own weight is represented by a curve known as catenary.

Sag Calculation

1. Supports at Same Level

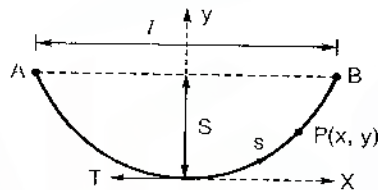

$$\text{Sag, } S = \frac{Wl^2}{8T} \text{ m}$$

where, l = Length of span, metres
 S = Sag at mid span, metres
 T = Conductor tension (assumed constant over the whole span), newtons
 W = Conductor weight, N/m

Spacing Between Conductors (without sparking)

$$\text{Spacing} = \sqrt{S} + \frac{V}{150} \text{ metres}$$

where, S = sag in metres
 V = line voltage in kV

3. Supports at different levels

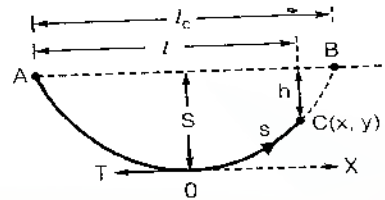

$$S = \frac{Wl_c^2}{8T} \quad \text{and} \quad l_c = l + \frac{2Th}{Wl}$$

where, l_c = Span of complete parabola

Remember:

The formulas are also valid if two supports A and C fall on the same side of

origin (i.e. if $l < \frac{l_c}{2}$).



Balanced and Unbalanced Faults

6

Per Unit System

When the power network consist of more than one equipment having different rating, the network is analysed by modelling all equipment as a single model, so that the number of network equation to be solved is only one so that time required to solve the problem will be less.

$$\text{Per unit value} = \frac{\text{Actual value in some units}}{\text{Base or reference value in same units}}$$

Note:

In transformer primary side p.u. reactance is always equal to secondary side p.u. reactance.

Remember:

- Out of 4-system quantities (kVA, kV, current and impedance) only two are independent. It is convenient to select the base value of kVA and kV and calculate the base values of other two.
- Ratio of 2-base unit give another base quantity

$$\frac{V_{\text{base}}}{I_{\text{base}}} = Z_{\text{base}}$$

- In transformer primary side p.u. reactance is always equal to secondary side p.u. reactance.

□ Base Current

$$\text{Base current} = \frac{\text{Base kVA}}{\sqrt{3} \times \text{Base kV}} \quad \text{A (in 3-}\phi \text{ system)}$$

□ Base Impedance

$$\text{Base impedance} = \frac{\text{Line to neutral value of base voltage}}{\text{Base current}}$$

$$\text{Base impedance} = \frac{(\text{Base kV})^2}{\text{Base MVA}} \quad \Omega$$

□ Per unit reactance

$$X_{pu} = X_{(actual)} \frac{I_{base}}{V_{base}}$$

$$X_{pu} = X_{(actual)} \frac{(MVA)_{base}}{(kV)_{base}^2}$$

• Per unit impedance referred to new base

$$= \left[\text{Per unit impedance referred to old base} \right] \left[\frac{\text{Base kV}_{old}}{\text{Base kV}_{new}} \right]^2 \left[\frac{\text{Base kVA}_{new}}{\text{Base kVA}_{old}} \right]$$

□ Short circuit kVA

$$\text{Short circuit kVA} = \text{Rated or base kVA} \times \frac{100}{\%Z}$$

$$EI_{sc} = EI \times \frac{100}{\%Z}$$

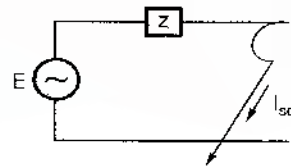

where,

E = Rated voltage

I = Rated current

Z = Internal impedance

Symmetrical Components

- A positive sequence, set of three symmetrical voltages (i.e. all numerically equal and all displaced from each other by 120°) having the same sequence 'abc' as the original set and denoted by V_{a1} , V_{b1} and V_{c1} .
- A negative sequence, set of three symmetrical voltages having the phase sequence opposite to that of the original set and denoted by V_{a2} , V_{b2} and V_{c2} .
- A zero sequence, set of three voltages, all equal in magnitude and in phase with each other and denoted by V_{a0} , V_{b0} and V_{c0} .

$$\begin{aligned} V_a &= V_{a1} + V_{a2} + V_{a0} \\ V_b &= V_{b1} + V_{b2} + V_{b0} \\ V_c &= V_{c1} + V_{c2} + V_{c0} \end{aligned}$$

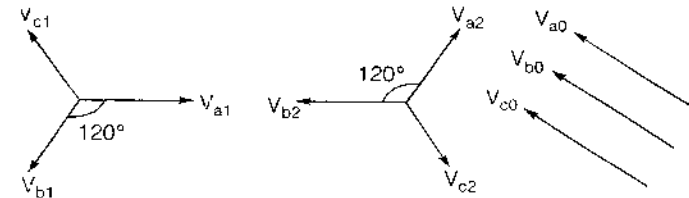

where, V_a, V_b, V_c are the three-phase voltages

$$\begin{aligned} V_{b1} &= \alpha^2 V_{a1} & V_{c1} &= \alpha V_{a1} \\ V_{b2} &= \alpha V_{a2} & V_{c2} &= \alpha^2 V_{a2} \\ V_{b0} &= V_{a0} & V_{c0} &= V_{a0} \end{aligned}$$

where, Operator $\alpha = 1 \angle 120^\circ$

Phase voltages in matrix form

$$\begin{bmatrix} V_a \\ V_b \\ V_c \end{bmatrix} = \begin{bmatrix} 1 & 1 & 1 \\ 1 & \alpha^2 & \alpha \\ 1 & \alpha & \alpha^2 \end{bmatrix} \begin{bmatrix} V_{a0} \\ V_{a1} \\ V_{a2} \end{bmatrix}$$

$$[V_{abc}] = [A][V_{012}] \quad [V_{012}] = [A]^{-1}[V_{abc}]$$

$$\text{where, } A = \begin{bmatrix} 1 & 1 & 1 \\ 1 & \alpha^2 & \alpha \\ 1 & \alpha & \alpha^2 \end{bmatrix} \quad \text{and } A^{-1} = \frac{1}{3} \begin{bmatrix} 1 & 1 & 1 \\ 1 & \alpha & \alpha^2 \\ 1 & \alpha^2 & \alpha \end{bmatrix}$$

Complex Power

Total complex power in a 3- ϕ circuit

$$S = [V_{abc}]^T [I_{abc}] = 3 [V_{012}]^T [I_{012}]$$

where, $[V_{012}]$ = Symmetrical component matrix

$[V_{abc}]$ = Unsymmetrical phasor matrix

$$[Z_{012}] = [A]^{-1} [Z_{abc}] [A]$$

Remember:

For almost all power system components the matrix $[Z_{abc}]$ is not diagonal but possess certain symmetries. These symmetries are such that $[Z_{012}]$ is diagonal either exactly or approximately.

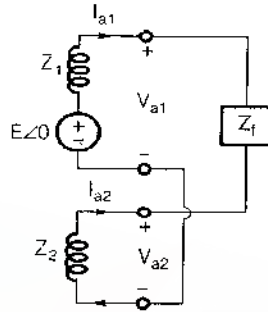
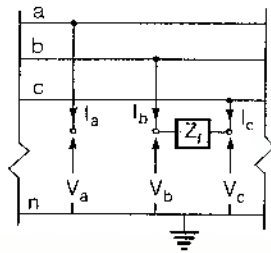

□ Fault current

$$I_f = I_b = -I_c = \frac{-j\sqrt{3}E}{Z_1 + Z_2 + Z_f}$$

Double line to ground fault (LLG fault)

Terminal conditions

$$I_a = 0, V_b = V_c = (I_b + I_c)Z_f$$

$$I_{a1} = \frac{E}{Z_1 + \frac{Z_2(Z_0 + 3Z_f)}{Z_2 + Z_0 + 3Z_f}}$$

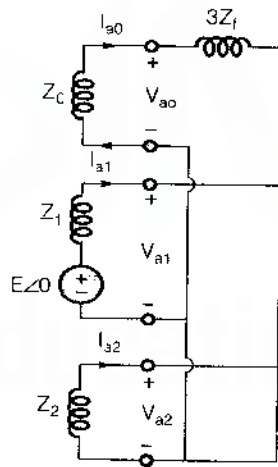
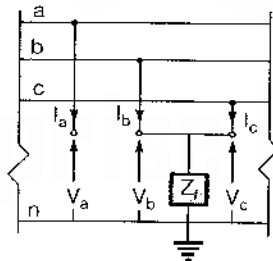

□ Fault Current

$$I_f = I_b + I_c$$



Power System Stability

Power system stability can be defined as the ability of alternators maintaining synchronism after the disturbance, which are working parallel. Power system stability problem is appearing in power system due to large variation in inertia of electrical machine.

Stability Limit

The maximum amount of power that can be transfer to the point of disturbance, to maintain the stability is known as stability limit.

Note:

- Steady state stability limit is always more than transient stability limit.
- Transient stability limit can be improved maximum upto steady state stability limit.
- A system with high steady state stability limit is not guarantee for high transient stability limit, however a system with high transient stability limit is guarantee for high steady state stability limit.

Generator Power Output

Complex Power Output of Generator

$$S = \frac{E|V|}{X_d} \sin \delta + j \left[\frac{E|V|}{X_d} \cos \delta - \frac{|V|^2}{X_d} \right]$$

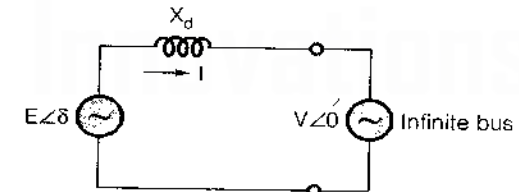

where, X_d = Direct axis synchronous reactance of synchronous machine

$E = |E|∠\delta$ = voltage behind direct axis synchronous reactance of generator

V = Terminal Voltage of generator

Real Power Output of Generator

$$P_e = \frac{E|V|}{X_d} \sin \delta = P_m \sin \delta$$

Reactive Power Output of Generator

$$Q_e = \frac{E|V|}{X_d} \cos \delta - \frac{|V|^2}{X_d}$$

$$P_r = \frac{E|V|}{X_d} \cos \delta$$

where, P_r = Synchronizing power coefficient

Note:

Maximum value of δ for successful operation is 90° .

Swing Equation

It describes rotor dynamics of alternator. When ever there is an imbalance between mechanical input and electrical power output the rotor of the alternator either accelerate or decelerate.

$$M \frac{d^2 \delta}{dt^2} = P_a = P_i - P_e \quad \dots \text{Swing equation}$$

where, $M = I\omega$ = Angular momentum
 $P_i = T_i \omega$ = Mechanical power input
 $P_e = T_e \omega$ = Electrical power output
 $P_a = P - P_e$ = Accelerating power
 T_i = Mechanical input torque
 T_e = Electromagnetic output torque
 I = Moment of inertia

Stored Kinetic Energy of a Rotating Body

$$K.E = \frac{1}{2} I \omega^2 = \frac{1}{2} M \omega$$

Inertia Constant

$$H = \frac{\text{Stored energy in mega-joules}}{\text{Machine rating in MVA. (G)}}$$

Angular Momentum

$$M = \frac{GH}{\pi f} \quad \frac{\text{MJ-sec}}{\text{Elec-rad}}$$

$$M = \frac{GH}{180^\circ f} \quad \frac{\text{MJ-sec}}{\text{Elec-degree}}$$

For Multi-Machine System

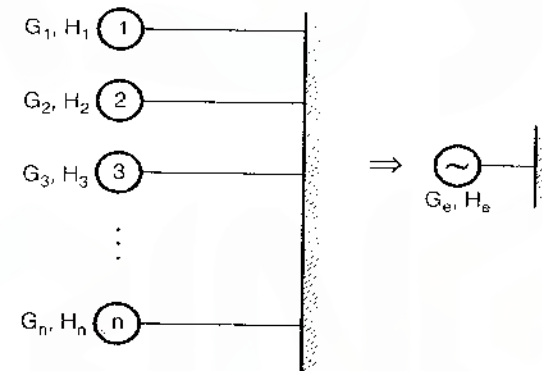

$$G_e H_e = G_1 H_1 + G_2 H_2 + G_3 H_3 + \dots + G_n H_n$$

If $G_e = G_{\text{base}}$

then,

$$H_{e(\text{p.u.})} = \frac{G_1 H_1}{G_{\text{base}}} + \frac{G_2 H_2}{G_{\text{base}}} + \dots + \frac{G_n H_n}{G_{\text{base}}}$$

(a) If n Machine Swing Together

$$M_{\text{eq}} = M_1 + M_2 + M_3 + \dots + M_n$$

(b) If n Machine Do Not Swing Together

$$\frac{1}{M_{\text{eq}}} = \frac{1}{M_1} + \frac{1}{M_2} + \frac{1}{M_3} + \dots + \frac{1}{M_n}$$

Steady State Stability Limit (P_{SSSL})

$$P_{SSSL} = \frac{EV}{X_{eq}}$$

Note:

For better steady state stability margin a power system maintain $\delta = 30$ to 40° .

Method to Improve Steady State Stability

- Operate system at high voltage. A 400 kV line has highest steady state power limit.
- Reduce the transfer reactance (X_{eq}) by
 - (a) using parallel lines
 - (b) using bundle conductor
 - (c) using series capacitor

Transient Stability

It is the ability of synchronous machine to deliver maximum power to the load, without losing synchronism for sudden and large disturbance, which is characterised as 3 ϕ S.C. fault for few cycles.

Transient Stability Evaluation Using Equal Area Criteria

- Equal area criteria is a graphical method.
- It gives absolute stability of the machine.
- It can applied only for single machine connected to infinite bus system.
- It can not use for multi machine system.

For stability

$$\text{Accelerating area} = \text{Decelerating area}$$

Note:

A power system can not have steady state stability beyond $\delta = 90^\circ$, however it can have transient stability beyond $\delta = 90^\circ$ as long as the condition of equal area criteria is satisfy.



Power System Transients

Transient in Simple Circuits

The transients will depend upon the driving source, whether it is d.c. source or an a.c. source

DC Source

1. Resistance only

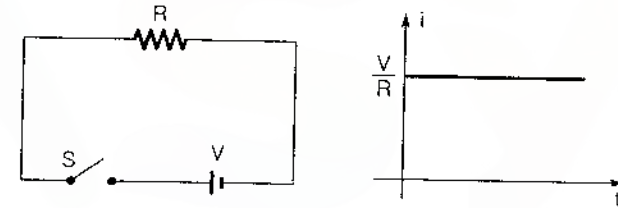

Transient current:

$$I = \frac{V}{R}$$

2. Inductance only

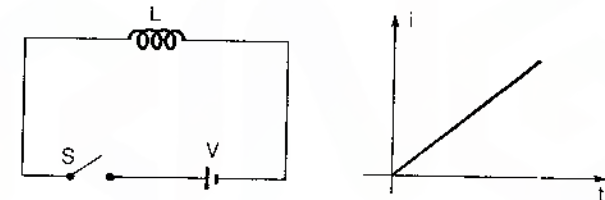

Transient current:

$$i(t) = \frac{V}{L} t$$

3. Capacitance only

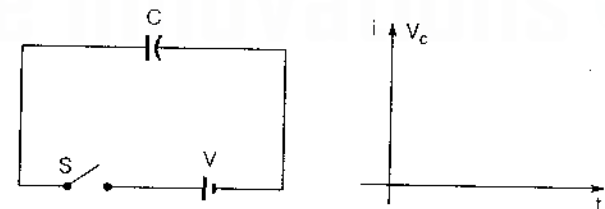

Transient current:

$$I(s) = \frac{V(s)}{Z(s)} = \frac{V}{s} \cdot sC = VC$$

which is an impulse of magnitude VC.

4. R-L circuit

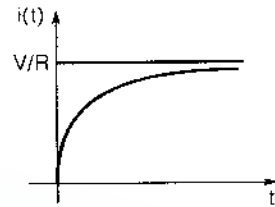
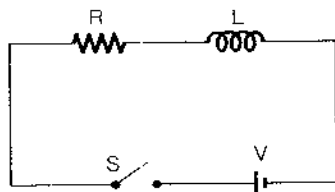

Transient current:
$$i(t) = \frac{V}{R} \left[1 - \exp\left(-\frac{R}{L}t\right) \right]$$

5. R-C circuit

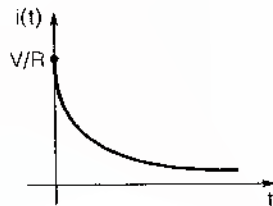
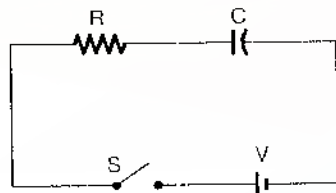

Transient current:
$$i(t) = \frac{V}{R} \exp\left(-\frac{t}{RC}\right)$$

6. R-L-C circuit

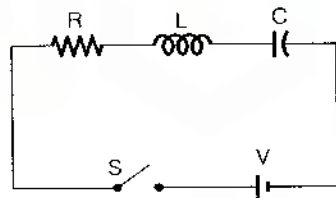

Transient current

$$i(t) = \frac{V}{2bL} \left[e^{-(a-b)t} - e^{-(a+b)t} \right]$$

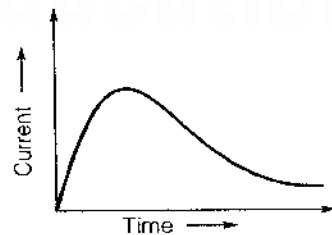

where, $a = \frac{R}{2L}$ and $b = \sqrt{\frac{R^2}{4L^2} - \frac{1}{LC}}$

(a) Case-1

When b is real

then
$$\frac{R^2}{4L^2} > \frac{1}{LC}$$

and
$$i(t) = \frac{V}{2bL} \left[e^{-(a-b)t} - e^{-(a+b)t} \right]$$

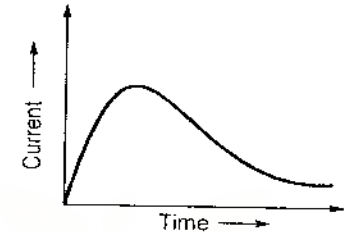

(b) Case-2

When b = 0

$$i(t) = \frac{V}{2bL} (e^{-at} - e^{-at})$$

which is indeterminate form or $\left(\frac{0}{0}\right)$ form

$$i(t) = \frac{V}{L} t e^{-at}$$

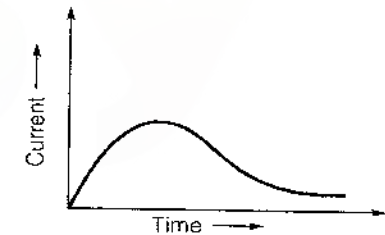

(c) Case-3

When b is imaginary

then
$$\frac{1}{LC} > \frac{R^2}{4L^2}$$

and
$$i(t) = \frac{V}{2bL} e^{-at} \cdot 2 \sin kt$$

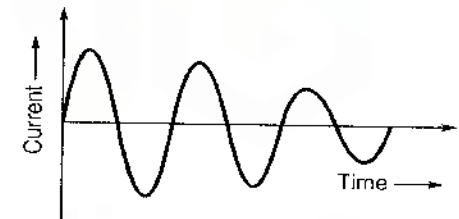

where, $k = \sqrt{\frac{1}{LC} - \frac{R^2}{4L^2}}$



Economic Load Dispatch



It deals with allocation of the loads amongst the various units in the service, in such a way that total cost of the generation is minimum. Economic scheduling is an optimization problem.

Objective function: $\text{Min}(\sum C_i(P_i))$ subjected to the satisfaction of equality/inequality constraints.

□ KVA loading on Generator = $\sqrt{P_p^2 + Q_p^2}$

where, P_p = Generator active power
 Q_p = Generator reactive power

Generator Constraints

- KVA loading on a generator should not exceed a prespecified value C_p because of the temperature rise condition.

$$P_p^2 + Q_p^2 \leq C_p^2$$

- Maximum active power generation of a source is limited by thermal consideration and minimum power generation is limited by the flame instability of a boiler.

$$P_{p,\min} \leq P_p \leq P_{p,\max} \quad Q_{p,\min} \leq Q_p \leq Q_{p,\max}$$

where, $P_{p,\min}, P_{p,\max}$ = Minimum and maximum active power generation of a source.

$Q_{p,\min}, Q_{p,\max}$ = Minimum and maximum reactive power generation of a source.

Incremental Fuel Rate

The ratio of small change in input to the corresponding small change in output is called **incremental fuel rate**.

$$\text{Incremental fuel rate} = \frac{d(\text{input})}{d(\text{output})} = \frac{dF}{dP}$$

where, F = Fuel input (Btu/hr)
 P = Power output (W)

□ Incremental efficiency = $\frac{dP}{dF}$

Economic Dispatch

1. Optimum Load Dispatch by Neglecting Losses

Economic dispatch problem is defined as

$$\text{Min } F_T = \sum_{k=1}^n F_k$$

Subject to

$$P_D = \sum_{k=1}^n P_k$$

where, F_T = Total fuel input to the system
 F_k = Fuel input to K^{th} unit
 P_D = Total load demand
 P_k = Generation of K^{th} unit

- Auxiliary function

$$F = F_T + \lambda \left(P_D - \sum_{k=1}^n P_k \right)$$

Condition for optimum operation

$$\frac{dF_1}{dP_1} = \frac{dF_2}{dP_2} = \dots = \frac{dF_n}{dP_n} = \lambda$$

where, λ = Lagrangian multiplier

$\frac{dF_n}{dP_n}$ = incremental production cost of plant n

$$\frac{dF_n}{dP_n} = F_{nn} P_n + f_n$$

where, F_{nn} = Slope of incremental production cost curve
 f_n = Intercept of incremental production cost curve.

2. Optimum Load Dispatch Including Transmission Losses.

Optimal load dispatch problem is defined as

$$\text{Min } F_T = \sum_{k=1}^n F_k$$

Subject to

$$P_D + P_L - \sum_{k=1}^n P_k = 0$$

where,

P_L = Total loss

- Auxiliary function

$$F = F_T + \lambda(P_D + P_L - \Sigma P_n)$$

- Co-ordination equations

Condition for optimal load dispatch

$$\frac{dF_n}{dP_n} + \lambda \frac{\partial P_L}{\partial P_n} = \lambda$$

where, $\frac{\partial P_L}{\partial P_n}$ = Incremental transmission loss at plant n
 λ = Incremental cost of received power

Loss Formulae:

- Total Losses

$$P_L = \sum_m \sum_n P_m B_{mn} P_n$$

where, P_m, P_n = Source loadings
 B_{mn} = Transmission loss coefficients

- Incremental Transmission Losses

$$\frac{\partial P_L}{\partial P_n} = 2 \sum_m B_{mn} P_m$$

- Incremental Production Cost

$$\frac{dF_n}{dP_n} = F_{mn} P_n + f_n$$

$$P_n = \frac{1 - \frac{f_n}{\lambda} - 2 \sum_{m \neq n} B_{mn} P_m}{\frac{F_{nn}}{\lambda} + 2B_{nn}}$$

- Penalty Factor

$$L_n = \frac{1}{1 - \frac{\partial P_L}{\partial P_n}}$$

where, L_n = Penalty factor of plant n

Underground cable

10

An underground cable consist of three component

- Conductor or core:** It provides conducting path for the current.
- Dielectric or insulator:** Dielectric withstands operating voltage and isolates conductor from the remaining objects.
- Sheath:** Sheath does not allow the moisture content and protect conductor from electro chemical factor.

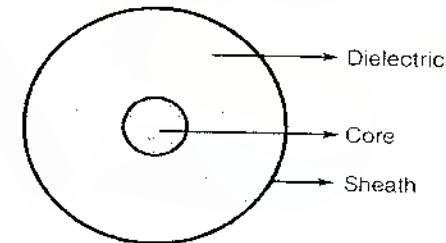

Note:

The most commonly used dielectrics in power cables are impregnated paper, butyl, rubber, PVC, polythene, cross linked polyethylene.

Classification of Cable

1. Based on Voltage

- Low voltage (LV) : 1 kV
- High voltage (HV) : 11 kV
- Super voltage (SV) : 22 kV-33 kV
- Extra high voltage (EHV) : 66 kV
- Extra super voltage (ESV) : 132 kV and above.

2. Based on Core

- Single core
- 3-core
- 3.5 core : it is used for secondary distribution purpose.

Parameters of Single Core Cables

Resistance

□ Insulation Resistance

$$R_{ins} = \frac{\rho}{2\pi} \ln\left(\frac{R}{r}\right) \text{ ohms/metre}$$

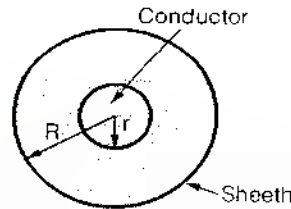

where, R_{ins} = Insulation Resistance
 ρ = Resistivity of the insulating material
 R = Inside radius of sheath
 r = Conductor radius

□ Resistivity of insulating material at any temperature t

$$\rho_t = \rho_0 e^{-\alpha t}$$

Note:

- In cable, insulation resistance is inversely proportion to length of the cable

$$R_{ins} \propto \frac{1}{l}$$

- As temperature increases R_{ins} decreases.

Capacitance

□ Capacitance between core and sheath

$$C = \frac{2\pi \epsilon_0 \epsilon_r l}{\ln\left(\frac{R}{r}\right)} \text{ F/m}$$

where, q = Charge on the surface of the conductor per metre length of cable.
 ϵ_r = Relative permittivity of dielectric

□ Dielectric loss

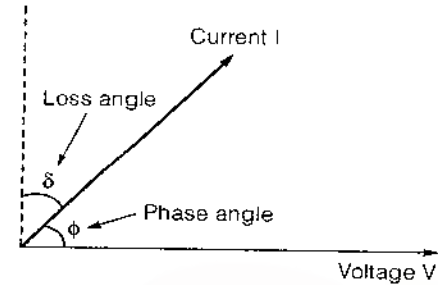

$$P_d = VI \cos \phi = \omega CV^2 \delta$$

where, C = Capacitance of the cable
 V = Line to neutral voltage
 P_d = Dielectric loss

Electrostatic Stresses

Gradient at a Distance x from the Centre of the Conductor Within the Dielectric Material.

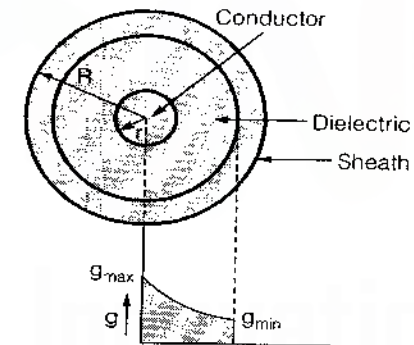

(Electric stress in a single core cable)

$$g = \frac{\lambda}{2\pi \epsilon x} = E$$

where, ϵ = Permittivity of the dielectric
 E = Electric field intensity
 λ = Charge per unit length

Potential

$$V = \frac{\lambda}{2\pi\epsilon} \ln\left(\frac{R}{r}\right)$$

where, r = Radius of conductor
 R = Inner radius of the sheath
 V = Potential of conductor with respect to the sheath

Gradient is Maximum at the Surface of the Conductor

$$g_{\max} = \frac{V}{r \ln \frac{R}{r}}$$

Gradient is Minimum at the Inner Radius of the Conductor

$$g_{\min} = \frac{V}{R \ln \frac{R}{r}}$$

Note:

- The most economical size of the cable is one in which $\frac{R}{r} = e = 2.718$. So that the stress at the surface of core is reduce which will increase the life of cable.
- Reason of failure of cable is formation of a void between any 2 layers of insulating material. Void near the surface of core will be more serious than that of the void in other location.
- Characteristic impedance of cable is 40Ω .
- In overhead transmission line inductor is dominant but in cable capacitance is more dominant.

Grading of Cables

The electrostatic stress in a single core cable has maximum value g_{\max} at the conductor surface and decreases as we move towards sheath. The method of equillising the stress in the dielectric of the cable is known as grading of cable.

1. Dielectric Grading (or) Capacitance Grading

In dielectric grading a homogeneous dielectric is replaced by different dielectrics such that

$$r < r_1 < r_2$$

So,

$$\epsilon_1 > \epsilon_2 > \epsilon_3$$

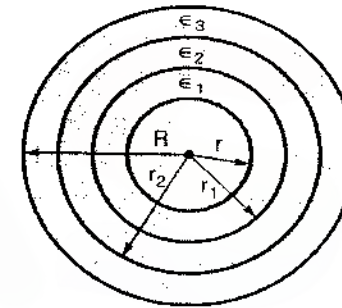

The voltage between conductor and sheath

$$V = V_1 + V_2 + V_3$$

$$V = g_{1\max} r \ln\left(\frac{r_1}{r}\right) + g_{2\max} r_1 \ln\left(\frac{r_2}{r_1}\right) + g_{3\max} r_2 \ln\left(\frac{R}{r_2}\right)$$

For uniform dielectric stress

$$g_{1\max} = g_{2\max} = g_{3\max} = g_{\max}$$

$$V = g_{\max} \left[r \ln\left(\frac{r_1}{r}\right) + r_1 \ln\left(\frac{r_2}{r_1}\right) + r_2 \ln\left(\frac{R}{r_2}\right) \right]$$

Capacitance of the cable

$$C = \frac{2\pi\epsilon_0}{\frac{1}{\epsilon_1} \ln\left(\frac{r_1}{r}\right) + \frac{1}{\epsilon_2} \ln\left(\frac{r_2}{r_1}\right) + \frac{1}{\epsilon_3} \ln\left(\frac{R}{r_2}\right)}$$

2. Intersheath grading

In intersheath grading an identical dielectric material is utilised throughout the total thickness of the cable. It is divided into 2 or more layers by providing intersheath.

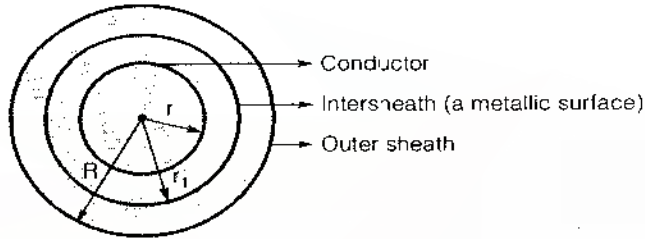

- Voltage between conductor and outer sheath (for uniform potential gradient i.e. $g_{1\max} = g_{2(\max)} = g_{\max}$)

$$V = g_{\max} \left[r \ln \left(\frac{r_1}{r} \right) + r_1 \ln \left(\frac{R}{r_1} \right) \right]$$

- Condition for most economical cable for intersheath grading.

$$V_1 = \frac{V}{e}$$

where, V_1 = Voltage between conductor and intersheath
 V = Voltage between conductor and sheath

- Most economical radius of conductor

$$r = \frac{V_1}{g_{\max}} = \frac{V}{eg_{\max}}$$

- Most economical radius of intersheath

$$r_1 = \frac{V}{g_{\max}}$$

- Most economical radius of outersheath

$$R = 1.881 \frac{V}{g_{\max}}$$



Protective Relays

Relays are sensing device, which detect abnormal conditions in electric circuit like faults and send signal to operate circuit breaker to isolate faulty equipment from the system as quickly as possible.

Types of Relay

1. Based on Time of Operation

- (i) *Instantaneous relay*: Operating time ≤ 0.1 sec.
- (ii) *Definite minimum time (DMT) Relay*:

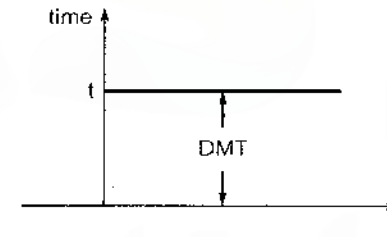

- (iii) *Inverse relay*:

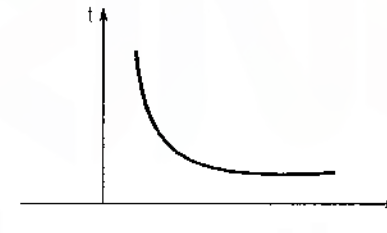

- (iv) *Inverse definite minimum time (IDMT) relay*:

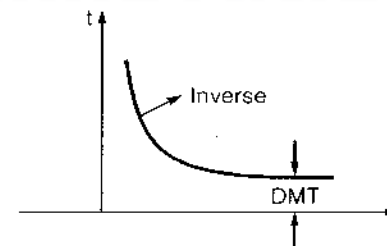

2. Based on Construction

- (i) *Electromagnetic attraction type:*
 - (a) Balanced beam type.
 - (b) Moving plunger type.
 - (c) Attracted armature type.
- (ii) *Electromagnetic induction type:*
 - (a) Shaded pole type.
 - (b) Induction cup type.
 - (c) Wattmeter type.
- (iii) *Gas operated relay:* Buchholz relay.
- (iv) *Thermal relay:* For over load protection.
- (v) *Static/microprocessor based relay.*

Pickup Value

It is minimum value of operating quantity at which relay is at the verge of operation.

Reset Value

It is maximum value of operating quantity at which relay is at the verge of non-operation.

Note:

- For Well-design relay the ratio of reset to pickup value is unity.
- For induction type relay the ratio of reset to pickup value is 0.98.

Time Multiplier Setting (TMS)

By setting different value of TMS, for the same operating current, we get different time of operation.

$$TMS_{(required)} = \frac{t_{required}}{t_{(TMS=1)}}$$

where, $t_{required}$ = Required time of operation
 $t_{(TMS=1)}$ = Time of operation when TMS = 1

$$\frac{TMS_2}{TMS_1} = \frac{t_2}{t_1}$$

Plug Setting Multiplier (PSM)

PSM gives additional feature to the same relay, so that it can operate for different pickup current

$$PSM = \frac{\text{Fault current}}{\text{Current setting} \times \left(\frac{\text{C.T. secondary}}{\text{rated current}} \right) \times \text{C.T. ratio}}$$

Torque Equation

Universal Relay Torque Equation

$$T = K_1 I^2 + K_2 V^2 + K_3 VI \cos(\theta - \tau) + K$$

where, I = RMS value of current in current coil
 V = RMS value of voltage fed to the voltage coil circuit
 θ = Angle between I and V
 τ = The maximum torque angle
 K = Restraining torque including spring and friction.
 K_1, K_2, K_3 = Relay constant

Torque Equation for Different Type of Relays

1. Over current relay

$$T_{overrelay} = K_1 I^2 - K$$

2. Directional relay

$$T = K_3 VI \cos(\theta - \tau) - K$$

3. Impedance relay

$$T = K_1 I^2 - K_2 V^2$$

For relay to operate, $Z = \frac{V}{I} < \sqrt{\frac{K_1}{K_2}}$

4. Reactance relay

$$T = K_1 I^2 - K_3 V I \sin \theta \quad \tau = 90^\circ$$

$$\text{For relay to operate, } \frac{V}{I} \sin \theta = X < \frac{K_1}{K_3}$$

5. Mho relay

$$T = K_3 V I \cos(\theta - \tau) - K_2 V^2$$

$$\text{For relay to operate, } \frac{V}{I} = Z < \frac{K_3}{K_2} \cos(\theta - \tau)$$

Note:

- Relay used for phase fault on
 - (a) Short line : Reactance relay.
 - (b) Medium line : Impedance relay.
 - (c) Long line : Mho relay
- For earth fault generally reactance relay are used.



Circuit Breakers

12

□ Restriking voltage

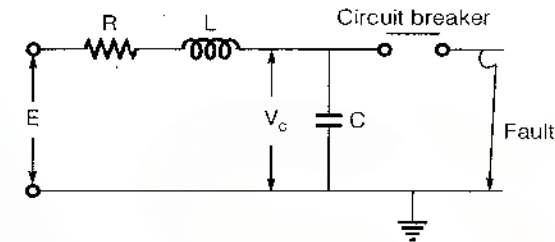

$$V = E \left(1 - \cos \frac{1}{\sqrt{LC}} t \right)$$

where, L, C = Inductance and capacitance per phase of the system upto the point of circuit breaker location.

E = System voltage at the instant of arc interruption

V = Restriking voltage

□ The maximum value of restriking voltage = $2 \times E_{\text{peak}}$

where, E_{peak} = Peak value of the system voltage

□ Natural frequency of oscillation

$$f_n = \frac{1}{2\pi} \frac{1}{\sqrt{LC}}$$

□ Rate of rise of restriking voltage (RRRV)

$$\text{RRRV} = \omega_n E \sin \omega_n t$$

□ The maximum value of RRRV = $\omega_n E_{\text{peak}}$

Resistance Switching

- Frequency of damped oscillation

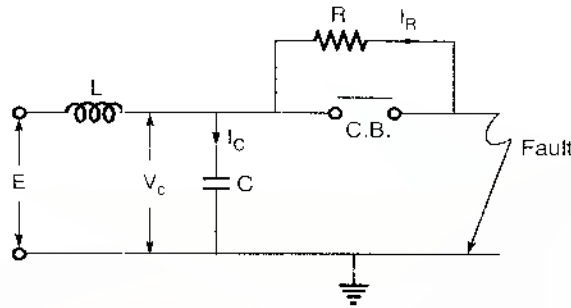

$$f = \frac{1}{2\pi} \sqrt{\frac{1}{LC} - \frac{1}{4R^2C^2}}$$

Note:

If value of the resistance connected across the contacts of circuit breaker, is equal to or less than $\frac{1}{2} \sqrt{\frac{L}{C}}$, then there will be no transient oscillation.

Transient Oscillation for Different Values of R

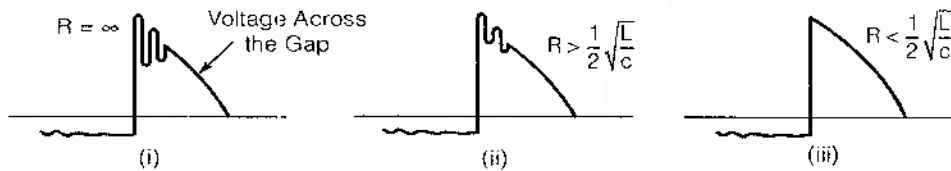

Transient oscillations for different values of R

- If $R > \frac{1}{2} \sqrt{\frac{L}{C}}$. There will be oscillation.
- $R = \frac{1}{2} \sqrt{\frac{L}{C}}$ is known as critical resistance. There will be no oscillation.



Generating Power Stations

- Water Power

$$P = \frac{0.736}{75} Q \eta H \text{ kW}$$

where, Q = Discharge; m³/sec
 H = Water head; m
 η = Overall efficiency of turbine alternator set

- Specific speed of a turbine is the speed of a scale model of turbine which develops 1 metric h.p. under a head of 1 metre.

- Specific Speed

$$N_s = \frac{N \sqrt{P_t}}{H^{1.25}}$$

where, N_s = Specific speed in metric units
 N = Speed of turbine in rpm
 P_t = Output in metric h.p.
 H = Effective head in metres

- Power output of Tidal scheme

$$P = Q \rho g H \text{ watts}$$

where, Q = Quantity of water flow, m³/sec
 g = Acceleration due to gravity = 9.81 m/sec²
 H = Water head, metre
 ρ = Density of sea water = 1025 kg/m³

Classification of Turbine

1. Based on Water Discharge

- High discharge : Kaplan
- Medium discharge : Francis
- Low discharge : Pelton

2. Based on Water Pressure

- Impulse : Pelton
- Reaction : Kaplan, Francis, Propeller

3. Base on Direction of Water Flow

- Axial : Kalpan
- Radial : Francis
- Tangential : Peltron
- Diagonal : Deriaz

Component of Hydroelectric Power Station

1. Reservoir
2. Dam
3. Trash rack
4. Spill-way
5. Gates
6. Intake gates
7. Forebay
8. Surge tank
9. Pen stock.

Component of Nuclear Power Station

1. **Reactor core:** Reactor core is made-up of stainless steel or zirconium.
2. **Moderator:** It decrease speed of neutron. (i) Heavy water, (ii) Graphite and (iii) Beryllium.
3. **Reflector:** Prevents escape of neutron from reactor core, and made-up of high grade graphite.
4. **Control rod:** During earthquake it trips the generating station.
5. **Cooler:** Na and Li are used as coolant material.
6. **Shielding:** Shielding eliminates the effect of radiation.

Component of Thermal Generating Stations

1. **Coal handling plant.**
2. **Boiler:** In boiler combustion takes place.
3. **Super heater:** In super heater steam is converted into the super heated steam.
4. **Airpreheater:** In airpreheater the atmospheric air absorb the heat of the flue gases and air at higher temperature send to boiler for effective combustion.
5. **Economizer:** In economizer water absorbs the heat of flue gases and send to boiler.
6. **Turbine:** Turbine runs by superheated steam and generate mechanical energy.
7. **Condenser:** Here steam is converted into feed water.



Loads and Load Curves

□ Demand factor

$$\text{Demand factor} = \frac{\text{Maximum demand}}{\text{Connected load}}$$

$$\text{Demand factor} < 1$$

□ Load factor

$$\text{Load factor} = \frac{\text{Average load}}{\text{Peak load}}$$

□ Group diversity factor

$$\text{Group diversity factor} = \frac{\text{Sum of individual maximum demand}}{\text{Maximum demand of the group}}$$

$$\text{Group diversity factor} > 1$$

□ Peak diversity factor

$$\text{Peak diversity factor} = \frac{\text{Maximum demand of a consumer group}}{\left(\text{Demand of the consumer group at the time of system peak demand} \right)}$$

□ Capacity factor

$$\text{Capacity factor} = \frac{\text{Average annual load}}{\text{Rated plant capacity}}$$

$$\text{Capacity factor} = \frac{\text{Maximum load}}{\text{Plant capacity}} \times \text{Load factor}$$

$$\text{Capacity factor} = \text{Load factor} \times \text{Utilisation factor}$$

□ Utilisation factor

$$\text{Utilisation factor} = \frac{\text{Maximum load}}{\text{Rated plant capacity}}$$

Remember:

- Plant capacity factor is also known as plant factor.
- A graph showing the variation of the system load during the 24 hours of the day is known as the system chronological load curve.
- The area under a chronological load curve gives the energy consumed during the 24 hours.
- Load duration curve is a rearrangement of all the load elements of a chronological curve in a descending order
- Mass curve is plotted with energy as ordinate and time as abscissa.
- A mass curve is used in the study of variations between the rate of water flow and the electrical load and determination of the necessary storage.



A Handbook on Electrical Engineering

2

Electrical Machines

CONTENTS

1. Transformers	76
2. Electromagnetic System	91
3. Basic Concepts in Rotating Electrical Machines	94
4. D.C. Machines	97
5. Polyphase Induction Motors	109
6. Polyphase Synchronous Machines	122



Transformers

1

A transformer is a static device which consists of two or more stationary electric circuits interlinked by a common magnetic circuit for the purpose of transferring electrical energy between them while keeping the frequency of operation constant.

Remember:

- Basic principal behind the transformer action is Faraday's law of electromagnetic induction.
- Transformer is a constant frequency and constant power device.

Induced EMF

Direction of induced emf can be found by "Lenz's law" and magnitude of induced emf can be given by "Faraday's law of electromagnetic induction".

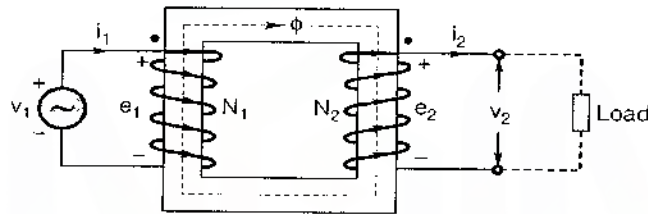

RMS value of induced Emf.

In primary winding

$$E_1 = \sqrt{2} \pi N_1 f \phi_m \text{ Volts}$$

In secondary winding

$$E_2 = \sqrt{2} \pi N_2 f \phi_m \text{ Volts}$$

- where,
- N_1 = Number of turns in primary winding
 - N_2 = Number of turns in secondary winding
 - ϕ_m = Maximum value of the magnetic flux, in webers
 - f = Supply frequency, in Hz

Remember:

- Emf per turn in primary = Emf per turn in secondary
- Compensating primary mmf = Secondary mmf

$$I_1' N_1 = I_2 N_2$$

where, I_1' = Load component of primary current I_1

- Primary volt-amperes = Secondary volt-amperes.
- Instantaneous power input into primary is equal to the instantaneous power output from the secondary.
- Step up transformer : $N_1 < N_2$.
- Step down transformer : $N_1 > N_2$.

Ideal Transformer

- The transformer core has infinite permeability. So, flux established without any magnetising current.
- The primary and secondary windings have zero resistance. So, there is no ohmic power loss and no resistive voltage drop.
- There is no magnetic leakage flux.
- The core loss considered to be zero.

Equivalent Circuit

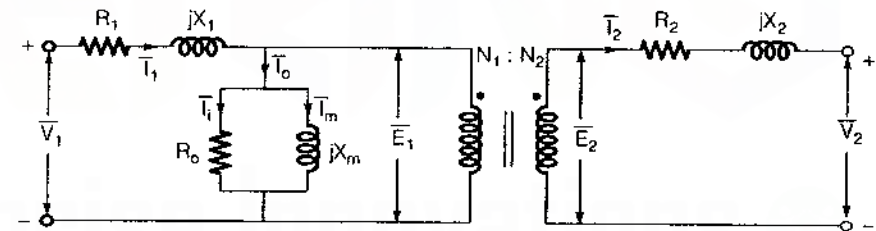

Exact equivalent circuit of transformer

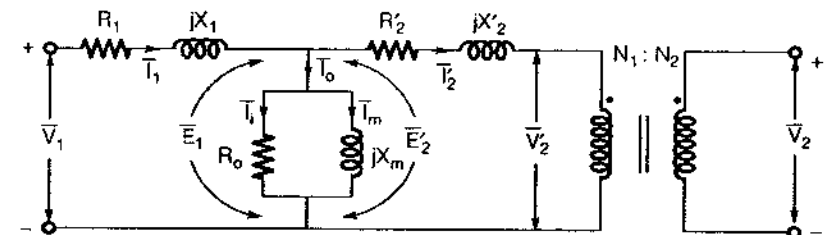

Equivalent circuit referred to primary side

where, \bar{V}_1 = Applied voltage to primary side.

\bar{V}_2' = Secondary terminal voltage referred to primary side.

\bar{E}_1, \bar{E}_2 = Induced emf in primary and secondary side.

\bar{E}_2' = Secondary induced emf referred to primary side.

\bar{I}_0 = No load current.

\bar{I}_m, \bar{I}_i = Magnetizing and core loss component of exciting current.

R_1, R_2 = Primary and secondary winding resistances.

X_1, X_2 = Primary and secondary winding leakage reactances.

R_2', X_2' = Secondary resistance and leakage reactance referred to primary side.

R_o = Core loss equivalent resistance.

X_m = Magnetising reactance.

Note:

At no load, current drawn from the supply is I_0 .

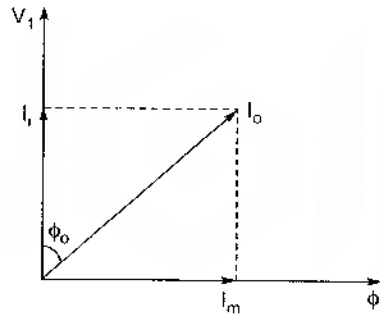

$$\bar{I}_0 = \bar{I}_m + \bar{I}_i = (2 \text{ to } 5\% \text{ of } I_{fl})$$

$$\bar{I}_m = I_0 \sin \phi_0$$

= Magnetizing current and is responsible for the production of flux.

$$\bar{I}_i = I_0 \cos \phi_0$$

= Core loss current responsible for the active power being drawn from the source to provide hysteresis and eddy current losses.

ϕ_0 = No load phase angle (80 to 85°)

Secondary Side Parameters Referred to Primary Side

• If $\frac{N_1}{N_2} = a$

- Secondary resistance referred to primary side

$$R_2' = a^2 R_2$$

- Secondary leakage reactance referred to primary side

$$X_2' = a^2 X_2$$

- Secondary current referred to primary side

$$I_2' = \frac{I_2}{a}$$

- Secondary induced emf referred to primary side

$$E_2' = a E_2$$

- Secondary terminal voltage referred to primary side

$$V_2' = a V_2$$

Basic Equations for Transformer

$$\bar{E}_1 = a \bar{E}_2$$

$$\bar{I}_0 = \bar{I}_m + \bar{I}_i$$

$$\bar{E}_2 = \bar{V}_2 + \bar{I}_2 R_2 + j \bar{I}_2 X_2$$

$$\bar{V}_1 = \bar{E}_1 + \bar{I}_1 R_1 + j \bar{I}_1 X_1$$

$$\bar{I}_1 = \frac{I_2}{a} + I_0$$

Phasor Diagram

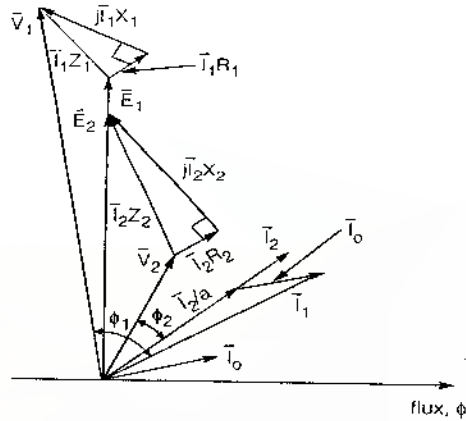

Step down transformer at lagging power factor

Note:

- $R_{01} = R_1 + R_2' =$ Equivalent resistance referred to primary side.
- $X_{01} = X_1 + X_2' =$ Equivalent reactance referred to primary side.
- $Z_{01} = \sqrt{R_{01}^2 + X_{01}^2} =$ Equivalent impedance referred to primary side.
- Core of transformer should have low reluctance and high permeability.
- It is made from CRGO (cold rolled grain oriented) material with 4% of silicon.
- It is laminated to reduce eddy current losses.

Types of Transformer Construction

1. Core type
2. Shell type

S.No.	Core type transformer	Shell type transformer
1.	Series magnetic circuit	Parallel magnetic circuit
2.	2 limb and 2 yoke	3 limb and 2 yoke
3.	Suitable for low flux density application	Suitable for high flux density application
4.	Required more amount of copper	Required less amount of copper
5.	Required less amount of insulation so suitable for high voltage and high power applications	Suitable for low voltage and lower power applications

Remember:

- Transformer windings are made up of stranded conductors instead of solid conductor.
- Low voltage windings are placed nearer to the core, for reducing insulation requirement.

Losses in Transformer

1. Copper Loss (P_{cu})

This loss is variable loss.

Total copper loss = Primary copper loss + Secondary copper loss

$P_{cu} = I_1^2 R_1 + I_2^2 R_2$

Resistance referred to any one side.

$P_{cu} = I_1^2 R_{01} = I_2^2 R_{02}$

Remember:

p.u. resistance = p.u. full load copper loss

2. Iron Loss (P_i)

This loss is constant loss.

Iron loss = Hysteresis loss + Eddy current loss

(a) Hysteresis loss (P_h)

$P_h = K_h f B_m^x$

where, K_h = Proportionality constant depends upon volume, quality of the core material and units used

B_m = Maximum flux density in the core

f = Supply frequency

x = Steinmetz exponent (value vary from 1.5 to 2.5)

But, $B_m \propto \frac{V}{f}$

(i) If $\frac{V}{f} = \text{constant}$

$$P_h \propto f$$

(ii) If $\frac{V}{f} \neq \text{constant}$

$$P_h = A V^{1.6} f^{-0.6} \quad [\text{if } x = 1.6 \text{ i.e. for silicon steel}]$$

where, $A = \text{constant}$

(b) Eddy current loss (P_e)

$$P_e = K_e f^2 B_m^2 t^2$$

where, $K_e =$ Proportionality constant depends upon volume and resistivity of the core material, thickness of laminations and units employed

$f =$ Supply frequency

$B_m =$ Maximum flux density

$t =$ Thickness of lamination

But, $B_m \propto \frac{V}{f}$

(i) If $\frac{V}{f} = \text{constant}$

$$P_e \propto f^2$$

(ii) If $\frac{V}{f} \neq \text{constant}$

$$P_e \propto V^2 \text{ or } P_e = BV^2$$

where, $B = \text{constant}$

Remember:

- The iron-loss can be reduced by reducing the core flux density which means that for the same flux, the core cross-sectional area must be increased.
- Size of distribution transformer is larger as compared to similar power transformer as iron to copper ratio of distribution transformer is higher.

(Why?)

(c) Stray load loss

It largely results from leakage flux including eddy currents in the tank walls, conductors etc.

(d) Dielectric loss

The seat of this loss is in the insulating materials particularly in transformer oil and solid insulations of high voltage transformers.

Remember:

Rating of transformer is given in kVA because constant loss is proportional to voltage and variable loss is proportional to current so total loss in transformer is proportional to volt ampere.

Open Circuit Test and Short Circuit Test

- These two tests on transformer help to determine are
 - The parameters of the equivalent circuit
 - Voltage regulation
 - Efficiency
- They help in predicting performance of transformer without actually loading it.

1. Open Circuit (OC) Test

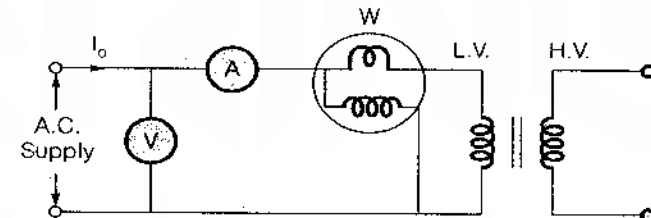

Main objectives of this test are:

- To find out parameters of no load branch i.e. R_o and X_m of equivalent circuit (shunt branch parameter).
- To find out constant losses in the transformer (i.e. core loss).

Remember:

- This test must be conducted at rated flux condition i.e. at rated voltage and rated frequency.
- This test is performed on L.V. side while H.V. side is open-circuited.

Sequence of equations used to find different parameters

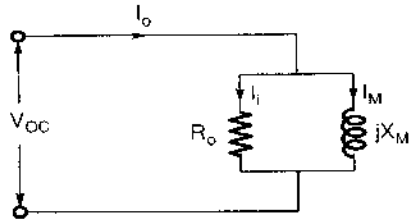

Wattmeter reading = P_i (core loss or iron loss)
 Voltmeter reading = V_{oc} (Rated voltage)
 Ammeter reading = I_o (No load current)
 No load power factor = $\cos \phi_o$

$$P_i = V_{oc} I_o \cos \phi_o$$

$$\cos \phi_o = \frac{P_i}{V_{oc} I_o}$$

$$I_i = I_o \cos \phi_o \quad \text{and} \quad I_m = I_o \sin \phi_o$$

$$R_o = \frac{V_{oc}}{I_i} \quad \text{and} \quad X_m = \frac{V_{oc}}{I_m}$$

2. Short-Circuit (SC) Test

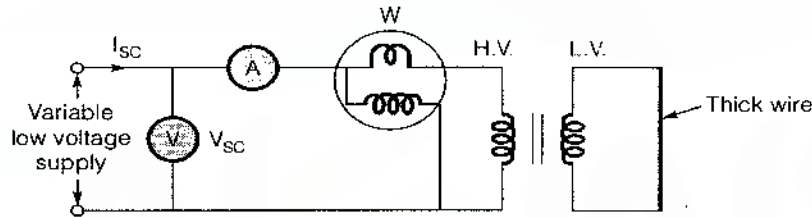

Main objectives of this test are:

- (a) To find out total resistance and reactance of transformer, when referred to the winding in which the measuring instruments are placed to conduct this test.
- (b) To find out variable losses in the transformer (i.e. copper loss).

Remember:

- This test should be conducted at rated current condition.
- This test is conducted at H.V. side while L.V. side is short circuited with a thick conductor.

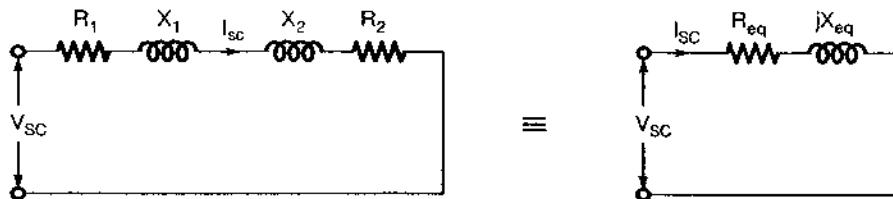

Wattmeter reading = P_{sc} (rated copper loss)
 Voltmeter reading = V_{sc}
 Ammeter reading = I_{sc} (rated current)

Sequence of equations used to find different parameters

$$R_{eq} = \frac{P_{sc}}{(I_{sc})^2}$$

$$Z_{eq} = \frac{V_{sc}}{I_{sc}}$$

$$X_{eq} = \sqrt{Z_{eq}^2 - R_{eq}^2}$$

Note:

- R_{eq} , X_{eq} and Z_{sc} are referred to high voltage side
- Power factor on short circuit $\cos \phi_{sc} = \frac{R_{eq}}{Z_{eq}}$
- Back to back or Sumpner's test is used to determine maximum temperature rise of transformer

Efficiency

$$\text{Efficiency } (\eta) = \frac{\text{Output power}}{\text{Input power}} = \frac{\text{Output}}{\text{Output} + \text{losses}}$$

$$(\eta)_{\text{Full-load}} = \frac{(kVA)_{fl} \cos \phi}{(kVA)_{fl} \cos \phi + P_i + (P_{cu})_{fl}}$$

where, P_i = Core loss or iron loss
 $(P_{cu})_{fl}$ = Full load copper loss

Note:

Efficiency at any fraction 'x' of full load

$$(\eta)_x \cdot \text{Full load} = \frac{x(kVA)_{fl} \cos \phi}{x(kVA)_{fl} \cos \phi + P_i + x^2(P_{cu})_{fl}}$$

Condition for Maximum Efficiency

$$\text{Copper loss} = \text{Iron loss}$$

$$I_{\eta_{\max}} = \sqrt{\frac{P_i}{R_{\text{eq}}}}$$

KVA load for Maximum Efficiency

$$S_{\eta_{\max}} = S_{(\text{known load})} \cdot \sqrt{\frac{P_i}{P_{\text{cu}(\text{known load})}}}$$

where, $S_{\eta_{\max}}$ = KVA rating at maximum efficiency

$S_{(\text{known load})}$ = KVA rating at known load

$P_{\text{cu}(\text{known load})}$ = Copper loss at known load

For full load

$$S_{\eta_{\max}} = S_{\text{full load}} \cdot \sqrt{\frac{P_i}{P_{\text{cu}(\text{full load})}}}$$

All day efficiency

$$\eta_{\text{all day}} = \frac{\text{Output energy (kWh) in 24 hrs.}}{\text{Input energy (kWh) in 24 hrs.}}$$

Remember:

- The maximum efficiency for a constant load current occurs at unity power factor.
- Efficiency is independent of type of power factor.

Voltage Regulation

Voltage regulation of transformer is defined as the rise in output (secondary) voltage express as the fraction of full load rated voltage when full load (at specified pf) is reduced to zero keeping the primary impressed terminal voltage constant.

$$\text{Voltage regulation} = \frac{\text{No load voltage} - \text{Full load voltage}}{\text{Full load voltage}}$$

where, full load voltage = Rated voltage

Remember:

- Regulation is always calculated on full load and should be as low as possible.

Approximated Equivalent Circuit Referred to Secondary

- Voltage regulation

$$V_1 R = \frac{I_1 R_{1 \text{ eq}}}{V_{\text{rated}}} \cos \phi + \frac{I_1 X_{1 \text{ eq}}}{V_{\text{rated}}} \sin \phi$$

$$V_1 R = R_{\text{p.u.}} \cos \phi + X_{\text{p.u.}} \sin \phi$$

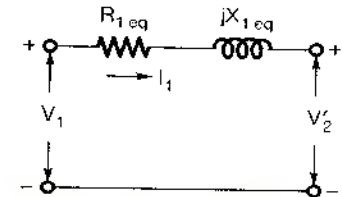

where, ϕ = angle between V_2 and I_1

$R_{\text{p.u.}}$ = p.u. equivalent resistance

$X_{\text{p.u.}}$ = p.u. equivalent reactance

- ϕ is positive for lagging power factor and negative for leading power factor.
- Condition for maximum voltage regulation

$$\cos \phi = \frac{R_{\text{p.u.}}}{Z_{\text{p.u.}}} = \frac{R_{1 \text{ eq}}}{Z_{1 \text{ eq}}} \quad \text{lagging}$$

- Maximum voltage regulation

$$(V_1 R)_{\max} = Z_{\text{p.u.}}$$

- Condition for zero voltage regulation

$$\cos \phi = \frac{X_{\text{p.u.}}}{Z_{\text{p.u.}}} = \frac{X_{1 \text{ eq}}}{Z_{1 \text{ eq}}} \quad \text{Leading}$$

Remember:

- For leading p.f., greater than $\frac{X_{\text{p.u.}}}{Z_{\text{p.u.}}}$, the voltage regulation will be negative
- Regulation is always positive at all lagging p.f. loads and also at unity p.f. load.
- Regulation may be positive at large leading power factor, near to unity and regulation is negative at low leading power factor, away from unity.

Auto Transformer

AB = Series winding

BC = Common winding

N_H = Number of turns in winding AC

N_L = Number of turns in winding BC

- Ratio of transformation

$$a_{\text{auto}} = \frac{V_H}{V_L} = \frac{N_H}{N_L}$$

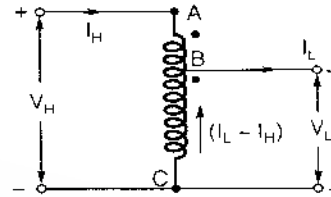

Note:

- Always try to keep a_{auto} closer to 1 i.e. $a \approx 1$ in worst case we try to keep $a_{\text{auto}} = 3 : 1$
- Since there is no electrical isolation between primary winding and secondary winding, so when there is common winding is open circuit then full high voltage is appears across low voltage winding at the time of step down mode.

Comparison Between two Winding Transformer & Auto Transformer

- Copper weight

$$(\text{Cu weight})_{\text{auto}} = \left(1 - \frac{1}{a_{\text{auto}}}\right) \times (\text{Cu weight})_{2\text{-wdg}}$$

- Copper saving

$$\% \text{Copper saving} = \frac{1}{a_{\text{auto}}} \times 100$$

- kVA rating of autotransformer

$$\text{kVA}_{\text{auto}} = \left(\frac{a_{\text{auto}}}{a_{\text{auto}} - 1}\right) \text{kVA}_{2\text{-wdg}}$$

where, kVA_{auto} = kVA rating of auto transformer
 $\text{kVA}_{2\text{-wdg}}$ = kVA rating of two winding-transformer

Inductive and Conductive Transfer

$$V_L I_L = \underbrace{V_L (I_L - I_H)}_{\text{Inductive transfer}} + \underbrace{V_L I_H}_{\text{Conductive transfer}}$$

$$\frac{\text{Inductive transfer}}{\text{total transfer}} = \left(1 - \frac{1}{a_{(\text{auto})}}\right)$$

$$\frac{\text{Conductive transfer}}{\text{Total transfer}} = \left(\frac{1}{a_{(\text{auto})}}\right)$$

Remember:

Auto transformer has higher efficiency, lower p.u. impedance and lower voltage regulation as compare to 2-wdg transformer.

Three Winding Transformer

- Voltage per turn

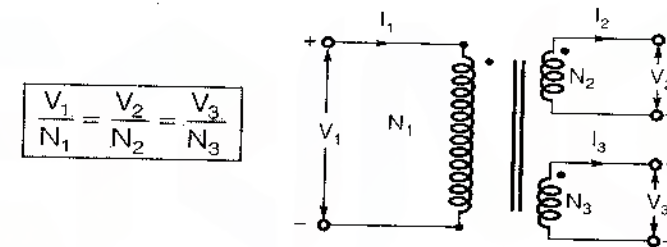

$$\frac{V_1}{N_1} = \frac{V_2}{N_2} = \frac{V_3}{N_3}$$

- MMF balance equation

$$N_1 I_1 = N_2 I_2 + N_3 I_3 \quad (\text{neglect magnetizing current})$$

$$I_1 = \frac{N_2}{N_1} I_2 + \frac{N_3}{N_1} I_3$$

- kVA balance equation

$$V_1 I_1 = V_2 I_2 + V_3 I_3$$

$$S_1 = S_2 + S_3$$

Remember:

- Three winding transformer can be used to interconnect 3 power systems at different voltage levels.
- Tertiary winding is used as a supporting winding in YY transformer to stabilize neutral and to avoid third harmonics.

Application of Different Connection

1. Δ/Δ → This connection is used where we have simple 3 ϕ load, specially at low voltage level. No mix loading possible.
2. Y/Δ → This connection is used for step down application.
3. Δ/Y → This connection is used for step up application except in distribution system where, Δ/Y is used for step down application for mix loading.
4. Y/Y → This connection is quite attractive for HV applications. It is not generally used without a tertiary Δ .

Condition to be Satisfied for Parallel Operation**Must Condition**

- Same polarity.
- Same voltage ratio and voltage rating.
- Same phase sequence.
- Zero phase difference, which means transformer belongs to same phasor group can only operate in parallel.

Desirable Conditions

- Same X/R ratio for same power factor operation.
- Same p.u. impedance on their own kVA base for proportional load sharing.

■ ■ ■ ■

Electromagnetic System**2****□ Magneto motive force**

$$\text{MMF} = \text{Number of turns in the coil} \times \text{current}$$

□ Magnetic flux

$$\phi = \frac{\text{MMF}}{\text{Reluctance}}$$

□ Reluctance

- Opposition offered by the magnetic flux is called Reluctance.

$$R_l = \frac{l}{\mu A}$$

where, R_l = Reluctance

l = Length of magnetic path, meter

A = Area of cross-section normal to flux path, m^2

$\mu = \mu_0 \mu_r$ = Permeability of the magnetic material

μ_r = Relative permeability of the magnetic material

□ Self inductance

- The self-inductance L is defined as the magnetic flux-linkages per ampere

$$L = \frac{\Psi}{I}$$

□ Magnetic flux density

$$B = \frac{\text{Magnetic flux, } \phi}{\text{Cross-section area, } A} \quad \text{Tesla or } \text{Wb/m}^2$$

□ Magnetic field intensity

$$H = \frac{\text{MMF}}{\text{mean length of magnetic circuits}}$$

$$H = \frac{\text{MMF}}{l} \quad \text{AT/m}$$

- Relation between magnetic flux density and field intensity

$$B = \mu H$$

- Energy density in electric field

$$w_{fld} = \int_0^D E \cdot dD = \frac{1}{2} \frac{D^2}{\epsilon_0}$$

where, D = Electric field flux density
E = Electric field intensity or potential gradient

$$E = \frac{D}{\epsilon_0}$$

Reluctance Motor

- Reluctance at space angle θ_r ,

$$Rl = Rl_q \sin^2 \theta_r + Rl_d \cos^2 \theta_r$$

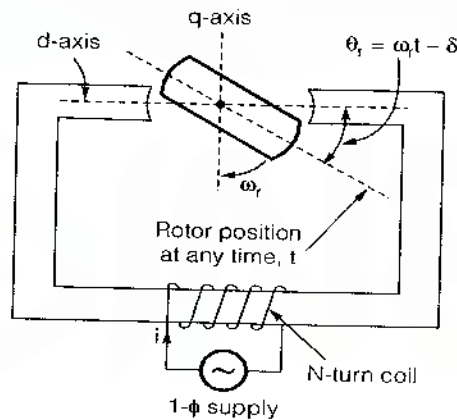

where, Rl_q = quadrature-axis reluctance
 Rl_d = direct-axis reluctance
 θ_r = space angle between stator d-axis and long rotor axis

- Torque

$$T_e = -\frac{1}{2} \phi^2 \frac{dRl}{d\theta_r}$$

$$T_e = -\frac{1}{2} \phi^2 (Rl_q - Rl_d) \sin 2\theta_r$$

- Space angle

$$\theta_r = \omega_r t - \delta$$

where, δ = rotor position from stator d-axis at $t = 0$ or load angle

- Direct-axis inductance

$$L_d = \frac{N^2}{Rl_d}$$

- Quadrature-axis inductance

$$L_q = \frac{N^2}{Rl_q}$$

- Average torque

$$T_{e(av)} = \frac{1}{8} \phi_{max}^2 (Rl_q - Rl_d) \sin 2\delta$$

$$T_{e(av)} = \frac{V^2}{4\omega} \left(\frac{1}{X_q} - \frac{1}{X_d} \right) \sin 2\delta$$

$$T_{e(av)} = \frac{V^2}{4\omega} (I_d - I_q) \sin 2\delta$$

where, I_d, I_q = Current taken from the supply when the rotor is held in minimum and maximum reluctance position.



Basic Concepts in Rotating Electrical Machines

3

Introduction

□ Electromagnetic torque

- Also called interaction torque.

$$T_e \propto (\text{Stator field strength}) (\text{Rotor field strength}) \sin \delta$$

where, δ = Torque angle

□ Electrical and Mechanical degrees

$$\theta_{\text{elec}} = \frac{P}{2} \theta_{\text{mech}}$$

where, θ_{elec} = angle in electrical degree

θ_{mech} = angle in mechanical degree

P = number of poles

□ Pole pitch

The peripheral distance between adjacent poles is called pole pitch. It is always equal to 180 electrical degree.

□ Average value of flux density wave over one pole-pitch

$$B_{\text{av}} = \frac{2}{\pi} B_p$$

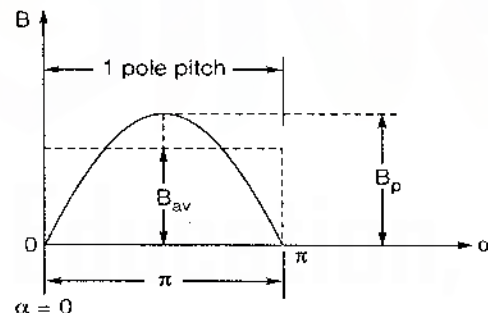

where, B_p = Maximum flux density

□ Total flux per pole

$$\phi = \frac{4}{P} B_p r l$$

where, l = Axial length of the armature core
 r = Radius of armature core

□ Generated emf in a full-pitched coil

$$e = N \omega_r \phi \sin \omega_r t$$

where, N = Number of turns in single full pitched coil

ϕ = flux per pole

ω_r = relative velocity between field flux wave and armature coil

□ Rms value of generated emf in a full-pitched coil

$$E = 4.44 f_r N \phi$$

where, f_r = rotational or speed frequency

□ Rotational frequency

$$f_r = \frac{P n_r}{2} \text{ Hz}$$

where, n_r = relative speed between armature coil and flux-density wave in rps.

□ Generated emf in a short-pitched coil

$$E = 4.44 k_p f_r N \phi$$

where, k_p = coil pitch factor or coil-span factor or pitch factor

□ Pitch factor

$$k_p = \cos \frac{\epsilon}{2}$$

where, ϵ = Angle of chording (or pitching) for fundamental flux wave.

Note:

For n^{th} space field harmonic, chording angle becomes $n \epsilon^\circ$ electrical.

$$k_{pn} = \cos \frac{n \epsilon}{2}$$

□ Distribution factor

$$k_{d1} = \frac{\sin \left(\frac{m \gamma}{2} \right)}{m \sin \left(\frac{\gamma}{2} \right)}$$

where, q = No. of slots per pole per phase
 γ = Angular slot pitch

$$\gamma = \frac{180 P}{\text{Total no. of slots}} \text{ electrical degree}$$

□ Distribution factor for n^{th} harmonic

$$k_{dn} = \frac{\sin\left(\frac{qn\gamma}{2}\right)}{q \sin\left(\frac{n\gamma}{2}\right)}$$

□ Winding factor

$$k_w = k_p \times k_d$$

□ Phase spread

$$\sigma = q\gamma \text{ ... in electrical space degrees}$$

□ Synchronous speed

Speed at which rotating magnetic field revolves is called synchronous speed

$$n_s = \frac{120f}{p} \text{ r.p.m.}$$



D.C. Machines

D.C. machine is a flexible and highly versatile energy conversion machine. It can easily supply the demand of loads requiring high starting torque, high accelerating and high decelerating torques. D.C. machine is also suitable for drives requiring wide range of speed control.

Classification of D.C. Machines

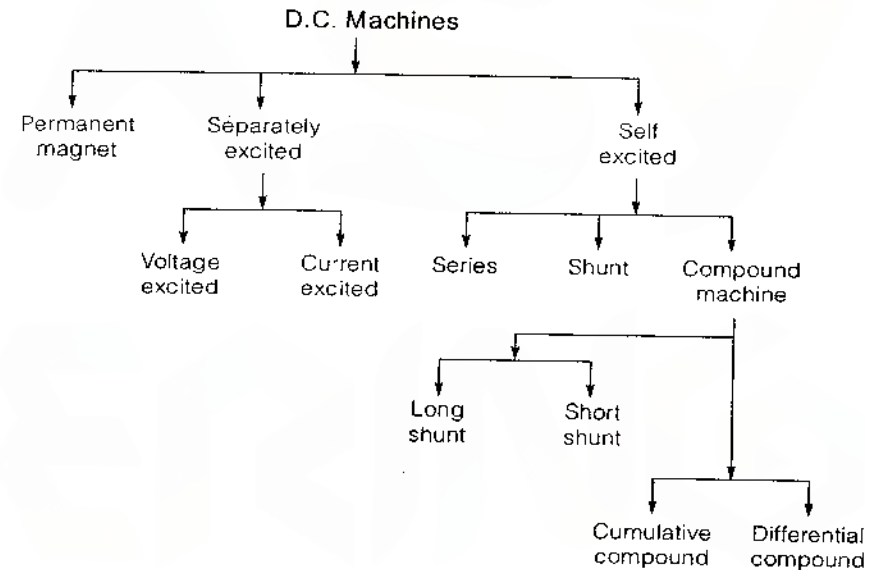

- **Separately excited:** Field winding is energized by an external D.C. source.
- **Self excited:** Field winding is excited by its own armature.

Remember:

- Series field winding is thick, has small number of turns and carry large current.
- Shunt field winding is thin, has large number of turns and carry less current.

□ E.m.f generated in the armature

$$E_a = \frac{\phi Z N}{60} \times \left(\frac{P}{A}\right) = k \phi \omega_m$$

- where, ϕ = Flux per pole, wb
 P = Number of poles
 Z = No. of conductor
 A = No. of parallel paths = P for lap winding
 = 2 for wave winding
 N = Speed in rpm
 $\omega_m = \frac{2\pi N}{60}$ = Mech. angular velocity (mech. rad per sec.)
 $k = \frac{PZ}{2\pi A}$ = Constant of the machine

□ Torque equation

$$T = k \phi I_a = \frac{1}{\omega_m} E_a I_a$$

where, T = Torque developed, in N-m
 I_a = Armature current

Circuit Model

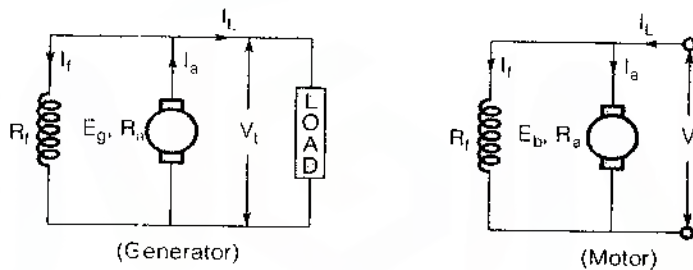

$$V_t = E_g - I_a R_a \quad \dots \text{For generator}$$

$$V = E_b + I_a R_a \quad \dots \text{For motor}$$

- where, V_t = Terminal voltage
 V = supply voltage to motor
 E_g = Generated Emf
 E_b = Back Emf
 R_a = Armature resistance
 R_f = Field resistance
 I_a = Armature current

- I_f = Field current
 I_L = Load current
 E_g = E_b = E_a = Voltage developed in armature

Note:

Generated emf in generator is called back emf in motor.

Power Balance in D.C. Machine

(a) Generator Action

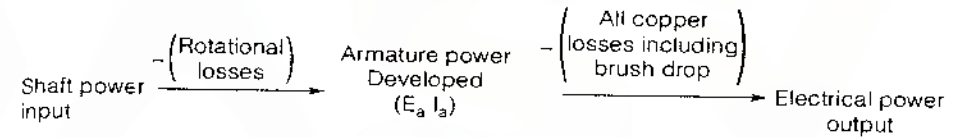

(b) Motor Action

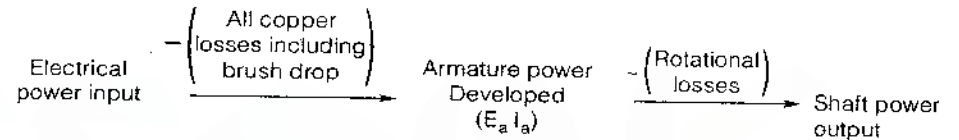

□ Armature power developed

$$P_a = E_a I_a$$

Efficiency

$$\eta = 1 - \frac{\text{Losses}}{\text{Input power}} = \frac{\text{Output power}}{\text{Input power}} = \frac{\text{Output power}}{\text{Output power} + \text{Losses}}$$

1. DC generator

$$\eta_g = \frac{\text{Output power}}{\text{Output power} + \text{losses}}$$

$$\eta_g = \frac{V_t I_L}{V_t I_L + (I_f^2 R + V_{BD} I + P_K)}$$

where, $V_L I_L =$ Output power
 $I^2 R =$ Total ohmic losses
 $P_K =$ Constant losses
 $V_{BD} I =$ Brush contact losses
 $V_L =$ Output voltage
 $I_L =$ Load current

2. DC motor

$$\eta_m = \frac{\text{Input power} - \text{Losses}}{\text{input power}}$$

$$\eta_m = \frac{VI - (I^2 R + V_{BD} I + P_K)}{VI}$$

where, $VI =$ Input electrical power

Note:

- For generator and motor maximum efficiency occurs when
 constant loss = variable loss

i.e.

$$P_k = I^2 R \text{ (ohmic loss)}$$

- Maximum power output by DC motor when

$$E_a = \frac{V}{2} \quad \text{and} \quad I_a = \frac{V}{2R_a}$$

- When motor operates at maximum power output, it gives only 50% efficiency.

Characteristics of D.C. Generator

1. No load (or) magnetisation characteristic (or) open circuit characteristics (O.C.C.)

Magnetisation characteristic gives the variation of generated voltage (or) no load voltage with field current at a constant speed.

2. Internal characteristics

It is plot between the generated voltage and load current.

3. Load or external characteristics

Between terminal voltage V_s load current (I_L) at a constant speed.

(a) Open circuit characteristics (OCC) (no load) for all types of generator

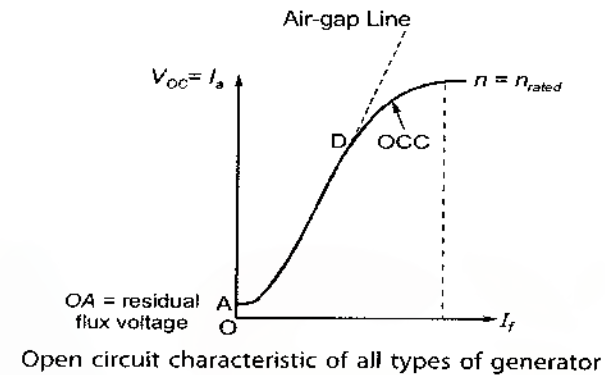

Note:

OCC does not start from origin due to the presence of residual magnetism.

(b) Characteristics for separately excited generator

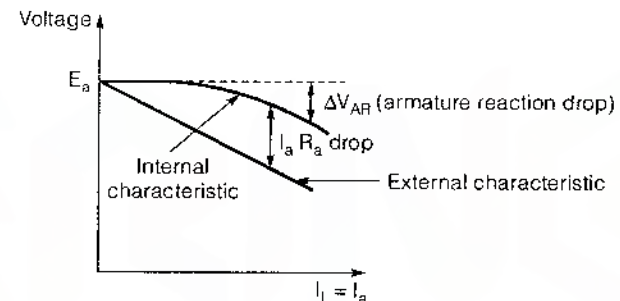

Characteristics of separately excited DC generator

(c) Characteristics for shunt generator

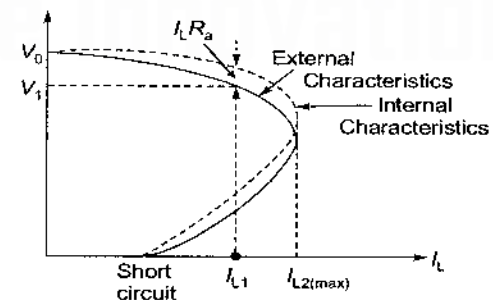

External Characteristics of DC shunt Generator

(d) Characteristics for series generator

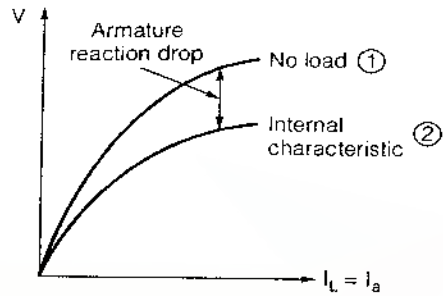

Characteristics of DC series generator

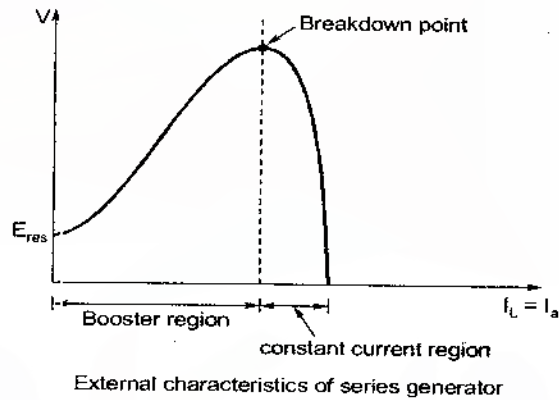

Note:

- Constant current region is suitable for welding.
- Series generator is used in booster region for line drop compensation.

(e) Characteristics for compound generator

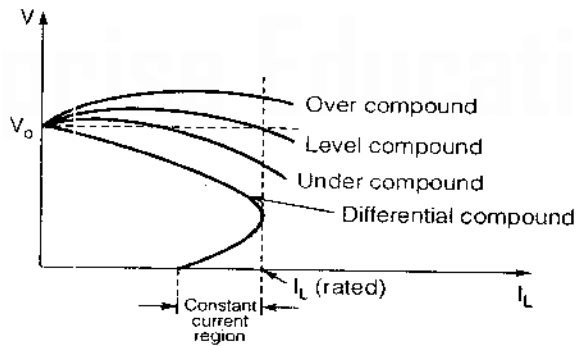

External characteristics of a compound generator

Characteristics of D.C. Motor

1. Speed Vs armature current (N Vs I_a).
2. Torque Vs armature current (T Vs I_a).
3. Speed Vs torque (N Vs T).

(a) Characteristics for DC shunt motor

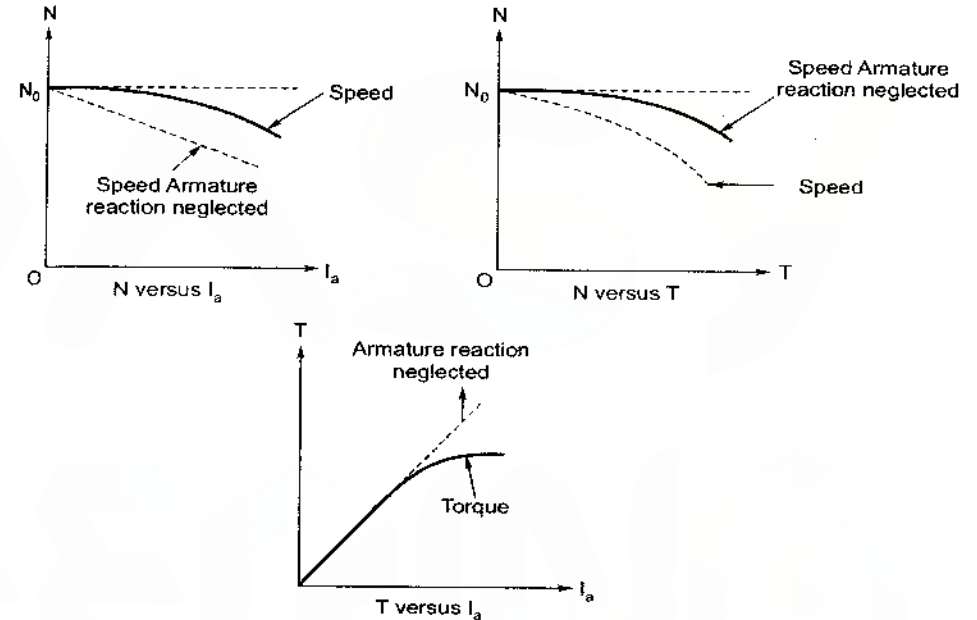

(b) Characteristics for DC series motor

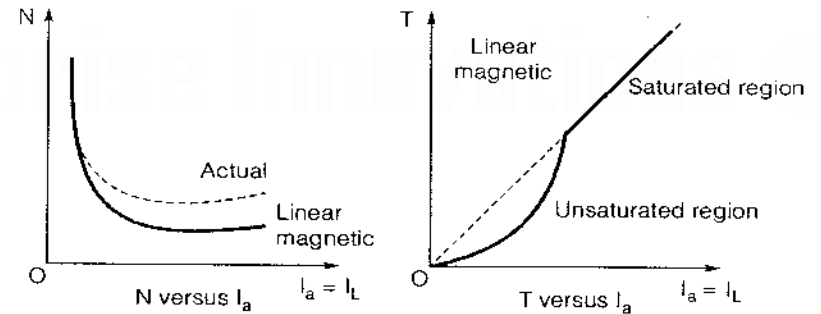

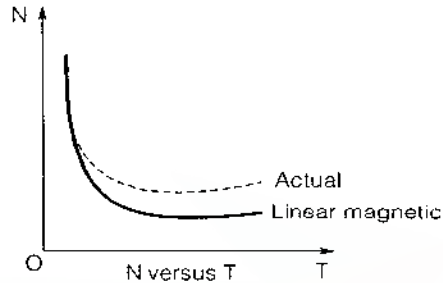
**Note:**

In a traction system, we use series motor where high starting torque is required.

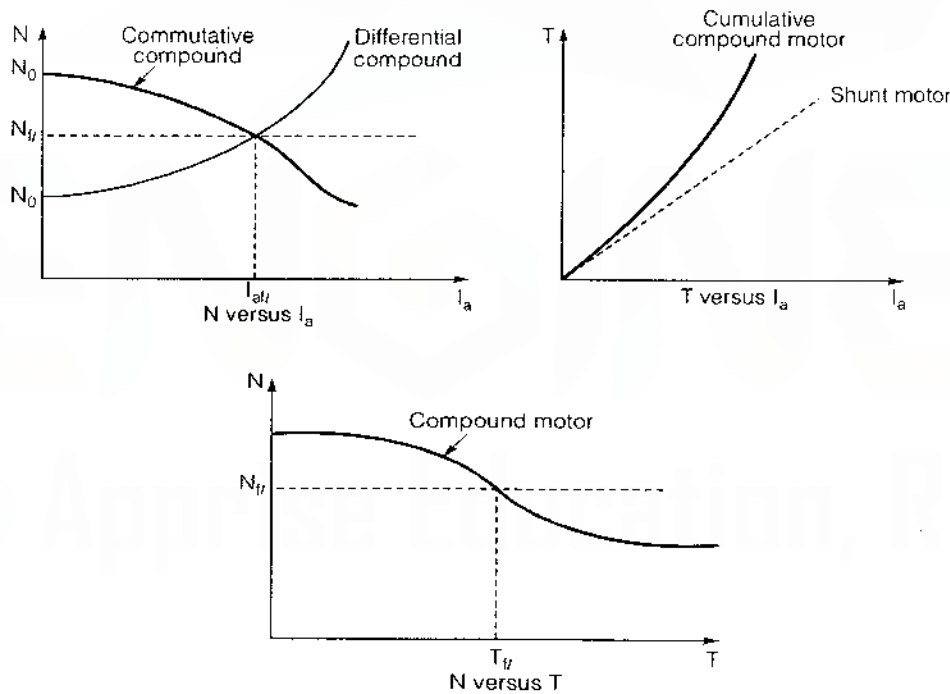
(c) Characteristics of DC compound motor**Note:**

- Magnetic flux has a tendency to follow a minimum reluctance path.
- Exciting or field windings produces the working flux or main flux.
- In Armature winding, the working emf is induced by working flux.
- For the development of electromagnetic torque in all rotating machine, the number of rotor poles should be equal to the number of stator poles.

Voltage Build up fails in generator if

- Residual flux absent.
- Field connection is wrong, reverse I_f destroys ϕ_{Res} .
- Direction of rotation is wrong.
- Field resistance is more than critical field resistance.
- Speed less than critical speed.

Remember:

- In D.C. machine, the field winding is on the stator and the armature winding is on rotor.
- Commutator serve as:
For D.C. generator: Mechanical rectifier.
For D.C. motor: Mechanical inverter.
- D.C. series motor never runs at no load.

Armature Reaction

- The effect of armature flux on the main field flux distribution in the air gap is called armature reaction.
- The armature mmf produces two undesirable effects on the main flux.
 1. Net reduction in the main field.
 2. Distortion of the main field flux wave along the air gap periphery.
- The effect of armature flux on the main field is cross-magnetizing as well as demagnetizing.
- Flux created by the armature mmf is called cross-flux

$$\bar{\Phi}_R = \bar{\Phi}_a + \bar{\Phi}_f$$

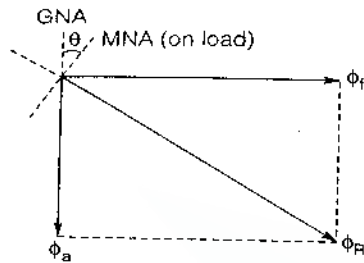

where, ϕ_f = Flux produced by field mmf
 ϕ_a = Flux produced by armature mmf
 ϕ_r = Resultant flux

Remember:

- Magnetic neutral axis (MNA) is always perpendicular to the axis of resultant field flux.
- Geometric neutral axis (GNA) is along the quadrature axis of the d.c. machine.

Effect of brush shift

MNA shift in the direction of rotation for a generator and against the direction of rotation for a motor to ensure good commutation.

Demagnetizing ampere turns

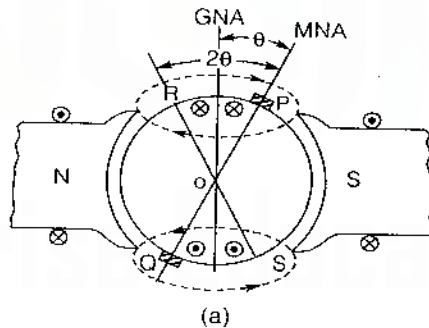

Demagnetizing armature mmf per pole.

$$F_{ar(\text{demag})} \text{ per pole} = \frac{(Z/2)}{P} \times \left(\frac{2\theta_{\text{etc}}}{180^\circ} \right) \times \frac{I_a}{A}$$

Cross-magnetizing ampere turns

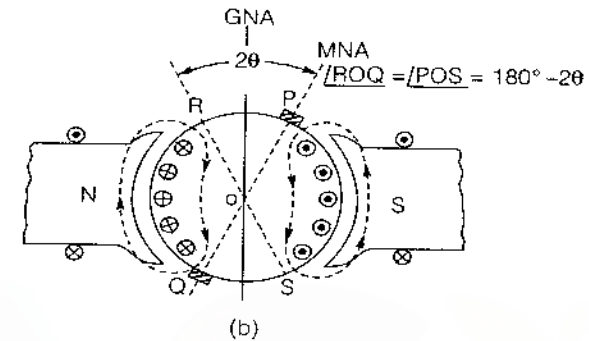

Cross magnetizing armature mmf per pole.

$$F_{ar(\text{cross})} \text{ per pole} = \frac{(Z/2)}{P} \times \left(1 - \frac{2\theta_{\text{etc}}}{180^\circ} \right) \times \frac{I_a}{A}$$

Compensating winding mmf per pole (AT_c).

$$AT_c = \frac{(Z/2)}{P} \times \frac{\text{Pole arc}}{\text{Pole pitch}} \times \frac{I_a}{A}$$

Note:

- Compensating winding mmf neutralizes the armature mmf only under the main pole face.
- Interpoles are used to neutralise the armature reaction flux in the interpolar axis. It also produces some rotational voltage in the coil undergoing commutation and neutralizes the reactance voltage and improves the commutation.
- Polarity of interpoles is same as the succeeding main pole in generator action and of the preceding main pole in motor action.
- The interpole winding and compensating winding carry armature current.
- Interpoles are long but narrow in shape to avoid saturation.

Speed Control of D.C. Machine

$$N = \frac{V - I_a R_a}{k\phi}$$

Speed can be controlled by

- **Armature voltage control:**
 - (i) Constant torque drive.
 - (ii) Speed control is possible only below base speed i.e. $N < N_B$.
- **Armature resistance control:**
 - (i) Constant torque drive.
 - (ii) Speed control is possible only below base speed i.e. $N < N_B$.
 - (iii) Wide range of speed control is not possible.
- **Field flux control:**
 - (i) It is constant power drive.
 - (ii) Speed control is possible above base speed i.e. $N > N_B$.

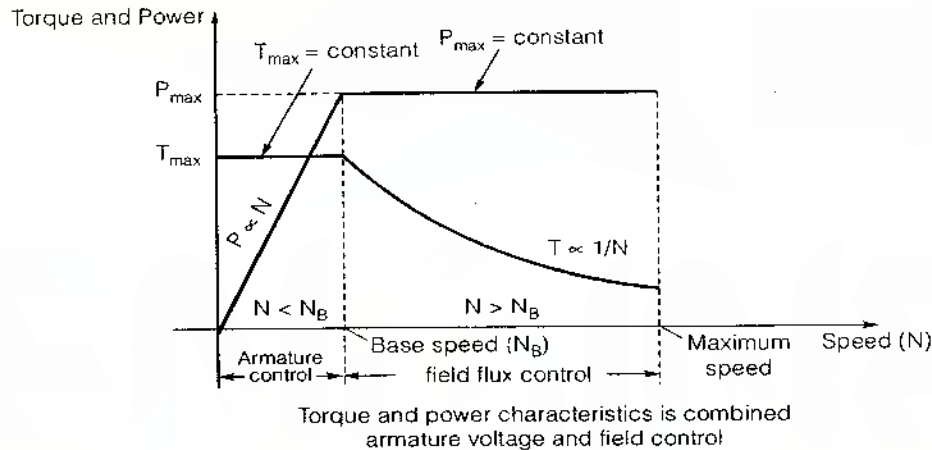

Polyphase Induction Motors

5

Introduction

Induction Motor is singly-excited a.c. machine. Its stator winding is directly connected to a.c. source, whereas its rotor winding receives its energy from stator by means of induction.

Types of Induction Motor Rotors

1. Squirrel - Cage rotor

- Consist of a cylindrical laminated core with slots nearly parallel to the shaft axis or skewed.
- Each slot contains an un-insulated bar conductor of aluminum or copper.
- At each end of the rotor, rotor bar conductors are short circuited by heavy end rings of the same material.

2. Wound rotor or Slip-ring rotor

- Consists of slotted armature.
- Insulated conductors are put in the slots and connected to form a three-phase double layer distributed winding similar to stator winding.
- The open ends of the star circuit are brought outside the rotor and connected to three insulated slip rings.

Remember:

Cage rotor is cheaper, require lesser maintenance and have higher efficiency and higher power factor than wound rotors.

.....

Production of Rotating Magnetic Field in 3 ϕ System

- If a 3 ϕ balance winding is excited by 3 ϕ balance current, a resultant mmf or flux is produced of constant magnitude of $\frac{3}{2}F_m$ or $\frac{3}{2}\phi_m$ in air gap of motor and rotate in space at synchronous speed (N_s).
- The direction of rotation of resultant flux in the air gap depends upon the phase sequence.

Remember:

- Resultant mmf can be given as

$$F_R = \frac{3}{2} F_m \cos(\omega t - \theta)$$

where, F_R = resultant mmf
 F_m = maximum mmf

Speed and Slip**Synchronous speed (N_s)**

$$N_s = \frac{120f}{P}$$

where, f = Supply frequency
 P = Number of poles

Slip (s)

$$s = \frac{N_s - N_r}{N_s}$$

where, N_s = Synchronous speed, rpm
 N_r = Rotor speed, rpm

Rotor frequency

$$f_2 = s f_1$$

where, f_1 = Line frequency

Note:

- Speed of stator field w.r.t. stator = N_s .
- Speed of rotor field w.r.t. stator = N_s .
- Speed of rotor w.r.t. stator = N_r .
- Speed of stator field w.r.t. rotor = $(N_s - N_r)$.
- Speed of rotor field w.r.t. rotor = sN_s .
- Relative speed between rotor field and stator field is zero.
- Rotor speed $N_r = (1 - s)N_s$.
- Rotor of induction motor never runs at synchronous speed ($N_r < N_s$) otherwise induced emf in rotor = 0.

Per phase induced emf**in stator winding**

$$E_1 = \sqrt{2} \pi N_1 f_1 \phi k_{w1}$$

in rotor winding

$$E_2 = \sqrt{2} \pi N_2 f_1 \phi k_{w2}$$

At any slip 's'

$$E_2 = \sqrt{2} \pi N_2 (s f_1) \phi k_{w2}$$

where, k_{w1}, k_{w2} = Winding factors of stator and rotor windings respectively

N_1, N_2 = Number of turns of stator and rotor winding respectively

Rotor Emf current and power

- Per phase rotor current at any slip 's'

$$I_2 = \frac{E_2}{\sqrt{\left(\frac{r_2}{s}\right)^2 + X_2^2}}$$

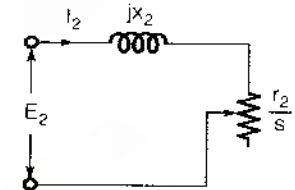

where, r_2 = Rotor resistance at standstill

X_2 = Rotor leakage reactance at standstill

E_2 = Per phase value of induced Emf at standstill

- Rotor power factor

- Rotor current I_2 lags the rotor voltage E_2 by an angle θ_2 .

$$\theta_2 = \tan^{-1} \left(\frac{sX_2}{r_2} \right)$$

- Rotor power factor = $\cos \theta_2$

- Per phase power input to rotor

$$P_g = E_2 I_2 \cos \theta_2 = I_2^2 \frac{r_2}{s}$$

P_g is the power transferred from stator to rotor across the air gap also called air-gap power.

- Rotor ohmic loss = $I_2^2 r_2 = sP_g$
- Internal mechanical power developed in rotor

$$P_m = (1-s)P_g$$

- Internal (or gross) torque developed per phase

$$T_e = \frac{\text{Internal mechanical power developed in rotor}}{\text{Rotor speed in mechanical rad. per sec.}}$$

$$T_e = \frac{P_g}{\omega_s} = \frac{P_m}{\omega_r} = \frac{\text{Rotor ohmic loss}}{\omega_s \times \text{slip}}$$

where, ω_s, ω_r = Synchronous speed and rotor speed in mechanical rad. per sec.

- Output or shaft power

$$P_{sh} = P_m - \text{Mechanical losses}$$

$$P_{sh} = P_g - \text{Rotor ohmic losses} - \text{Mechanical losses}$$

Note:

Friction and windage losses are the mechanical losses.

- Output or shaft torque

$$T_{sh} = \frac{P_{sh}}{\text{rotor speed}} = \frac{P_{sh}}{(1-s)\omega_s}$$

- Air gap power

$$P_g = \text{Stator power input} - \text{Stator } I^2R \text{ loss} - \text{Stator core loss}$$

Power Flow Diagram

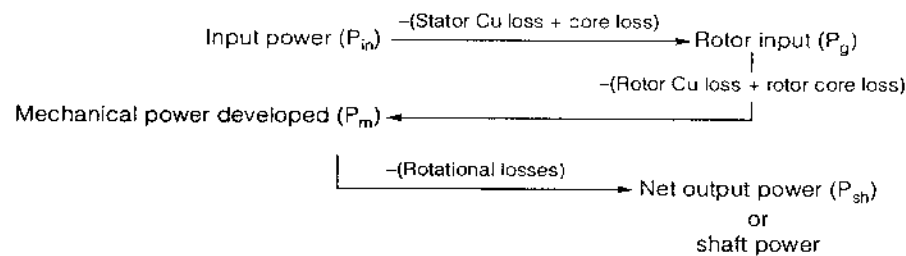

Efficiency

Efficiency of a 3-phase induction motor (η)

$$\eta = \frac{P_{sh}}{P_{sh} + P_f + P_{oh}} \times 100$$

where, P_{sh} = Shaft power

P_f = Fixed losses = core loss + friction and windage losses

P_{oh} = Stator and rotor ohmic losses

Equivalent Circuit

Exact equivalent circuit referred to stator

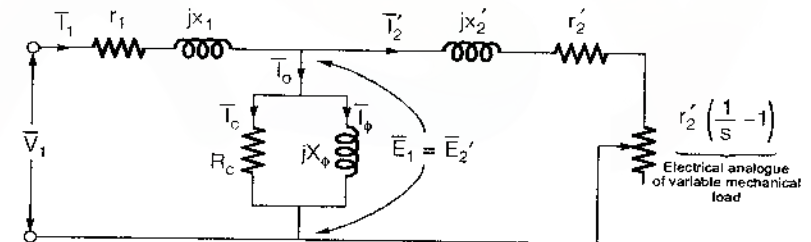

- Transformation ratio

$$a = \frac{E_1}{E_2} = \frac{\left(\begin{array}{l} \text{Effective number of stator-series turns} \\ \text{per phase } (N_1) \end{array} \right)}{\left(\begin{array}{l} \text{Effective number of rotor-series turns} \\ \text{per phase } (N_2) \end{array} \right)}$$

- Per phase generated Emf in rotor circuit referred to stator side

$$E_2' = aE_2$$

- Per phase rotor current referred to stator side

$$I_2' = \frac{I_2}{a}$$

- Per phase rotor resistance referred to stator side

$$r_2' = a^2 r_2$$

- Per phase rotor leakage reactance referred to stator side

$$x_2' = a^2 x_2$$

where, r_1, r_2 = Per phase stator and rotor resistances.

x_1, x_2 = Per phase stator and rotor leakage reactances at standstill.

Analysis of the equivalent circuit

All the rotor quantities have been referred to stator side.

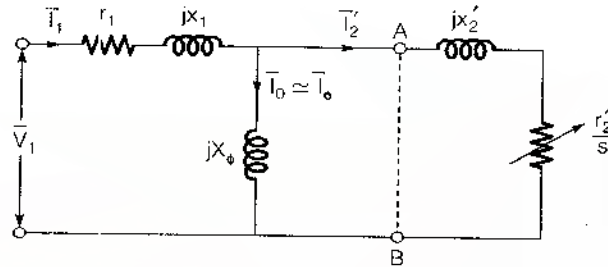

Thevenin equivalent circuit

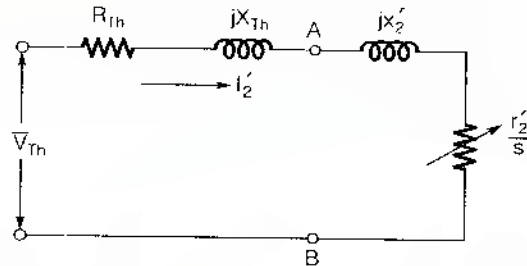

□ Thevenin voltage across points A and B

$$V_{Th} = \frac{V_1}{r_1 + j(x_1 + X_\phi)} \cdot jX_\phi$$

□ Thevenin equivalent impedance across points A and B

$$Z_{Th} = \frac{(r_1 + jx_1) \times jX_\phi}{r_1 + j(x_1 + X_\phi)} = R_{Th} + jX_{Th}$$

□ Thevenin equivalent resistance and reactance across points A and B Neglecting r_1 as $r_1 \ll (x_1 + X_\phi)$

$$R_{Th} = \frac{r_1 X_\phi}{X} \quad \text{and} \quad X_{Th} = \frac{x_1 X_\phi}{X}$$

where, X_ϕ = Magnetizing reactance

V_1 = Stator applied voltage; $X = x_1 + X_\phi$

□ Total torque

$$T_e = \frac{K_t}{\left(R_{Th} + \frac{r_2'}{s}\right)^2 + X_1^2} \cdot \frac{r_2'}{s}, \text{ N-m}$$

where, $K_t = \frac{3V_{Th}^2}{\omega_s}$ and $X_1 = x_2' + X_{Th}$

□ Maximum internal torque

$$T_{em} = \frac{K_t}{2 \left[R_{Th} + \sqrt{R_{Th}^2 + X_1^2} \right]}, \text{ N-m}$$

Note:

Maximum internal torque is also referred as stalling torque, pull-out torque or breakdown torque.

□ Slip at maximum torque

$$s_{mT} = \frac{r_2'}{\sqrt{R_{Th}^2 + X_1^2}}$$

□ Starting torque

$$T_{e,st} = \frac{K_t}{(R_{Th} + r_2')^2 + X_1^2} \cdot r_2'$$

□ Motor torque in terms of maximum torque

$$T_e = \frac{2 T_{em}}{\frac{s_{mT}}{s} + \frac{s}{s_{mT}}}$$

□ Total mechanical power developed

$$P_m = \frac{3V_{Th}^2}{\left[R_{Th} + r_2' + \frac{r_2'(1-s)}{s} \right]^2 + X_1^2} \cdot r_2' \left(\frac{1-s}{s} \right)$$

□ Slip at maximum power

$$s_{mP} = \frac{r_2'}{\sqrt{(R_{Th} + r_2')^2 + X_1^2 + r_2'^2}}$$

Maximum power

$$P_{m,max.} = \frac{3V_{Th}^2}{2 \left[R_{Th} + r_2' + \sqrt{(R_{Th} + r_2')^2 + X_1^2} \right]}$$

Remember:

- $P_{m,max.}$ depends on rotor resistance r_2' whereas T_{em} does not.
- At starting, internal mechanical power developed is zero.

In order to get maximum power output from induction generator. The rotor speed (n_r)

$$n_r = n_s \left[1 + \frac{r_2'}{\sqrt{(R_{Th} + r_2')^2 + X_1^2 + r_2'}} \right]$$

$$\left(\frac{I_{2,st}}{I_2} \right)^2 = \frac{1 + \left(\frac{S_{mT}}{s} \right)^2}{1 + S_{mT}^2}$$

$$\left(\frac{I_{2,mT}}{I_2} \right)^2 = \frac{1}{2} \left[1 + \left(\frac{S_{mT}}{s} \right)^2 \right]$$

where, $I_{2,st}$ = Stator load component of current at starting
 $I_{2,mT}$ = Stator load component of current at maximum torque

Approximate Analysis

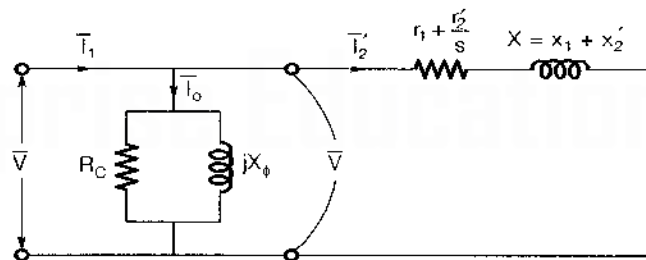

$$I_2 = \frac{V}{\sqrt{\left(r_1 + \frac{r_2'}{s} \right)^2 + X^2}}$$

$$T = \frac{3}{\omega_s} \frac{V^2 r_2' / s}{\left(r_1 + \frac{r_2'}{s} \right)^2 + X^2}$$

Starting torque

$$T_{st} = \frac{3}{\omega_s} \frac{V^2 r_2'}{\left(r_1 + r_2' \right)^2 + X^2}$$

Maximum torque

$$T_{mT} = \frac{3}{\omega_s} \left(\frac{V^2}{2X_2'} \right)$$

Slip at max. torque

$$s_m = \frac{r_2'}{X_2'} = \frac{r_2}{X_2}$$

Remember:

- At high slip (i.e. $s \approx 1$)

$$T \propto \frac{1}{s}$$

- At low slip (i.e. $s \approx 0$)

$$T \propto s$$

Torque Slip Characteristics

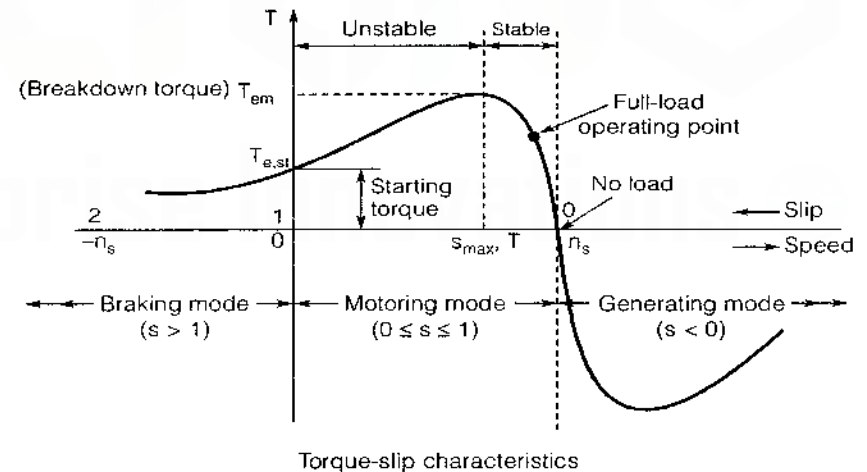

Remember:

- $T_m \propto \frac{1}{f^2}$
- $T_{st} \propto \frac{1}{f^3}$
- Efficiency of I.M., $\eta \propto \frac{1-s}{1+s}$

where, f = frequency
 s = slip

Determination of equivalent circuit parameters**1. No Load Test (O.C. Test):**

Test performed at rated voltage to determine

- Iron loss at rated voltage i.e. P_i .
- Shunt branch parameter i.e. R_C and X_ϕ .

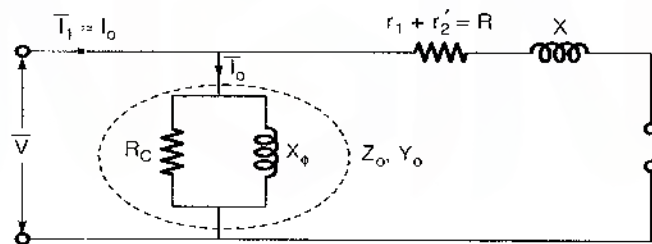

where, I_0 = No load current
 V = Rated voltage applied to stator
 P_i = Fixed losses read by watt meter

$$R_C = \frac{V^2}{P_i}$$

$$G_C = \frac{1}{R_C}$$

$$Z_o = R_C \parallel jX_\phi$$

$$Y_o = \frac{1}{Z_o} = G_C - jB_\phi$$

$$Y_o = \frac{I_o}{V}$$

$$B_\phi = \sqrt{Y_o^2 - G_C^2}$$

$$X_\phi = \frac{1}{B_\phi}$$

2. Block Rotor Test

- Supply is given but the rotor is blocked to rotate mechanically.
- This test is also called short circuit test to determine copper loss at rated current. This test is performed at rated current condition.

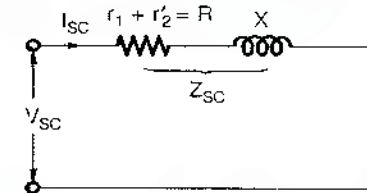

where,

I_{sc} = Rated current

V_{sc} = Voltage that is required to circulate I_{sc} when rotor is blocked

P_{sc} = Total copper loss on full load at standstill, read by wattmeter

$$R = \frac{P_{sc}}{I_{sc}^2}$$

$$Z_{sc} = \frac{V_{sc}}{I_{sc}}$$

$$X = \sqrt{Z_{sc}^2 - R^2}$$

Note:

In block rotor condition, reduced voltage (up to 5% of rated) is required to flow the rated current.

Starting Method of 3 ϕ Induction Motor

1. Direct Online Starting (D.O.L.)

To reduce the starting current if voltage is reduce by a fraction x , the starting current is also reduce by a fraction x but the starting torque gets reduce significantly by a factor x^2 .

2. Auto Transformer Starting

Both starting current from supply and torque are reduced by same factor x^2 .

Remember:

If $x = 1/\sqrt{3}$ results are same as Y- Δ starting.

3. Start-Delta Starting

In this, Δ connected induction motor started as Y connected, and as motor picks up the speed the connection are changed to Δ i.e. it runs as Δ connected.

If delta connected I.M. is started as star connected both the starting current and torque are reduce by a factor of $1/3$.

Remember:

By increasing rotor resistance, starting torque increases but maximum torque remains unchanged.

Speed Control of Induction Motor

Rotor speed of induction motor is

$$N_r = N_s(1 - s)$$

The rotor speed can be controlled by

- (i) slip control technique and
- (ii) synchronous speed control technique.

1. Slip Control Technique

$$T = \frac{sV^2}{R} \quad \text{where } T \text{ remains constant.}$$

- (a) Voltage control technique: Applicable for both I.M. i.e. slip ring induction motor (SRIM) and squirrel cage I.M.
- (b) Rotor resistance method: Only in SRIM.
- (c) Rotor emf injection method: Only in SRIM.

2. Synchronous Speed Control Technique

$$N_s = \frac{120f}{P} \quad \text{and} \quad N_r = N_s(1 - s)$$

- (a) Frequency control technique: Applicable in both induction motor.
- (b) Pole changing technique: Only in squirrel cage I.M.
- (c) Cascading of 2 induction motor: In this method one I.M. must be SRIM. while, other can either squirrel cage or SRIM.

Cogging

Number of Slot in stator = S_1

Number of slot in rotor = S_2

If either $S_1 = S_2$ or integral multiple to each other then the stator teeth and rotor teeth which are actually parallel, may develop very strong alignment force at the time of start and therefore the induction motor may fail to start, with rotor teeth blocked against the stator teeth. This phenomenon is known as cogging.

Crawling

The airgap flux in a 3 ϕ induction motor contains harmonics of the order of $(6n \pm 1)$, then create parasitic torque. Due to these harmonic, motor continue to rotate stably at a speed N much less than full load speed N_{fl} . This phenomenon is called crawling.

Remember:

- Cogging and crawling phenomenon are usually not encountered in S.R.I.M. as their starting torque is high enough to accelerate it.
- Power factor: Wide bar rotor < deep bar rotor < semi open slot < closed slot.
- Leakage flux: Closed slot > semi closed slot > deep bar > wide bar.



A three-phase synchronous machine is a doubly excited ac machine because its field winding is energized from a dc source and its armature winding connected to an ac source. It rotates with speed of revolving field i.e. synchronous speed.

Remember:

- In synchronous machine, windings are always connected in star.
- Armature winding is placed in stator and field winding is in rotor.

□ Synchronous speed

$$N_s = \frac{120f}{P} \text{ rpm}$$

where, f = Frequency of armature current
 P = Number of field poles

□ RMS induced emf per phase

$$E_a = 4.44 f N_e \Phi_p$$

where, N_e = Effective turns per phase
 Φ_p = Total flux linking a full-pitch coil

□ Effective number of turns

$$N_e = N_c k_p k_d$$

where, N_c = Coil turns
 k_d = Distribution factor
 k_p = Pitch factor

□ Winding factor

$$k_w = k_p k_d$$

Types of Rotor

(a) Salient Pole Rotor

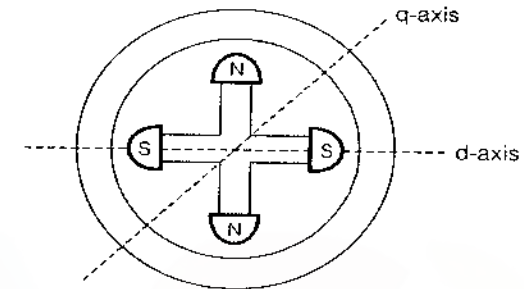

- Salient pole windings are concentrated winding and connected in series.
- d-axis and q-axis are 90° electrical to each other.
- Air gap is minimum along d-axis and maximum along q-axis.
- Salient pole machine drives at low speed and hence is called as low speed alternator or hydro alternator.
- Salient pole rotor has large diameter and small axial length.

Remember:

Salient pole alternator also called as hydro alternator.

(b) Cylindrical Rotor

- Field winding is distributed and all coils are connected in series.
- Air gap is uniform.
- It can be driven at high speed so it is also known as high speed alternator or turbo generator.
- Cylindrical rotor has smaller diameter and larger axial length.

Note:

- In alternator, main field mmf leads the air-gap mmf and air-gap mmf leads the armature mmf. Therefore, in alternator main field mmf is most leading.
- In motor, main field mmf lags the air-gap mmf and air-gap mmf lags the armature mmf. Therefore, in motor main field mmf is most lagging.
- For unidirection torque production, number of rotor poles must be equal to number of stator poles and they must be stationary with respect to each other.

Armature Reaction

The effect of armature flux (ϕ_a) on main field flux (ϕ_m) is known as armature reaction. Armature reaction depends upon the magnitude of load and load power factor.

P.F.	Alternator	Motor
1. Unity	Purely cross magnetizing	Purely cross magnetizing
2. ZPF lag	Purely demagnetizing	Purely magnetizing
3. ZPF lead	Purely magnetizing	Purely demagnetizing
4. 0.8 lag	Partly demagnetizing + Partly cross magnetizing	Partly magnetizing + Partly cross magnetizing
5. 0.8 lead	Partly magnetizing + Partly cross magnetizing	Partly demagnetizing + Partly cross magnetizing

Synchronous Generator Model:

$$\bar{E}_f = \bar{V}_a + \bar{I}_a R_a - \bar{E}_l - \bar{E}_{ar}$$

$$\bar{E}_f = \bar{V}_a + \bar{I}_a R_a + j\bar{I}_a X_l + j\bar{I}_a X_a$$

- where,
- \bar{E}_f = Excitation voltage or internal voltage
 - \bar{E}_{ar} = Armature reaction voltage
 - \bar{E}_l = Armature leakage flux voltage
 - R_a = Armature resistance
 - X_l = Armature leakage reactance
 - X_a = Armature reaction reactance
 - \bar{I}_a = Armature current
 - \bar{V}_a = Terminal voltage

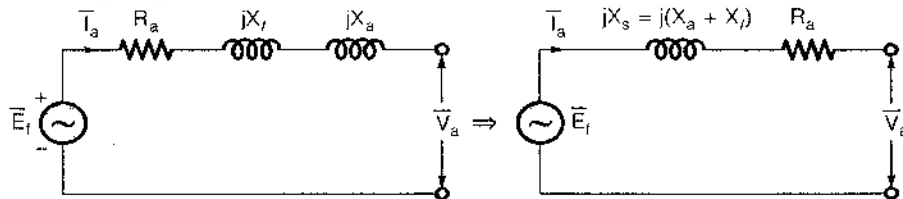

$$\bar{E}_f = \bar{V}_a + \bar{I}_a R_a + j\bar{I}_a X_s$$

where, $X_s = X_l + X_a$ = synchronous reactance

$$\bar{E}_f = \bar{V}_a + \bar{I}_a Z_s$$

where, $Z_s = (R_a + jX_s)$ = synchronous impedance

Drop in Voltage

- Drop due to armature resistance i.e. $I_a R_a$.
- Drop due to armature leakage reactance i.e. $I_a X_l$ (due to armature leakage flux).
- Drop due to armature reaction i.e. $I_a X_a$.

Remember:

- The terminal voltage of an a.c. generator depends upon the load and may be larger or smaller than the generated voltage.
- The terminal voltage may actually be higher than the generated voltage when the power factor is leading.
- For unity and lagging power factor, the terminal voltage is smaller than the generated voltage.

Phasor diagram

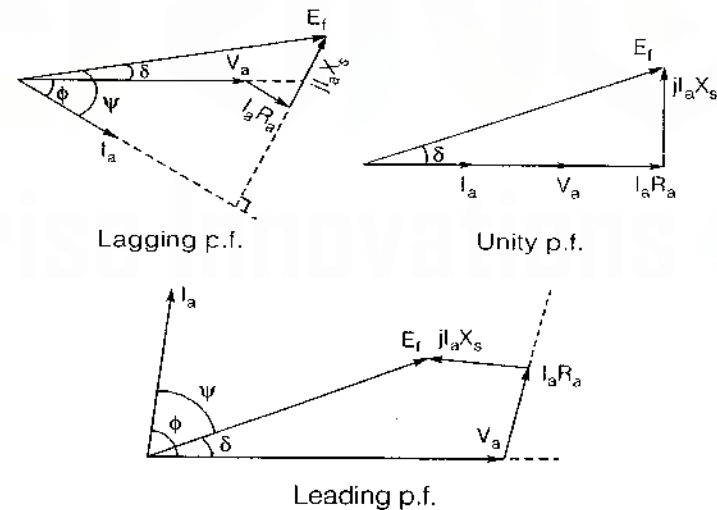

Note:

- When $E_f \cos\delta = V_a$ normal excitation (unity p.f.)
- When $E_f \cos\delta > V_a$ Over excited machine (lagging p.f.)
- When $E_f \cos\delta < V_a$ Under excited machine (leading p.f.)

Synchronous generator tests and characteristics

Resistance test

- Per phase resistance for star connected generator

$$R_a = 0.5R_L$$

for delta connected generator

$$R_a = 1.5R_L$$

where, R_L = measured value of resistance

Open circuit and Short circuit characteristics

- Find the value of the field current (I_{fr}) that gives the rated per-phase voltage (V_{anL}) from the OCC of the generator.
- Find the value of the short-circuit current (I_{sc}) from the SCC for the same value of the field current I_{fr} .

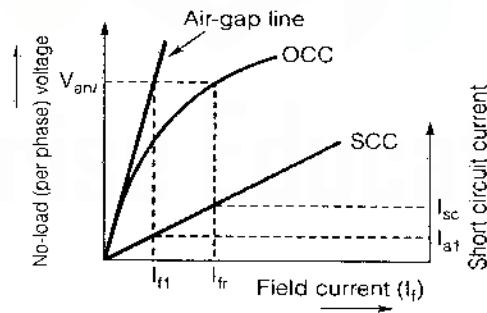

□ Synchronous impedance

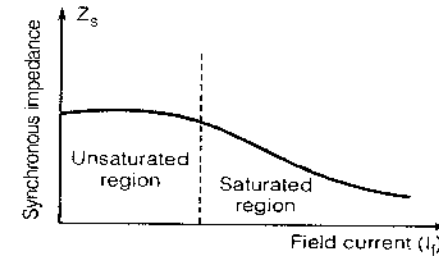

$$Z_s = \frac{\text{Open circuit terminal voltage for a certain field current}}{\text{Short-circuit current for the same field current}}$$

$$Z_s = \frac{V_{anL}}{I_{sc}}$$

External characteristics

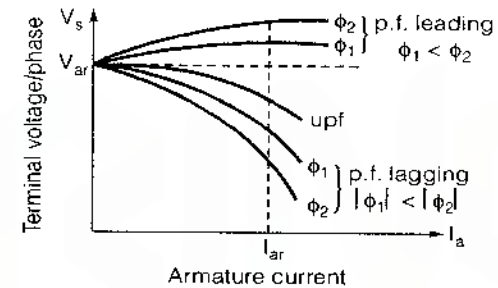

Short Circuit Ratio (SCR)

SCR is defined as ratio of field current required to produce rated voltage on open circuit to the field current required to produce rated armature current on short circuit.

$$SCR = \frac{I_f \text{ for rated open circuit voltage}}{I_f \text{ for rated short circuit current}}$$

$$SCR = \frac{I_{sc}}{I_{rated}} = I_{sc} \text{ (p.u.)}$$

$$SCR = \frac{1}{X_{s(saturated)} \text{ p.u.}}$$

Remember:

- For hydro generator SCR is high.
- For turbo generator SCR is low.
- A synchronous machine with high value of SCR has a better voltage regulation and improved steady-state stability limit but short circuit fault current in armature is high.
- A machine with low SCR is less stable when operating in parallel with other generators. But the armature current under short circuit conditions is small.

Voltage Regulation

Voltage regulation is defined as, rise in voltage expressed as a fraction of full load rated voltage when full load is thrown off, while keeping the excitation constant.

$$\text{Regulation} = \frac{|E_f| - |V_a|}{|V_a|}$$

$$\text{Regulation} \propto Z_s$$

Remember:

- Order of voltage regulation in alternator is 30 to 40%.

For minimum voltage regulation

Zero voltage regulation is possible only for leading p.f. load.

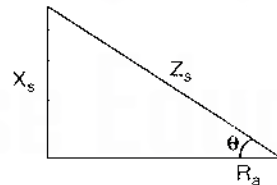

For zero regulation:

$$\cos(\theta + \phi) = \frac{-I_a Z_s}{2V} \quad \text{or} \quad \theta + \phi = 90^\circ$$

where,

θ = Impedance angle

ϕ = Power factor angle

Maximum voltage regulation

Maximum regulation is possible only for lagging pf load.

For maximum regulation:

$$\text{Load p.f. angle } (\phi) = \text{Impedance angle } (\theta)$$

Remember:

- Voltage regulation is always positive for resistive load or U.P.F. load or lagging p.f. load.
- Voltage regulation could be positive (for high leading p.f.), zero and negative for leading p.f. load.

Voltage Regulation Method**1. Synchronous Impedance Method (EMF Method)**

Here we assume drop due to armature reaction is considered drop due to leakage reactance. It gives regulation more than the actual value and hence it is called as pessimistic method.

2. M.M.F. Method (Amp-turn method)

Here, we assume drop due to leakage reactance is considered as drop due to armature reaction. This method gives regulation less than actual value therefore it is called as optimistic method.

3. Z.P.F. Method

Plot of V_a versus I_a corresponding to different field current. For maintaining rated armature current at zero p.f. lag called ZPF characteristic or potier triangle characteristic.

4. A.S.A. Method

Here effect of saturation is also considered. This method is combination of Z.P.F. and M.M.F. method.

Note:

$$\text{Voltage regulation } \boxed{\text{EMF} > \text{ASA} > \text{ZPF} > \text{MMF}}$$

Two Reaction Theory

This theory is applicable to salient pole machines only.

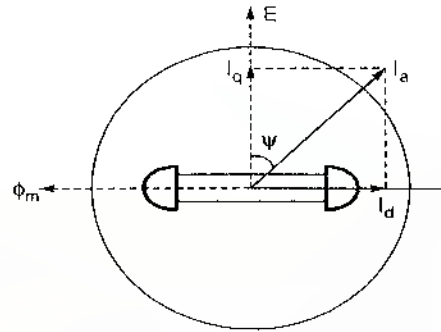

$$I_d = I_a \sin \psi$$

$$I_q = I_a \cos \psi$$

where, I_d = Direct axis armature current
 I_q = Quadrature axis armature current

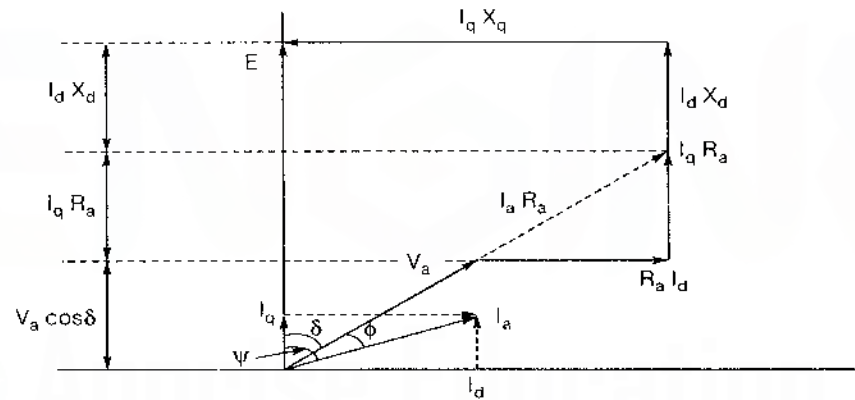

$$E = V_a \cos \delta + I_q R_a \pm I_d X_d$$

$$\tan \psi = \frac{V_a \sin \phi \pm I_a X_q}{V_a \cos \phi + I_a R_a}$$

$$\psi = \delta \pm \phi$$

here, + sign for lagging p.f. and - sign for leading p.f.

where, ψ = internal pf angle by which I_a lags E .
 δ = Load angle between E and V
 ϕ = Power factor angle between V_a and I_a

□ If R_a neglected as $R_a \ll X_s$.

$$I_d = \frac{E - V_a \cos \delta}{X_d} \quad \text{and} \quad I_q = \frac{V_a \sin \delta}{X_q}$$

□ Per Phase Power

$$P = \underbrace{\frac{E V_a}{X_d} \sin \delta}_{\text{Electromagnetic power}} + \underbrace{\frac{V_a^2}{2} \left(\frac{1}{X_q} - \frac{1}{X_d} \right) \sin 2\delta}_{\text{Reluctance power (P_{rel.})}}$$

Remember:

- In cylindrical rotor, P_{rel} is zero since it does not have saliency and $X_d = X_q = X_s$.
- Reluctance power is generated only when machine is connected to or operating on infinite bus bar.

Slip Test

From slip test, the direct and quadrature axis synchronous reactances i.e. X_d and X_q can be determined.

$$X_d = \frac{\text{Maximum armature terminal voltage per phase}}{\text{Minimum armature current per phase}}$$

$$X_q = \frac{\text{Minimum armature terminal voltage per phase}}{\text{Maximum armature current per phase}}$$

Power Flow in Alternator

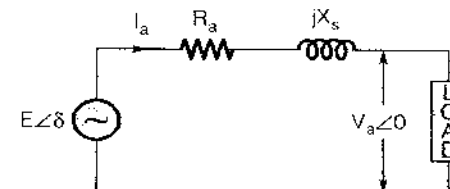

Complex power output

$$S = P + jQ = V_a I_a^*$$

$$P = \frac{E V_a}{Z_s} \cos(\theta - \delta) - \frac{V_a^2}{Z_s} \cos \theta$$

$$Q = \frac{E V_a}{Z_s} \sin(\theta - \delta) - \frac{V_a^2}{Z_s} \sin \theta$$

If, $R_a = 0$ then $Z_s = X_s$ and $\theta = 90^\circ$

$$P = \frac{E V_a}{X_s} \sin \delta$$

$$Q = \frac{V_a}{X_s} [E \cos \delta - V]$$

- Condition for maximum power output i.e. $\frac{dP}{d\delta} = 0$

$$\text{impedance angle } (\theta) = \text{load angle } (\delta)$$

Note:

Always replace δ by θ .

$$P_{\max} = \frac{E V_a}{Z_s} - \frac{V_a^2}{Z_s} \cos \theta$$

Power relationship

- Mechanical power input to the generator

$$P_{in,m} = T_s \omega_s$$

- D.C. power input to a wound rotor

$$P_{in,e} = V_f I_f$$

- Total power input

$$P_{in} = T_s \omega_s + V_f I_f$$

- Power output of a synchronous generator

$$P_o = 3 V_a I_a \cos \phi$$

- Copper loss in armature winding

$$P_{cu} = 3 I_a^2 R_a$$

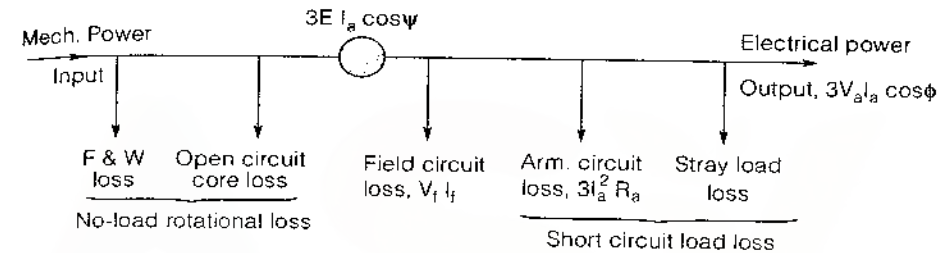

- Total power input to synchronous generator

$$P_{in} = 3 V_a I_a \cos \phi + 3 I_a^2 R_a + P_r + P_{st} + V_f I_f$$

where, P_r = Rotational losses of synchronous generator
 P_{st} = Stray load losses

- Constant losses

Since the rotor revolves at a constant speed, the rotational loss is constant. The field-winding loss is constant. Assuming the stray-load loss to be a constant.

$$P_c = P_r + P_{st} + V_f I_f$$

Efficiency

- Efficiency of the generator

$$\eta = \frac{3 V_a I_a \cos \phi}{3 V_a I_a \cos \phi + P_c + 3 I_a^2 R_a}$$

For the maximum efficiency

$$3 I_a^2 R_a = P_c$$

Condition that must be satisfied for parallel operation

- Terminal voltage of incoming alternator should be equal to existing system and that can be done by varying excitation.
- Frequency of incoming alternator should be equal to existing system. Frequency is maintained same by adjusting primover speed.
- Phase sequency of incoming alternator must be same as that of existing system.

Constant power loci of armature current with generated voltage

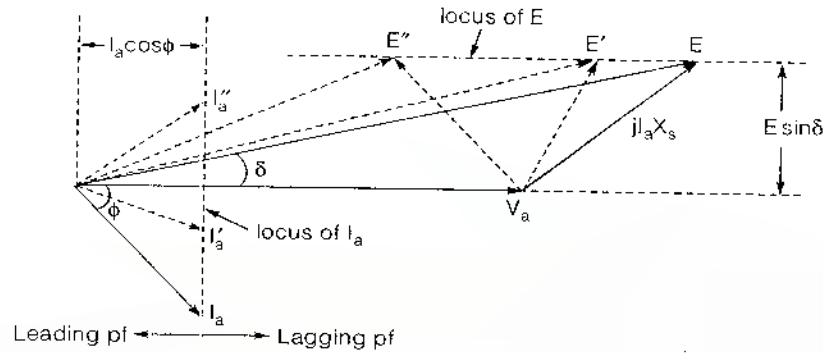

V curves

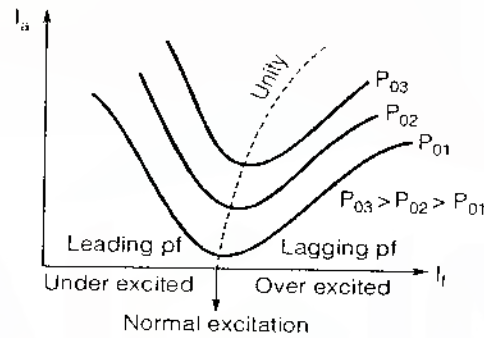

Round-Rotor synchronous motors

Equivalent circuit

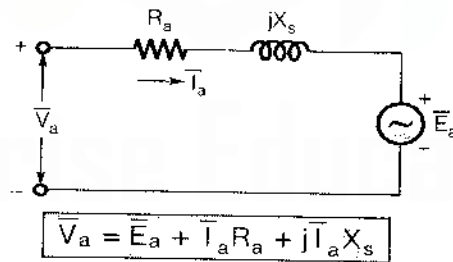

Phasor diagram

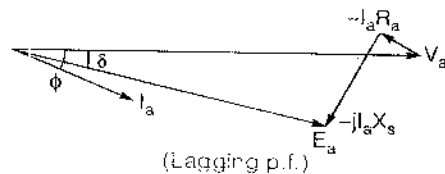

Power flow diagram

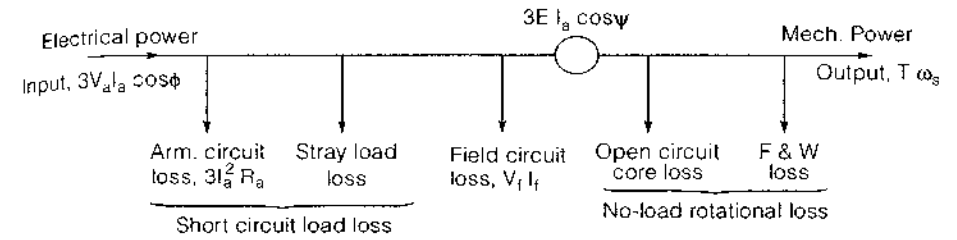

Average power input

$$P_{in} = 3 V_a I_a \cos \phi + V_f I_f$$

Total copper loss

$$P_{cu} = 3 I_a^2 R_a$$

Power developed

$$P_d = 3 V_a I_a \cos \phi - 3 I_a^2 R_a - V_f I_f - \text{stray load loss}$$

Salient-pole synchronous motor

$$\bar{V}_a = \bar{E}_a + \bar{I}_a R_a + j \bar{I}_d X_d + j \bar{I}_q X_q \quad \text{or}$$

$$\bar{E}_a = \bar{V}_a - \bar{I}_a R_a - j \bar{I}_a X_q - j \bar{I}_d (X_d - X_q)$$

Phasor diagrams

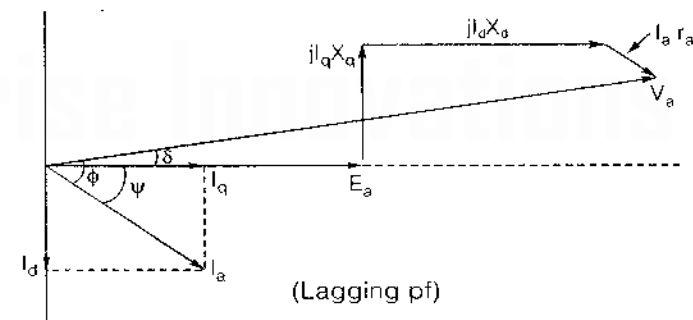

□ Power developed

$$P_d = \frac{3V_a E_a \sin \delta}{X_d} + \frac{3}{2} V_a^2 \sin 2\delta \left[\frac{X_d - X_q}{X_d X_q} \right]$$

□ Power developed owing to field excitation

$$P_{df} = \frac{3V_a E_a \sin \delta}{X_d}$$

□ Power developed due to the saliency of rotor

$$P_{ds} = 3V_a^2 \left(\frac{X_d - X_q}{2X_d X_q} \right) \sin 2\delta$$

Condition for maximum power

$$\tan \delta_m = \frac{X_s}{R_a}$$

□ Per-phase maximum power developed

$$P_{dma} = \frac{V_a E_a}{Z_s} - \frac{E_a^2 R_a}{Z_s^2}$$

Constant power loci of armature current and excitation voltage

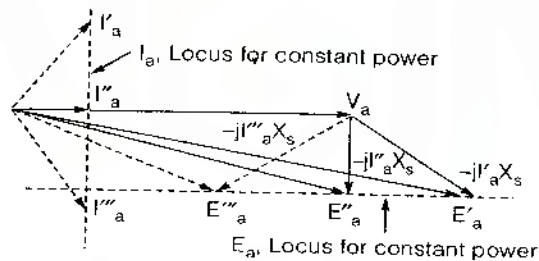

V curves

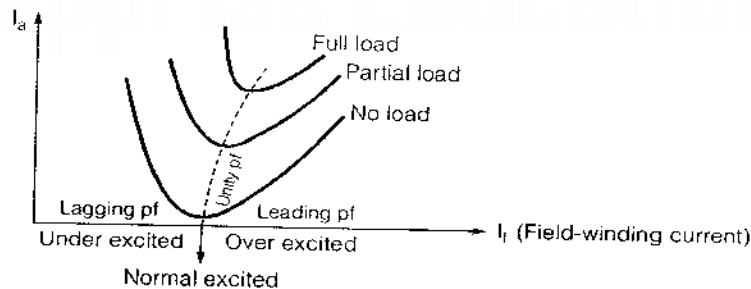

Starting of Synchronous Motors

A synchronous motor is not self-starting. It can be started by the following two methods:

- Starting with the help of an external prime mover.
- Starting with the help of damper windings.

Hunting or Phase Swinging

The phenomenon of oscillation of rotor about its final equilibrium position is called hunting. Since during rotor oscillations, the phase of the phasor \$E_f\$ changes relation to phasor \$V\$ hunting is known as phase swinging.

Hunting occurs not only in the synchronous motors but also in synchronous generators upon the abrupt change in loading.

Synchronous Condenser

It is a synchronous motor running without a mechanical load which can generate or absorb reactive VAR by varying the excitation of its field winding.

Remember:

- Since, a synchronous condenser behaves like variable inductor or a variable capacitor, it is used in power transmission systems to regulate line voltage.
- They are also used in constant speed applications.

A Handbook on Electrical Engineering

3

Power Electronics

CONTENTS

1. Power Electronics	139
2. Thyristor	147
3. Diode Circuits and Rectifiers	155
4. Thyristor Commutation Techniques	166
5. Phase Controlled Rectifiers	173
6. Choppers	194
7. Inverters	199
8. AC Voltage Controllers	211
9. Electric Drives	215

power Electronics

1

Power electronics is a subject that deals with the apparatus and equipment rated at power level (high voltage, high current and high power) rather than signal level and working on the principle of electronics.

Example: Thyristor, GTO, Power MOSFET, Power IGBT, TRIAC etc.

Power Device	Signal Device
1. Voltage and current rating is high	1. Voltage and current rating is low
2. Power handling capability is high	2. Power handling capability is low
3. Operate at power frequency	3. Operate at high frequency

Power Semiconductor Devices

Power semiconductor devices can be classified based on their

- (i) Turn-on and turn-off characteristics.
 - (ii) Gate signal requirements.
- (a) **Diodes:** These are uncontrolled rectifying devices and their ON state and OFF state are controlled by nature of power supply.
- (b) **Thyristors:** These devices have controlled turned-on by a gate signal. These devices are also called as semiconrolled devices.
- (c) **Controllable switches:** Turn-on and turn-off of these devices can be done by application of control signals.

Power Diodes

Power diode is a 2 layer, 2 terminal p-n junction semiconductor device. It has one p-n junction formed by alloying, diffusion or epitaxial growth.

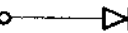
A(anode)  K(cathode)

Remember:

- When voltage rating is less than 400 V epitaxial process is used for diode fabrication.
- When voltage rating is greater than 400 V diffusion process is used for diode fabrication.

Characteristics of Power Diodes

(a) Diode V-I Characteristics

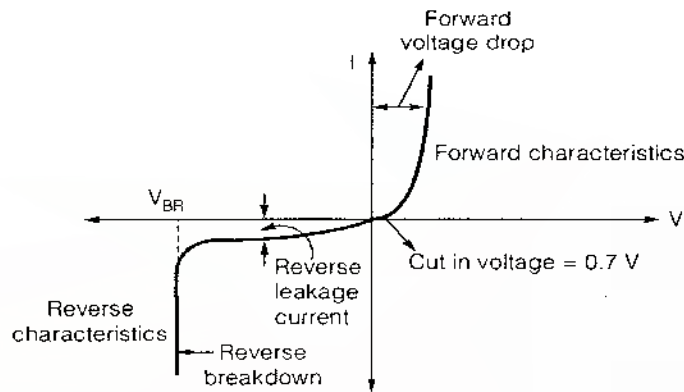

Characteristics of Semiconductor Diode

Note:

Peak inverse voltage (P.I.V.) specifies the maximum reverse voltage applied across diode by the source.

- If (a) P.I.V. < V_{BR}, diode remain in blocking state.
- (b) P.I.V. > V_{BR}, breakdown occurs and diode starts conducting in reverse direction.

(b) Reverse Recovery Characteristics

Due to the presence of excess stored charge carrier in the depletion region of diode, a reverse current immediately flow as soon as the forward diode current becomes zero.

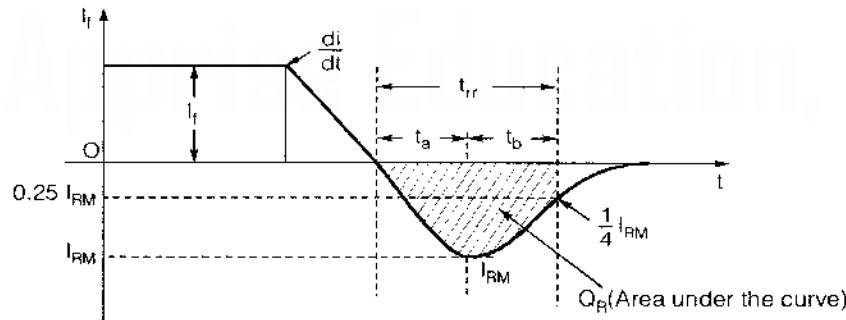

Reverse Recovery Characteristics

$$t_{rr} = t_a + t_b = t_{off}$$

where,

t_{rr} = Reverse recovery time

t_a = Time between I_A = 0 to I_A = I_{RM}

t_b = Time between I_{RM} to 25% of I_{RM}

I_{RM} = Reverse peak current.

$$t_{rr} = \left[\frac{2Q_R}{di/dt} \right]^{1/2} \quad \text{and} \quad I_{RM} = \left[2Q_R \left(\frac{di}{dt} \right) \right]^{1/2}$$

where, Q_R gives the amount of excess charge stored.

□ Softness factor (S)

It is measure of voltage transient appearing across the terminal of diode during recovery period.

$$S = \frac{t_b}{t_a}$$

when S = 1 ; t_a = t_b ; Soft recovery

S << 1 ; Voltage spikes will be present and it indicates fast recovery.

Types of Power Diode

Parameters	General Purpose Diode	Fast Recovery Diode	Schottky Diode
t _{rr}	25 μsec.	5 μsec or less	In nano second
Voltage rating	50 V to 5 kV	50 V to 3 kV	Reverse voltage blocking capability limited to 100 Volts.
Current rating	1 A to 1000 A	1 A to 1000 A	1 A to 300A
Application	(i) Battery charging (ii) Electric traction (iii) UPS (iv) Welding	(i) Choppers (ii) Commutation circuits (iii) SMPS (iv) Induction heating	(i) High frequency Instrumentation (ii) Switching power supplies

Power Transistor

1. Power BJT (Bipolar Junction Transistor).
2. MOSFET (Metal-Oxide Semiconductor Field Effect Transistor)
3. Power IGBT (Insulated Gate Bipolar Transistor)

Power BJT

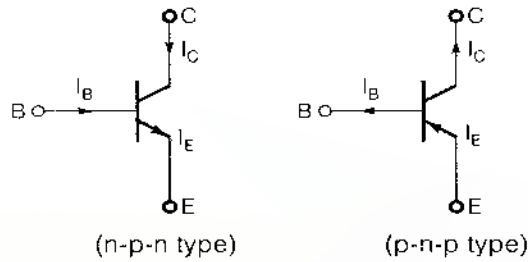

where, C, E = Main terminal
B = Control terminal

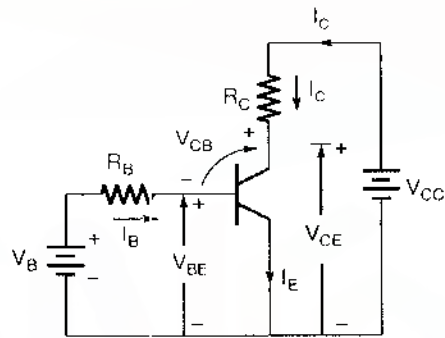

(a) npn transistor circuit characteristics

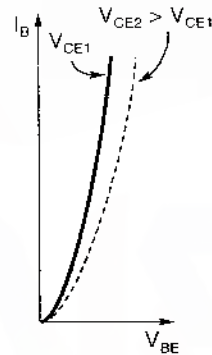

(b) Input characteristics

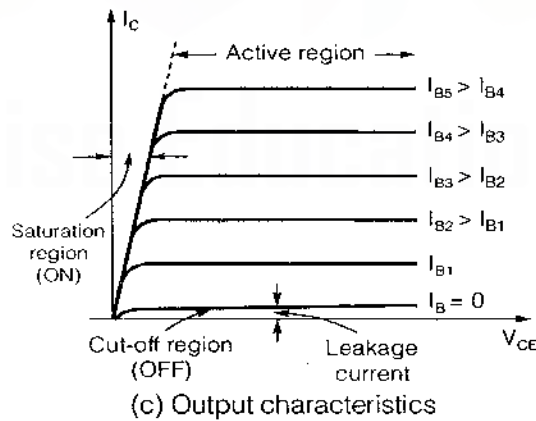

(c) Output characteristics

Remember:

- In switching operation : Cut-off region → OFF state
Saturation region → ON state
- Active region is not used for switching application.
- Current flow in the device is due to the movement of both holes and electrons.

Switching Characteristics of n-p-n Transistor

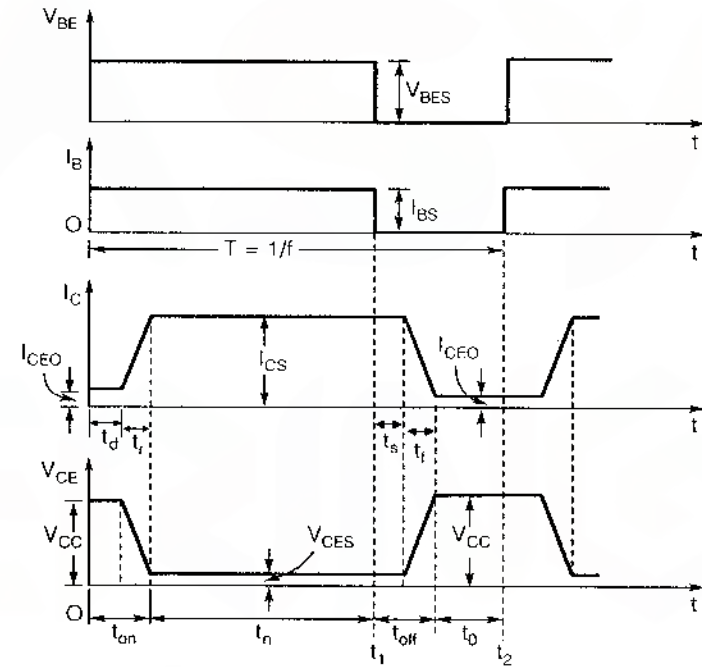

- where,
- t_d = Delay time
 - t_r = Rise time
 - $t_{on} = t_d + t_r$
 - t_n = Conduction period
 - t_s = Storage time
 - t_f = Fall time
 - t_o = OFF period
 - $t_{off} = t_s + t_f$

V_{CES} = Small saturation voltage between collector and emitter
 I_{CS} = Collector saturation current

$$T = t_{on} + \text{Conduction period} + t_{off} + \text{OFF Period}$$

$$\text{frequency } (f) = 1/T$$

Remember:

t_{on} is in order of 30 to 300 ns.

Safe Operating Region for Power Transistor

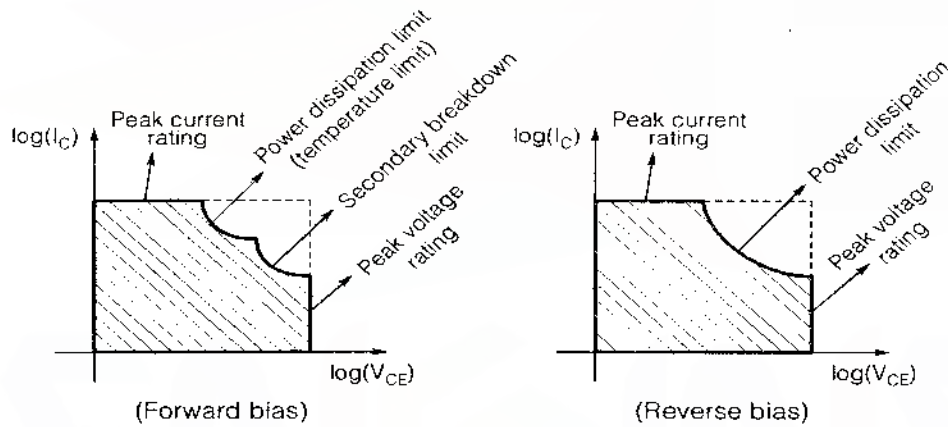

Power MOSFET

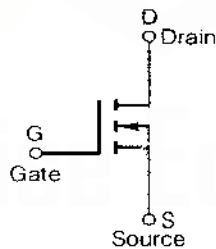

N-channel enhancement power MOSFET

where,

D, S = Main terminal

G = Control terminal

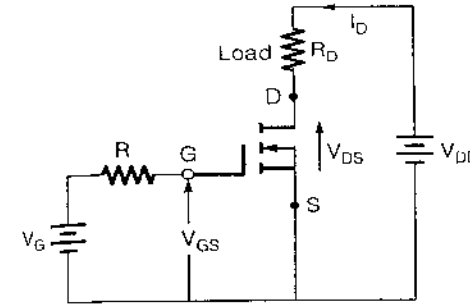

n-channel power MOSFET circuit diagram

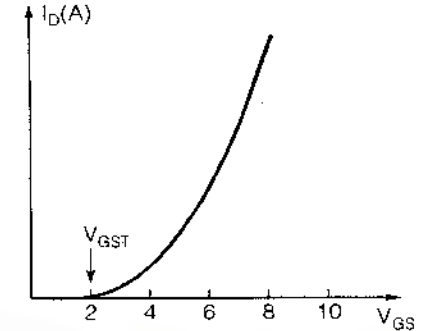

Transfer characteristic

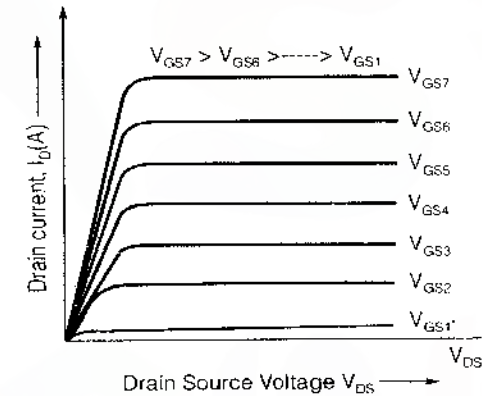

Output characteristics of a power MOSFET

Remember:

- n-channel enhancement MOSFET is more common because of higher mobility of electrons.
- The control signal (IB) in BJT is much larger than the control signal (Gate current) required in a MOSFET.

Power IGBT

This device combines into it the advantages of both MOSFET and BJT.

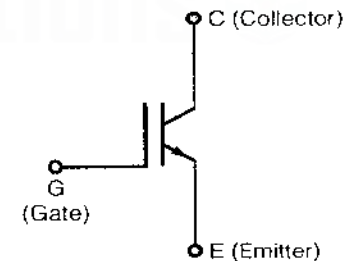

Circuit Symbol

IGBT Characteristics

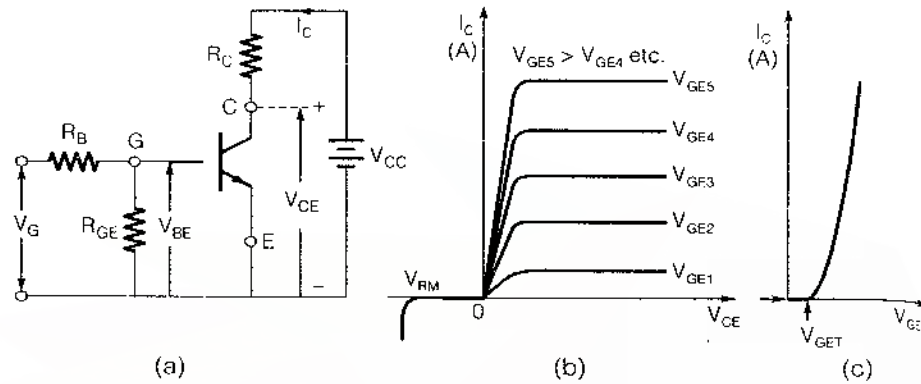

IGBT (a) Circuit diagram (b) Static V-I characteristics and (c) Transfer characteristics

Comparison

BJT	MOSFET	IGBT
1. Bipolar device	1. Unipolar device	1. Bipolar device
2. Low ON-state voltage drop	2. High ON-state voltage drop	2. Low ON-state voltage drop
3. Low ON state conduction power loss	3. High ON state conduction power loss	3. Low ON state conduction power loss
4. High switching power loss	4. Low switching power loss	4. Low switching power loss
5. Low input impedance	5. High input impedance	5. High input impedance
6. Current contro led device	6. Voltage controlled device	6. Voltage controlled device
7. Negative temperature coefficient for resistance	7. Positive temperature coefficient for resistance	7. Positive temperature coefficient for resistance
8. Secondary break down occur	8. Secondary break down will not occur	8. Secondary break down will not occur
9. Parallel operat on is not advisable	9. Parallel operation is possible	9. Parallel operation is possible
10. 1200 V, 800 A, (10-20) kHz	10. 500 V, 140 A, 1 MHz	10. 1200 V, 500 A, 50 kHz
11. Application: UPS, charging batteries	11. SMPS	11. Inverters, choppers



Thyristor

Thyristor is a four layer, 3 junction, 3 terminal semiconrolled p-n-p-n semiconductor switching device.

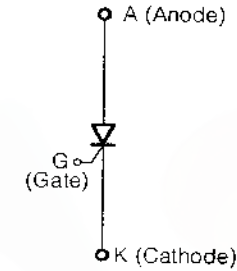

(Circuit Symbol)

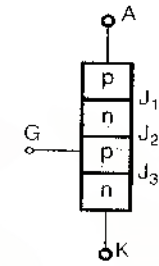

(Schematic diagram)

Static V-I Characteristics of Thyristor

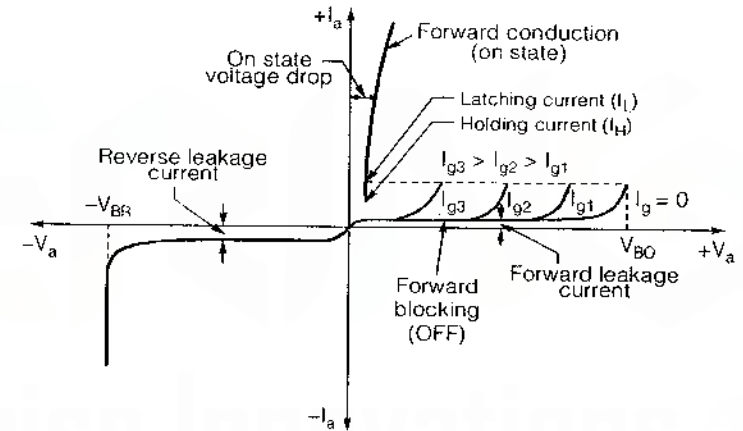

where, V_{BO} = Forward breakover voltage
 V_{BR} = Reverse breakover voltage
 I_g = Gate current

Thyristor Operates in Three-Region

1. Forward blocking mode:

Device is in OFF state. Anode is positive, cathode is negative and $V_a < V_{BO}$

$$I_g = 0$$

Junction: $J_1 \rightarrow$ Forward bias
 $J_2 \rightarrow$ Reverse bias
 $J_3 \rightarrow$ Forward bias

Only forward leakage current flow.

2. Forward conduction mode:

Device is in ON state. Anode is positive, cathode is negative and $V_a > V_{BO}$

$$I_g = 0$$

Junction: $J_1 \rightarrow$ Forward bias
 $J_2 \rightarrow$ Breakdown occur
 $J_3 \rightarrow$ Forward bias

3. Reverse Blocking mode:

Device is in OFF state. Anode is negative, cathode is positive.

$$I_g = 0$$

Junction: $J_1 \rightarrow$ Reverse bias
 $J_2 \rightarrow$ Forward bias
 $J_3 \rightarrow$ Reverse bias

□ Latching Current (I_L)

It is the minimum anode current to be attained above which the device continues to be in the ON state even after removal of the gate current.

□ Holding Current (I_H)

It is the minimum anode current to be attained below which the device comes into the OFF state after applying a reverse voltage across it until it regains its blocking capability.

□ Procedure to Turn-off the SCR

Bring down the anode current below holding current. After that apply a reverse voltage across it till excess carrier are removed and it regains its blocking capability.

Remember:

- By increasing the magnitude of Gate signal the breakdown voltage reduces.
- Latching current is related to turn-on process and holding current is related to turn-off process.
- $I_L > I_H$ or $I_L \approx I_H$.

- The Gate signal needs to provide until, the anode current is just above the latching value, so that it continuous to be in ON state even after removing gate signal.
- Gate loses the control after SCR is turn-on, that's why it is called partially controlled device.
- By increasing the value of load inductance the minimum pulse width required to turn-on the SCR is also increase.
- By increasing the value of resistance connected in series with inductive load, the minimum gate current width require is constant.
- By adding a resistance in parallel with load resistance the minimum pulse width is changed.

Switching Characteristics of Thyristor

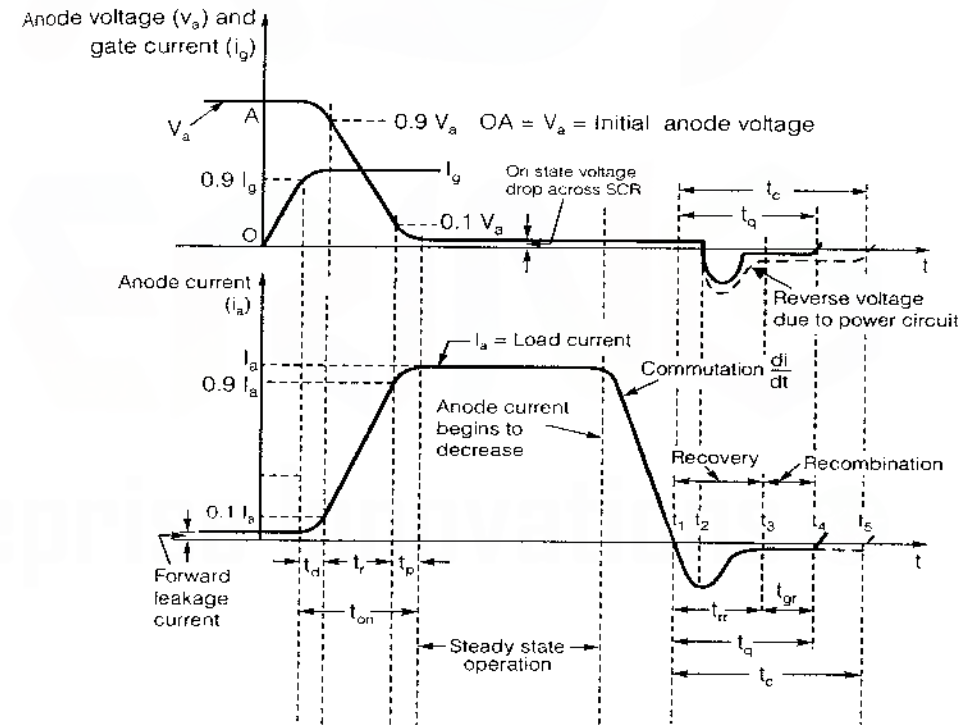

Turn-on Characteristics	Turn-off Characteristics
Delay time (t_d) = $0.9 I_g$ to $0.1 I_a$	$t_q = t_{off} = t_{rr} + t_{gr}$
Rise time (t_r) = $0.1 I_a$ to $0.9 I_a$	t_q = Device turn-off time
Spread time (t_p) = $0.9 I_a$ to I_a	t_{rr} = Reverse recovery time
	t_{gr} = Gate recovery time
	t_c = Circuit turn-off time

Remember:

For successful commutation, $t_c > t_q$

Triggering Methods of SCR

- (i) Forward voltage triggering.
- (ii) Gate triggering
- (iii) dv/dt triggering
- (iv) Temperature triggering
- (v) Light triggering

Remember:

- Light triggering thyristors are used in HVDC transmission system.
- The size of pulse transformer and average gate power dissipation can be reduced by using high frequency gating.

String Efficiency

It is measure of utilisation of SCRs rating to its full capacity.

$$\text{String efficiency} = \frac{\text{Total string voltage/current rating}}{n \text{ (individual voltage/current rating of one SCR)}}$$

where, n = Number of SCRs connected in series/parallel.

$$\text{Derating factor} = 1 - \text{String efficiency}$$

Series Connection of SCR

When the available voltage rating of SCR is not sufficient then we have to connect some of the SCR in series so that they share the applied voltage during the off-state.

Problem Related to Series Connected SCR

Unequal Sharing of Voltage:

- a) Due to difference in forward blocking characteristics of series connected SCR. To overcome this problem, we use "static equalizing circuit".
- b) Due to difference in the reverse recovery characteristic. To overcome this problem, we use "dynamic equalising circuit".

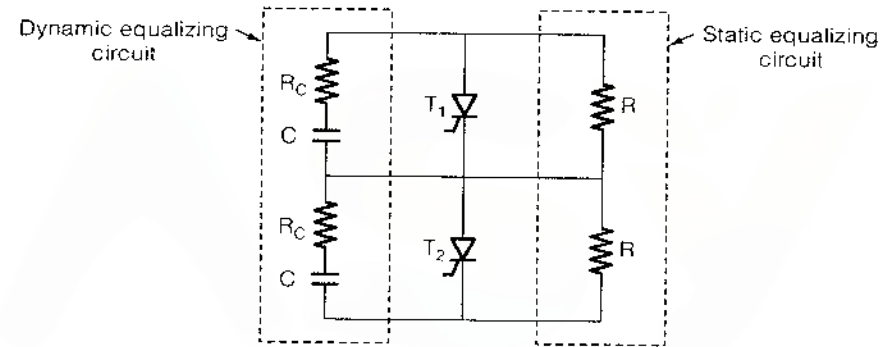

$$R = \frac{nV_{bm} - V_s}{(n-1) \Delta I_b}$$

$$C = \frac{(n-1) \Delta Q_R}{nV_{bm} - V_s}$$

V_{bm} = Maximum permissible blocking voltage

$\Delta I_b = I_{b(max)} - I_{b(min)}$

= Difference between maximum and minimum leakage current

n = Number of SCR connected in series

V_s = Total string voltage

ΔQ_R = Difference in recovery charge

Parallel Connection of SCR

When available current rating of the SCR is not sufficient then we have to connect some of the SCRs in parallel.

Problem Related to Parallel Connected SCR

Unequal sharing of current:

- a) Due to difference in conduction characteristics of both SCR connected in parallel. To overcome this problem connect current equalising circuit.
- b) Due to temperature difference and to overcome this problem we put all SCR in a common symmetrical heat sink.

Thermal Resistance

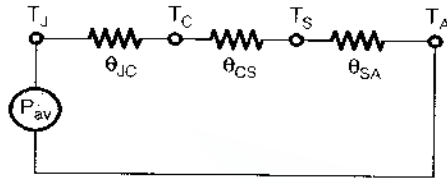

- where, P_{av} = Average rate of heat generated
 T_J = Junction temperature
 T_C = Case temperature
 T_S = Sink temperature
 T_A = Ambient temperature
 θ_{JC} = Thermal resistance between junction and case
 θ_{CS} = Thermal resistance between case and sink
 θ_{SA} = Thermal resistance between sink and ambient

$$P_{av} = \frac{T_J - T_C}{\theta_{JC}} = \frac{T_C - T_S}{\theta_{CS}} = \frac{T_S - T_A}{\theta_{SA}} = \frac{T_J - T_A}{\theta_{JA}}$$

$$\theta_{JA} = \theta_{JC} + \theta_{CS} + \theta_{SA}$$

Protection of Thyristor

- (i) **Over current protection:** Fuse or circuit breaker connected in series with SCR to limit over-current.
- (ii) **Over voltage protection:** Varistor are connected across SCR.
- (iii) **High dv/dt protection:** Snubber circuit is provided across SCR.
- (iv) **High di/dt protection:** Connect a inductor in series with SCR.
- (v) **Thermal protection:** Provide heat sink in SCR.

Gate Protection

- (i) **Over current protection:** Connect a resistance in series with Gate.
- (ii) **Over voltage protection:** Zener diode is connected across the gate and cathode junction.
- (iii) **Protection against noise:** Connect a capacitor and a resistor across gate and cathode.

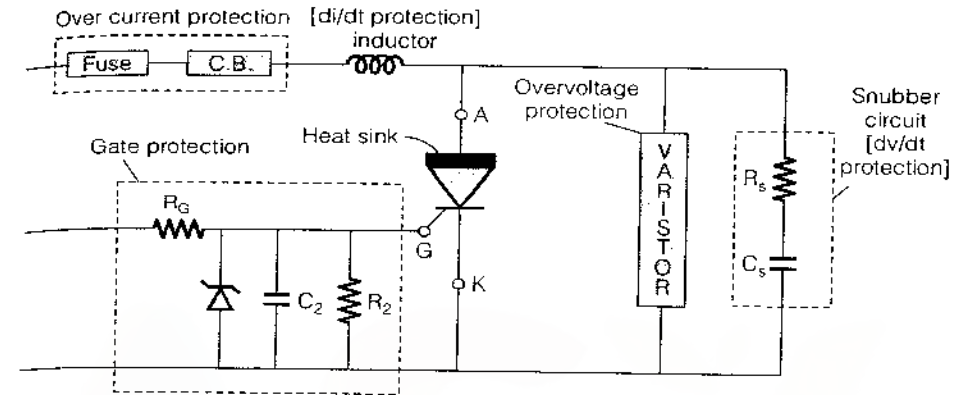

Circuit for protection of SCR

Remember:

- Gate current magnitudes are of the order of 20 to 200 mA.
- Triac is combination of antiparallel connection of two SCR.
- Diac is antiparallel connection of two SCR when $I_g = 0$.

Device	Circuit symbol	Voltage/current ratings
Diode	A K	5000 V 5000 A
Thyristors		
(a) SCR	A K G	7000 V 5000 A
(b) LASCR	A K G	6000 V 3000 A
(c) ASCR/RCT	A K G	2500 V 400 A
(d) GTO	A K or A K G	5000 V 3000 A
(e) SITH	A K	2500 V 500 A

(f) MCT		1200 V 40 A
(g) Triac		1200 V 1000 A
Transistors		
(a) BJT		1400 V 400 A
(b) MOSFET (n-channel)		1000 V 50 A
(c) SIT		1200 V 300 A
(d) IGBT		1200 V 500 A



Diode Circuits and Rectifiers

Diode circuits with DC source

(a) Resistive Load

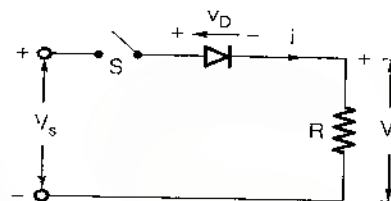

□ Load current

$$i(t) = \frac{V_s}{R}$$

where, V_s = D.C. source voltage
 R = Load resistance

(b) RC Load

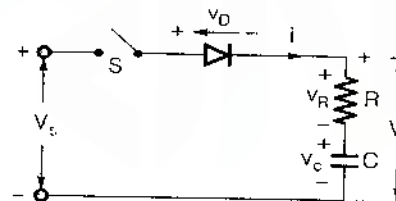

□ Load current

$$i(t) = \frac{V_s}{R} e^{-t/RC}$$

□ Voltage across capacitor

$$v_c(t) = V_s(1 - e^{-t/RC})$$

where, $v_c(t)$ = Voltage across capacitor at time t

- Initial rate of rise of capacitor voltage

$$\left(\frac{dV_c}{dt}\right)_{t=0} = \frac{V_s}{RC}$$

- Time constant

$$\tau = RC = \frac{\text{Source voltage } (V_s)}{\left(\frac{dv_c}{dt}\right)_{t=0}}$$

Remember:

At $t = 0$, capacitor acts as a conductor and at $t \rightarrow \infty$, it acts as an insulator.

(c) RL load

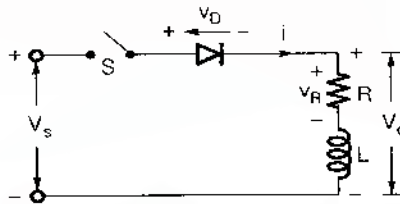

- Load current

$$i(t) = \frac{V_s}{R} \left(1 - e^{-\frac{R}{L}t}\right)$$

- Voltage across inductor

$$v_L(t) = V_s \cdot e^{-\frac{R}{L}t}$$

- Initial rate of rise of current

$$\left(\frac{di}{dt}\right)_{t=0} = \frac{V_s}{L}$$

Remember:

At $t = 0$, inductor acts as an insulator and at $t \rightarrow \infty$, it acts as a conductor.

(d) LC load

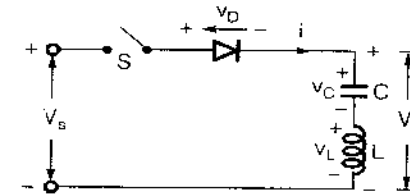

- Load current

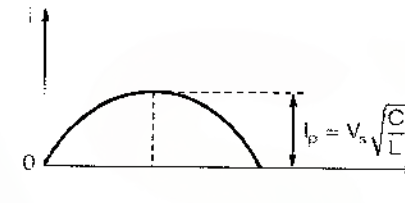

$$i(t) = V_s \sqrt{\frac{C}{L}} \sin \omega_0 t$$

where, ω_0 = Resonant frequency of the circuit

$$\omega_0 = \frac{1}{\sqrt{LC}}$$

- Voltage across capacitor

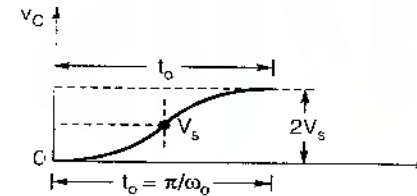

$$v_C(t) = V_s(1 - \cos \omega_0 t)$$

- Voltage across inductor

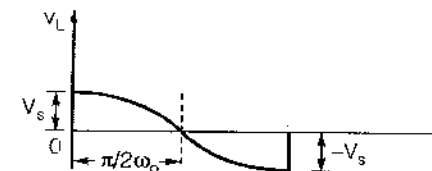

$$v_L(t) = V_s \cos \omega_0 t$$

Conduction time

$$t_0 = \frac{\pi}{\omega_0} = \pi\sqrt{LC}$$

Remember:

- If we provide D.C. voltage to LC parameter, the current will be alternating in nature.
- In LC circuit when current follow sine curve, voltage follow cosine curve. This characteristic is used in commutation technique.

(e) RLC load

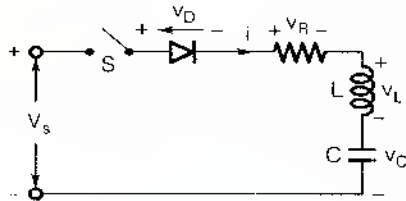

Characteristic equation

$$s^2 + \frac{R}{L}s + \frac{1}{LC} = 0$$

Damping factor

$$\alpha = \frac{R}{2L} = \xi\omega_0$$

Ringing frequency

$$\omega_r = \sqrt{\omega_0^2 - \alpha^2} \text{ in rad/sec}$$

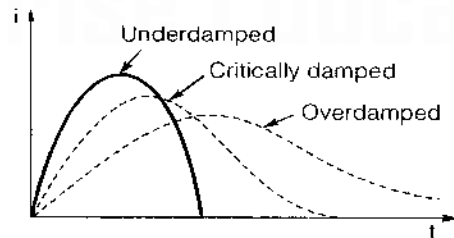

Case 1. $\alpha < \omega_0$

- Roots of characteristic equation are complex.
- Circuit is under damped.

$$i(t) = \frac{V_s}{\omega_r L} e^{-\alpha t} \sin \omega_r t$$

Case 2. $\alpha > \omega_0$

- Roots are real.
- Circuit is overdamped.

$$i(t) = \frac{V_s}{L\sqrt{\alpha^2 - \omega_0^2}} \sinh(\sqrt{\alpha^2 - \omega_0^2} t)$$

Case 3. $\alpha = \omega_0$

- Roots are equal.
- Circuit is critically damped.

$$i(t) = \frac{V_s}{L} \cdot t e^{-\alpha t}$$

Performance Parameters

- If V_s = RMS value of supply phase voltage
- I_s = RMS value of supply phase current including fundamental and harmonics
- I_{s1} = RMS value of fundamental component of supply current I_s

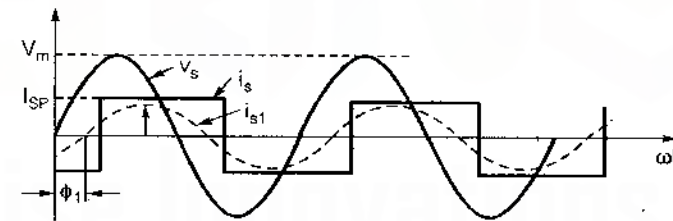

Input power factor

$$P.F. = \frac{\text{Mean ac input power}}{\text{Total rms input voltamperes}}$$

$$P.F. = \frac{I_{s1}}{I_s} \cos \phi_1$$

- RMS value of harmonic components

$$I_h = \sqrt{I_s^2 - I_{s1}^2}$$

- Input current harmonic factor (HF)

$$HF = \frac{I_h}{I_{s1}} \quad \text{or} \quad HF = \frac{\sqrt{I_s^2 - I_{s1}^2}}{I_{s1}}$$

- Crest factor (CF)

$$CF = \frac{I_{sp}}{I_s}$$

where, I_{sp} = Peak input current

- Form factor (FF)

$$FF = \frac{V_{or}}{V_o}$$

where V_{or} = RMS value of output voltage

V_o = Average value of output voltage

- Displacement factor (DF) = $\cos\phi_1$
- Ripple voltage (V_r)

$$V_r = \sqrt{V_{or}^2 - V_o^2}$$

- Voltage ripple factor (VRF)

$$VRF = \frac{V_r}{V_o}$$

- Transformer utilization factor (TUF)

$$TUF = \frac{P_{dc}}{V_s I_s}$$

where, V_s = RMS voltage of the secondary winding of transformer

I_s = RMS current of the secondary winding of transformer

$P_{dc} = V_o I_o$ = DC output power

V_o = Average output voltage

I_o = Average output current

Diode Rectifiers

A rectifier employing diode is called an uncontrolled rectifier, because its average output voltage is a fixed D.C. voltage.

1. Single Phase Half-Wave Diode Rectifier

- (a) Resistive Load:

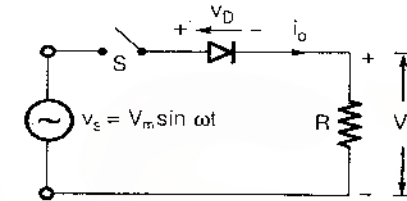

- Voltage rms value of output

$$V_{or} = \frac{V_m}{2}$$

where, V_m = Maximum value of source voltage (v_s)

- Average value of output voltage

$$V_o = \frac{V_m}{\pi}$$

- Power delivered

$P = (\text{RMS load voltage}) (\text{RMS load current})$

$$P = I_{or}^2 R$$

where, I_{or} = RMS value of load current

- Peak inverse voltage (PIV) = V_m

- Input power factor

$$\text{Input p.f.} = \frac{\text{Power delivered to load}}{\text{Input VA}}$$

$$\text{input p.f.} = \frac{V_{or} \cdot I_{or}}{V_s \cdot I_{or}} = 0.707$$

Remember:

Peak inverse voltage (PIV) is the maximum voltage that appears across the device during its blocking state.

(b) Inductive Load:

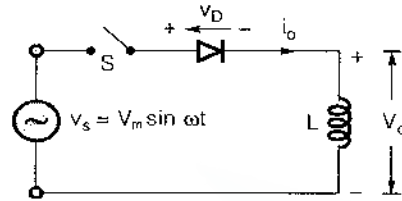

□ Output current

$$i_o = \frac{V_m}{\omega L} (1 - \cos \omega t)$$

□ Peak value of current

$$I_{\max} = \frac{2V_m}{\omega L}$$

□ Average value of current

$$I_o = \frac{1}{2} I_{\max}$$

□ RMS value of fundamental current

$$I_{1r} = \frac{I_o}{\sqrt{2}}$$

□ Output voltage

$$v_o = V_m \sin \omega t = v_s$$

□ Average value of output voltage

$$V_o = 0$$

(c) Capacitive Load

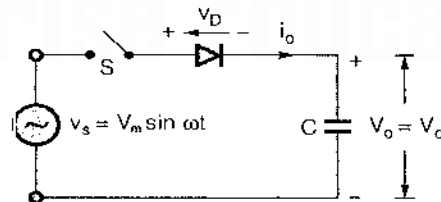

□ Output current

$$i_o = \omega C V_m \cos \omega t$$

□ Output voltage

$$v_o = V_m \sin \omega t = v_s = v_c$$

□ Diode voltage

$$v_D = V_m (\sin \omega t - 1)$$

□ Average value of Diode voltage

$$V_D = V_m$$

□ RMS value of diode voltage

$$V_{rD} = 1.225 V_m$$

(d) RE Load

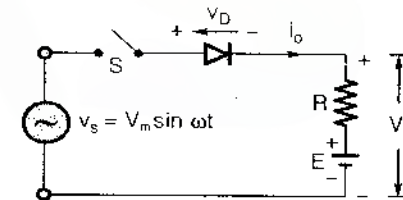

□ Turn-on angle

$$\theta_1 = \sin^{-1} \left(\frac{E}{V_m} \right)$$

□ Average value of output current

$$I_o = \frac{1}{2\pi R} [2V_m \cos \theta_1 - E(\pi - 2\theta_1)]$$

Note:

- Conduction angle for diode = $\pi - 2\theta_1$
- PIV for diode = $V_m + E$

(e) RL Load

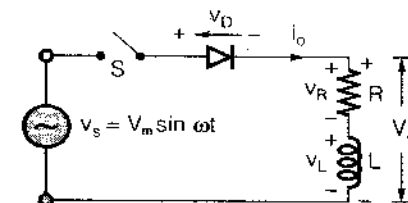

- Average value of output voltage

$$V_o = \frac{V_m}{2\pi} (1 - \cos \beta)$$

where, β = Extinction angle of the diode

- Average value of output current

$$I_o = \frac{V_m}{2\pi R} (1 - \cos \beta) \quad \text{For } 0 \leq \omega t \leq \beta$$

2. Single phase full wave diode rectifier

- Average output voltage

$$V_o = \frac{2V_m}{\pi}$$

- RMS value of output voltage

$$V_{or} = \frac{V_m}{\sqrt{2}}$$

Comparison of various 1- ϕ diode rectifier

Parameters	Half-wave	Full-wave	
		Centre-tap (M-2)	Bridge (B-2)
DC output voltage, V_o	$\frac{V_m}{\pi}$	$\frac{2V_m}{\pi}$	$\frac{2V_m}{\pi}$
RMS output voltage, V_{or}	$\frac{V_m}{2}$	$\frac{V_m}{\sqrt{2}}$	$\frac{V_m}{\sqrt{2}}$
Ripple voltage, V_r	$0.3856 V_m$	$0.3077 V_m$	$0.3077 V_m$
Voltage ripple factor, VRF	1.211	0.482	0.482
Rectifier efficiency, η	40.53%	81.06%	81.06%
TUF	0.2865	0.672	0.8106
PIV	V_m	$2V_m$	V_m
Crest factor, CF	2	$\sqrt{2}$	$\sqrt{2}$
Number of diodes	1	2	4
Ripple frequency	f	2f	2f

3. Three-phase half-wave diode rectifier

R Load

- Average value of output voltage

$$V_o = \frac{3\sqrt{6}}{2\pi} V_{ph} = \frac{3}{2\pi} V_{ml}$$

where, V_{mp} = Maximum value of phase voltage, V_{ph}

V_{ml} = Maximum value of line voltage, V_l

$$V_l = \sqrt{3} \cdot V_{ph}$$

Comparison of Various 3- ϕ Diode Rectifier

Parameters	3-Pulse Rectifier	6-Pulse Rectifier M-6 Type	6-Pulse Rectifier B-6 Type	12-Pulse Rectifier
DC output voltage, V_o	$\frac{3V_{ml}}{2\pi}$	$\frac{3V_{mp}}{\pi}$ or $\frac{\sqrt{3}V_{ml}}{\pi}$	$\frac{3\sqrt{3}V_{mp}}{\pi}$ or $\frac{3V_{ml}}{\pi}$	$1.91 V_{ml}$
RMS output voltage, V_{or}	$0.4854 V_{ml}$	$0.55185 V_{ml}$	$0.9558 V_{ml}$	$1.9101 V_{ml}$
Ripple voltage, V_r	$0.0872 V_{ml}$	$0.02356 V_{ml}$	$0.0408 V_{ml}$	$0.019545 V_{ml}$
Voltage ripple factor, VRF	0.1826 or 18.26%	0.043 or 4.3%	0.0427 or 4.27%	0.01023 or 1.023%
Rectifier efficiency, η	96.765%	99.82%	99.82%	-
TUF	0.6644	0.551	0.9541	-
PIV	V_{ml}	$1.155 V_{ml}$	V_{ml}	-
Form factor, FF	1.0165	1.0009	1.0009	1.00005



Thyristor Commutation Techniques

4

Commutation means bringing the thyristor from forward conduction state to forward blocking state i.e. it is a process of turning off a thyristor.

Remember:

- Commutation technique use resonant LC or underdamped RLC circuits to force the current or voltage of SCR to zero to turn-off the device.

Types of Commutation

- Natural Commutation (Line Commutation):** Here nature of supply take cares of commutation process.
Example: Phase controlled rectifier and AC voltage controller.
- Force Commutation:** Here external component bring anode current to zero forcefully.
Example: Chopper and inverter.

Types of Force Commutation Circuit

(a) Class A (Load Commutation):

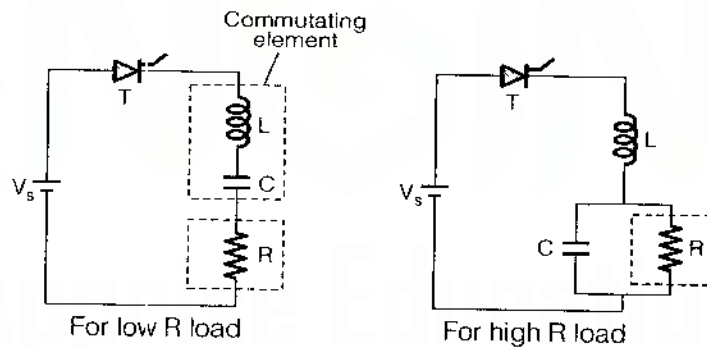

Over all circuit must be underdamped.

i.e.

$$R^2 < \frac{4L}{C}$$

- This type of commutation is possible in dc circuit not in ac circuit.
- Load commutation is also called resonant commutation or self commutation.

(b) Class B Commutation:

It is also called as current commutation or resonant pulse commutation.
Assumption:

- Load current is assumed constant.
- The capacitor is initially charged with V_s volt with left plate positive and right plate negative.

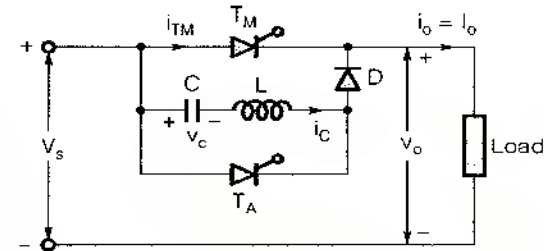

Here,

T_A = Auxiliary thyristor and
 T_M = Main thyristor

- Commutation process is initiated by switching ON the auxiliary thyristor.

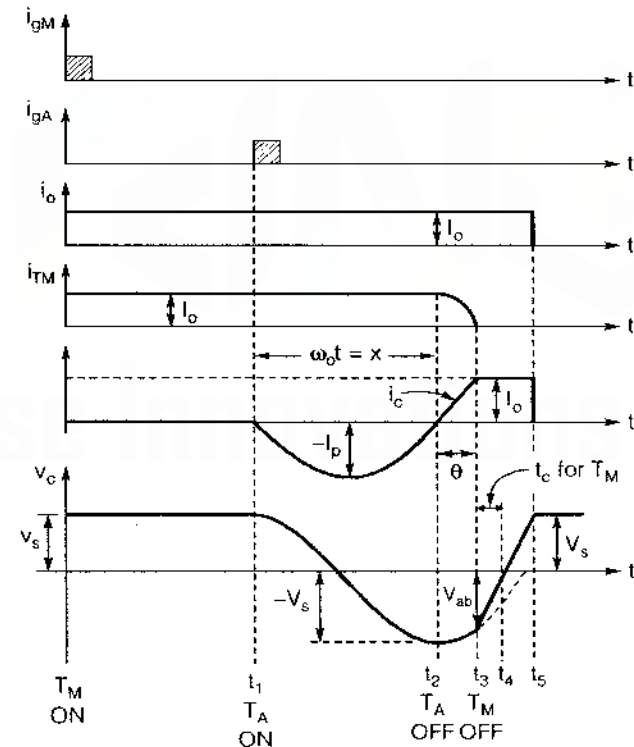

Resonant current

$$i_c = -V_s \sqrt{\frac{C}{L}} \sin \omega_o t = -I_p \sin \omega_o t$$

Peak resonant current

$$I_p = V_s \sqrt{\frac{C}{L}}$$

Circuit turn-off time for main thyristor (T_m)

$$t_c = C \frac{V_{ab}}{I_o}$$

Reverse voltage across main thyristor

$$V_{ab} = V_s \cos \left[\sin^{-1} \left(\frac{I_o}{I_p} \right) \right]$$

Conduction time of auxiliary thyristor = $\pi \sqrt{LC}$

(c) Class C Commutation:

It is also called, complementary impulse commutation.

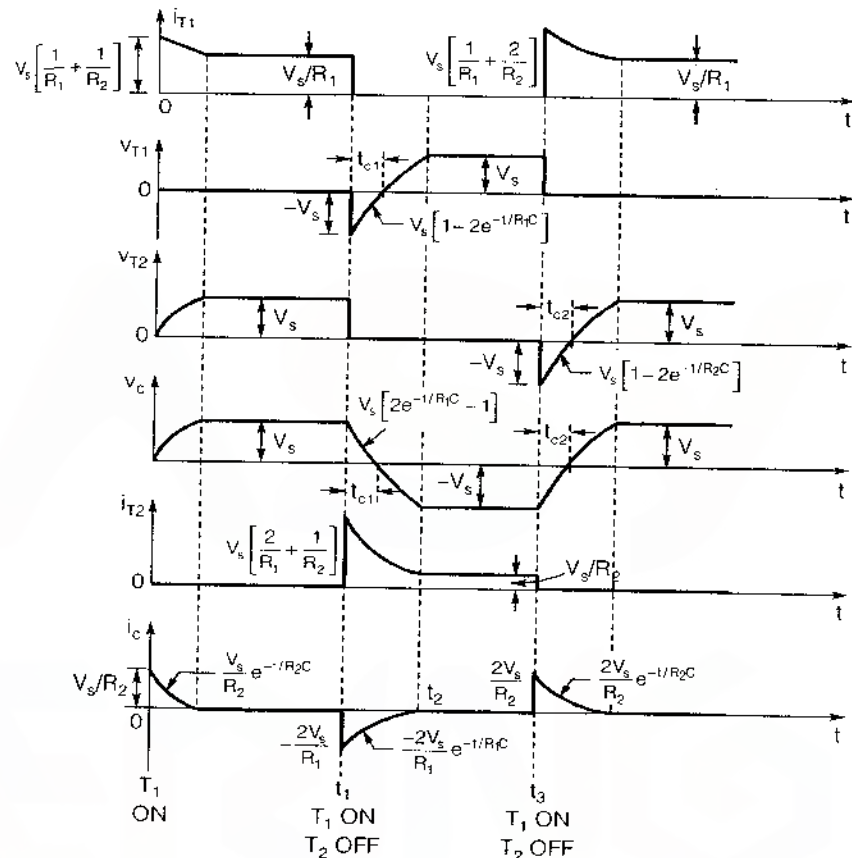
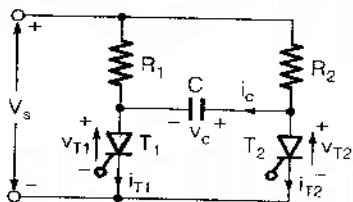

Case-1: When T_1 is turned ON at $t = 0$, T_2 is off

The charging current (when capacitor is initially uncharged)

$$i_c = \frac{V_s}{R_2} e^{-t/R_2 C}$$

Voltage across capacitor C

$$v_c(t) = V_s (1 - e^{-t/R_2 C})$$

Case-2: When T_1 is to be turned OFF, T_2 is turned ON at t_1

□ The charging current

$$i_c(t) = -\frac{2V_s}{R_1} e^{-t/R_1C}$$

□ Voltage across capacitor C

$$V_c(t) = V_s \cdot [2e^{-t/R_1C} - 1]$$

Note: In last equation, time is measured from the instant t_1 .

□ Peak current through T_1

$$I_{T_1,P} = V_s \left[\frac{1}{R_1} + \frac{2}{R_2} \right]$$

□ Peak current through T_2

$$I_{T_2,P} = V_s \left[\frac{2}{R_1} + \frac{1}{R_2} \right]$$

□ Circuit turn-off time for T_1

$$t_{c1} = R_1C \ln(2)$$

□ Circuit turn-off time for T_2

$$t_{c2} = R_2C \ln(2)$$

(d) Class D Commutation:

Also known as:

1. Impulse commutation
2. Voltage commutation
3. Auxiliary commutation
4. Parallel-capacitor commutation

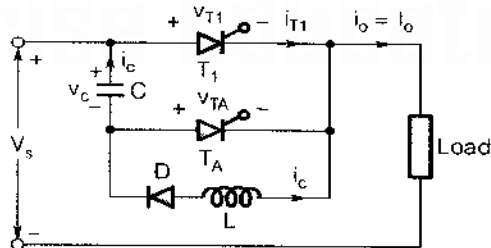

where,

T_1 = Main thyristor

T_A = Auxiliary thyristor

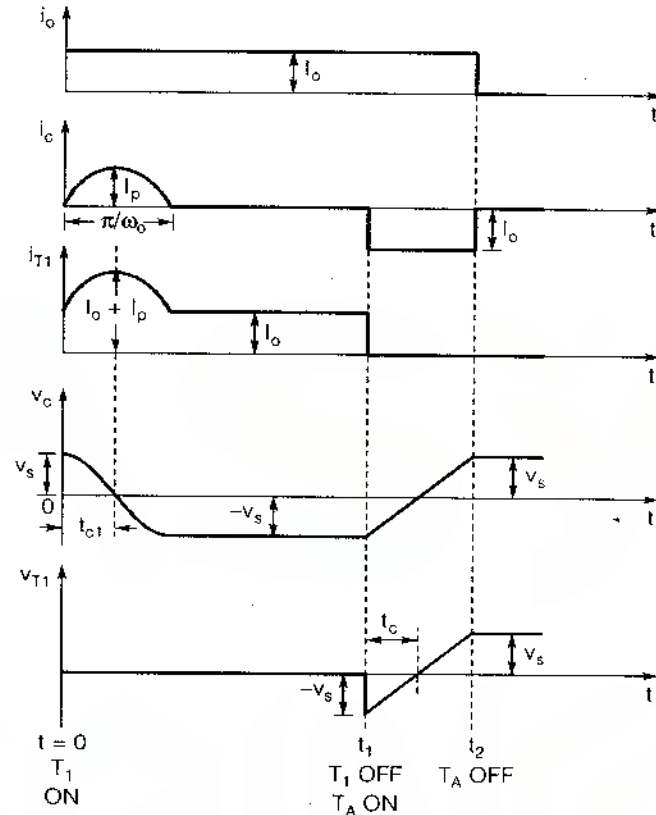

Assumption:

1. Load current is assumed constant.
2. The capacitor is initially charged to V_s as shown in figure.

□ Capacitor current

$$i_c = I_p \sin \omega_o t$$

$$I_p = V_s \sqrt{\frac{C}{L}} \sin \omega_o t$$

□ Peak value of current through capacitor

$$I_p = V_s \sqrt{\frac{C}{L}}$$

- Peak value of current through main thyristor (T_1)

$$(I_p)_{T_1} = I_p + I_o$$

- Peak value of current through auxiliary thyristor (T_A) = I_o
- Circuit turn-off time for main thyristor (T_1)

$$t_c = C \frac{V_s}{I_o}$$

- Circuit turn-off time for auxiliary thyristor (T_A)

$$t_{c1} = \frac{\pi}{2\omega_o} = \frac{\pi}{2} \sqrt{LC}$$



Phase Controlled Rectifiers

5

Uncontrolled rectifier use diode and it convert fixed ac to fixed dc but controlled rectifier use SCR and it convert fixed ac to variable dc. By changing firing angle α , output also changes.

In all phase controlled rectifier natural commutation take place.

Single Phase Half Wave Rectifier

It is also called as one pulse converter because for one cycle of supply voltage we get one pulse at output voltage.

(a) With R load:

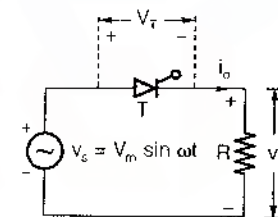

From: 0 to α T → OFF
 α to π T → ON

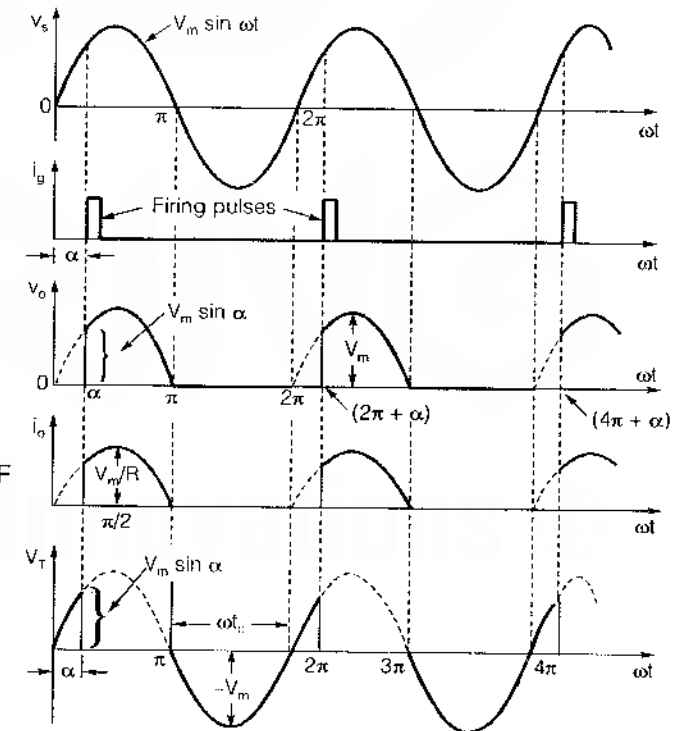

□ Average load voltage

$$V_o = \frac{V_m}{2\pi} (1 + \cos \alpha)$$

where, α = Firing angle

V_m = Maximum value of sinusoidal source voltage

□ RMS value of load voltage

$$V_{or} = \frac{V_m}{2\sqrt{\pi}} \left[(\pi - \alpha) + \frac{1}{2} \sin 2\alpha \right]^{1/2}$$

□ RMS current

$$I_{or} = \frac{V_{or}}{R}$$

□ Power dissipated in R load

$$P = V_{or} I_{or} = I_{or}^2 R = \frac{V_{or}^2}{R}$$

□ Input power factor

$$\text{p.f.} = \frac{\text{Power delivered to load}}{\text{Input VA}}$$

$$\text{p.f.} = \frac{V_{or}}{V_s}$$

□ Circuit turn-off time

$$t_c = \frac{\pi}{\omega} \text{ sec.}$$

Remember:

- Circuit turn-off time must be more than the SCR turn-off time for satisfactory commutation.
- The source current introduces DC component in the supply transformer and saturate the transformer. This is disadvantage of 1ϕ -half wave rectifier.

(b) RL Load:

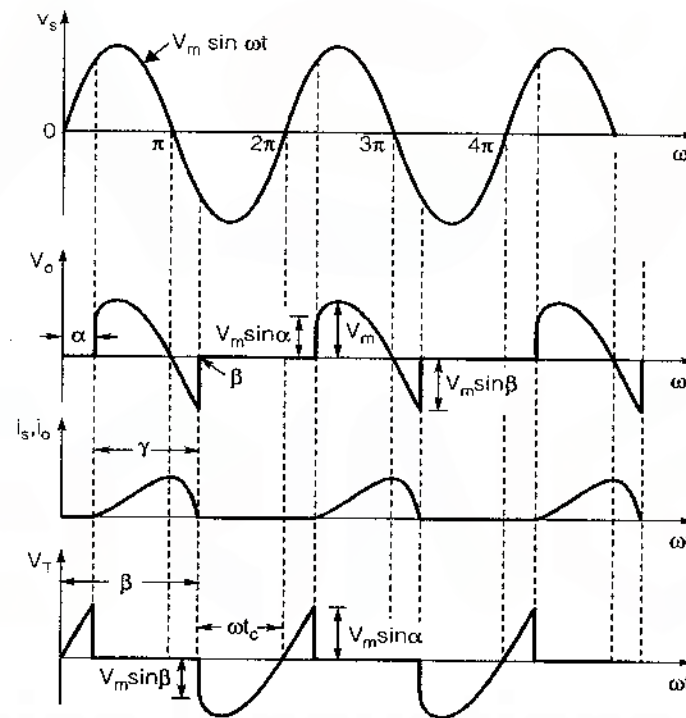
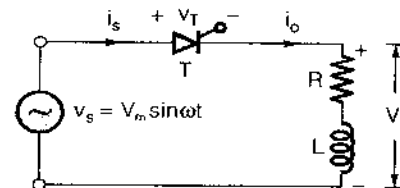

□ Average load voltage

$$V_o = \frac{V_m}{2\pi} (\cos \alpha - \cos \beta)$$

□ Rms load voltage

$$V_{or} = \frac{V_m}{2\sqrt{\pi}} \left[(\beta - \alpha) - \frac{1}{2} \{ \sin 2\beta - \sin 2\alpha \} \right]^{1/2}$$

where, β = Extinction angle

□ Conduction angle

$$\gamma = \beta - \alpha$$

□ Circuit turn-off time

$$t_c = \frac{2\pi - \beta}{\omega}$$

Remember:

- From $\omega t = \pi$ to β , thyristor is forced to conduct in negative supply by the stored energy in the inductor, here energy is fed back to source.
- At $\omega t = \beta$, inductor fed back its whole energy to source.

(c) RL Load with Freewheeling Diode:

The performance of converter is improve by connecting a free wheeling diode across the load.

Advantage of freewheeling diode:

- Power factor improve.
- Negative spikes in output voltage are removed.
- The overall current waveform is improved.
- Overall converter efficiency improves.

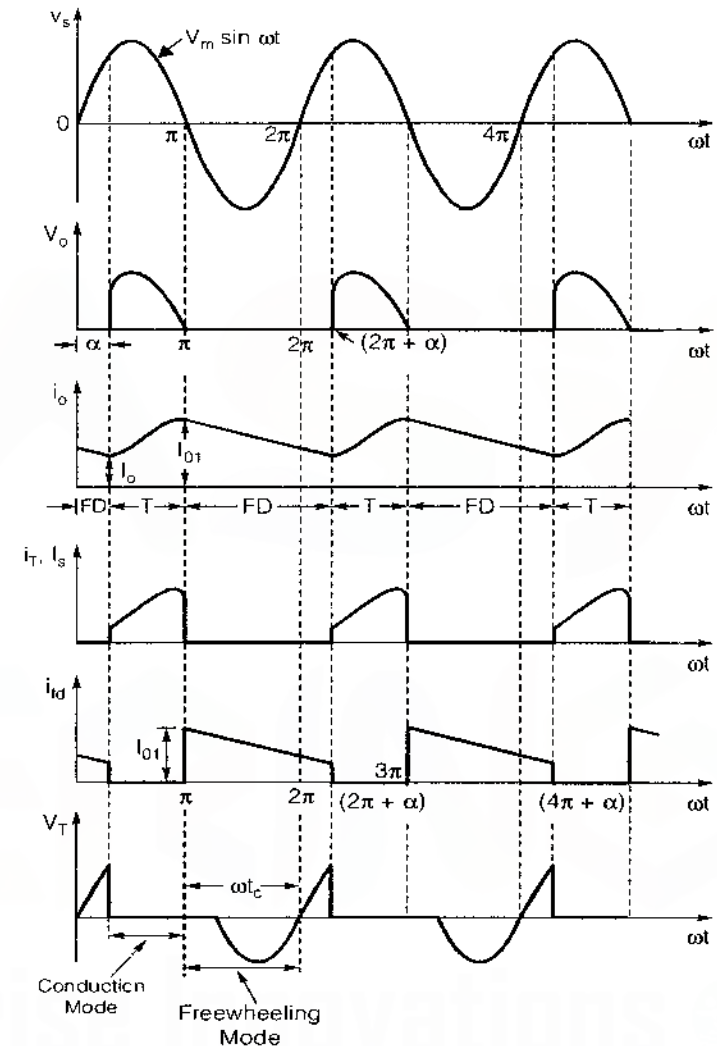
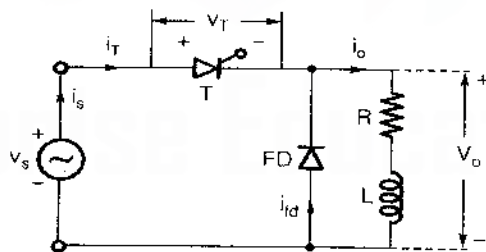

□ The average output voltage

$$V_o = \frac{V_m}{2\pi} [1 + \cos \alpha]$$

- The average output current

$$I_o = \frac{V_m}{2\pi R} [1 + \cos \alpha]$$

- The RMS output voltage

$$V_{or} = \frac{V_m}{2\sqrt{\pi}} \left[(\pi - \alpha) + \frac{1}{2} \sin 2\alpha \right]^{1/2}$$

- Circuit turn-off time

$$t_c = \frac{\pi}{\omega} \text{ sec}$$

(d) RE Load or Charging Battery

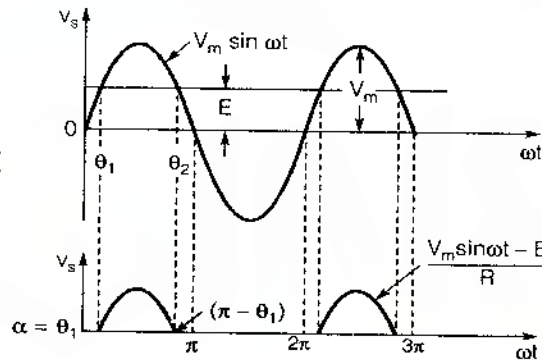
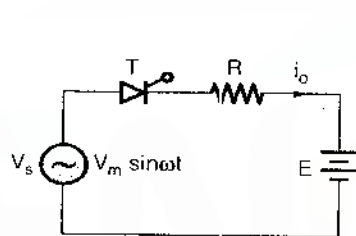

- Charging current

$$i_o = \frac{V_m \sin \omega t - E}{R}$$

- Minimum value of firing angle

$$\theta_1 = \sin^{-1} \left(\frac{E}{V_m} \right)$$

- Maximum value of firing angle

$$\theta_2 = \pi - \theta_1$$

- Range of firing angle

$$\theta_1 \leq \alpha \leq \theta_2$$

- Conduction angle of thyristor

$$\gamma = \theta_2 - \alpha$$

- Circuit turn-off time of thyristor

$$t_c = \frac{2\pi + \theta_1 - \theta_2}{\omega} = \frac{\pi + 2\theta_1}{\omega}$$

- Average output voltage:

$$V_o = \frac{1}{2\pi} [V_m (\cos \alpha - \cos \theta_2) + E(2\pi + \alpha - \theta_2)]$$

- Average charging current of battery

$$I_o = \frac{1}{2\pi R} [V_m (\cos \alpha - \cos \theta_2) - E(\theta_2 - \alpha)]$$

- Power supplied by battery = $E I_o$

Remember:

When continuous gate signal is given to SCR, it behaves like diode.
.....

(e) RLE Load or DC Machine Load

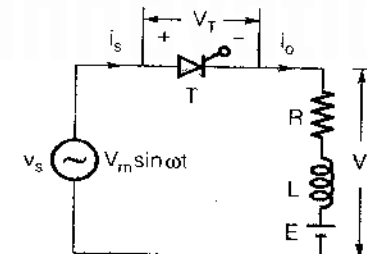

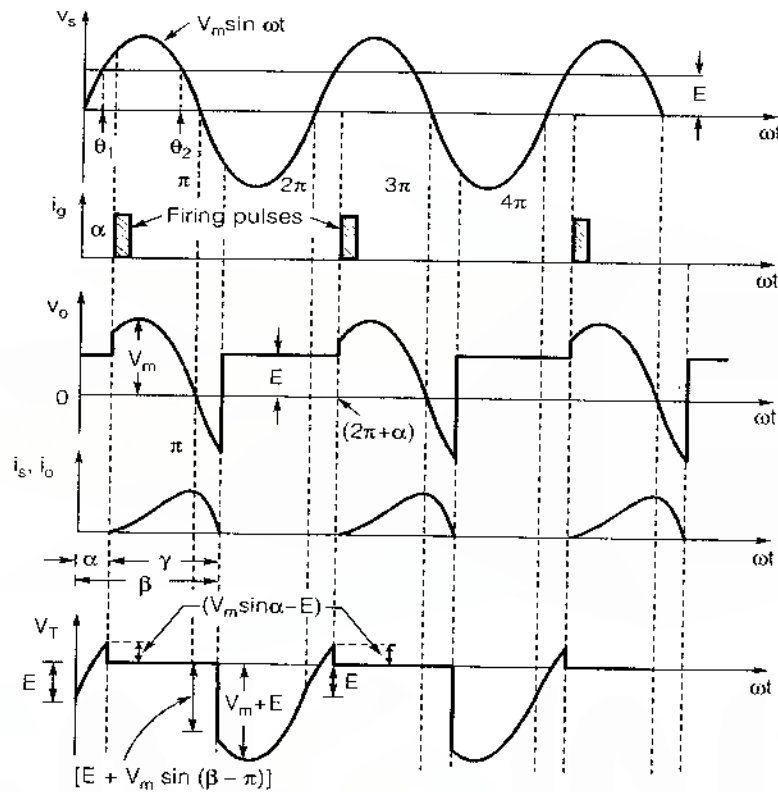

- Minimum value of firing angle

$$\theta_1 = \sin^{-1}\left(\frac{E}{V_m}\right)$$

- Maximum value of firing angle, $\theta_2 = (\pi - \theta_1)$
- Average load current

$$I_o = \frac{1}{2\pi R} [V_m (\cos \alpha + \cos \beta) - E(\beta - \alpha)]$$

- Average load voltage

$$V_o = E \left(1 - \frac{\gamma}{2\pi}\right) + \frac{V_m}{\pi} \sin\left(\alpha + \frac{\gamma}{2}\right) \cdot \sin\frac{\gamma}{2}$$

$$V_o = \frac{1}{2\pi} [V_m (\cos \alpha - \cos \beta) + E(2\pi + \alpha - \beta)]$$

or

- Maximum reverse voltage to thyristor = $(V_m + E)$
- Circuit turn-off time

$$t_c = \frac{2\pi - \beta}{\omega} \text{ sec}$$

- RMS load current

$$I_{or} = \left[\frac{1}{2\pi R^2} \left\{ (E^2 + V_s^2) (\pi - 2\alpha) + V_s^2 \sin 2\alpha - 4V_m E \cos \alpha \right\} \right]^{1/2}$$

- Power delivered to load

$$P = I_{or}^2 R + I_o E$$

- Power factor

$$PF = \frac{I_{or}^2 R + I_o E}{V_s I_{or}}$$

Remember:

High value of inductance results in continuous conduction.

Single Phase Full-wave Converter

Full-wave rectifier is 2 pulse rectifier, for one cycle of voltage wave we get 2 pulse of current wave.

It has two configuration:

- Mid point converter
- Bridge converter

Remember:

- SCRs are subjected to a peak inverse voltage of $2V_m$ in mid point converter and V_m in bridge converter.
- Mid point configuration is used in case, the terminals on D.C. side have to be grounded.
- Bridge configuration is preferred over midpoint configuration.

(a) RL Load

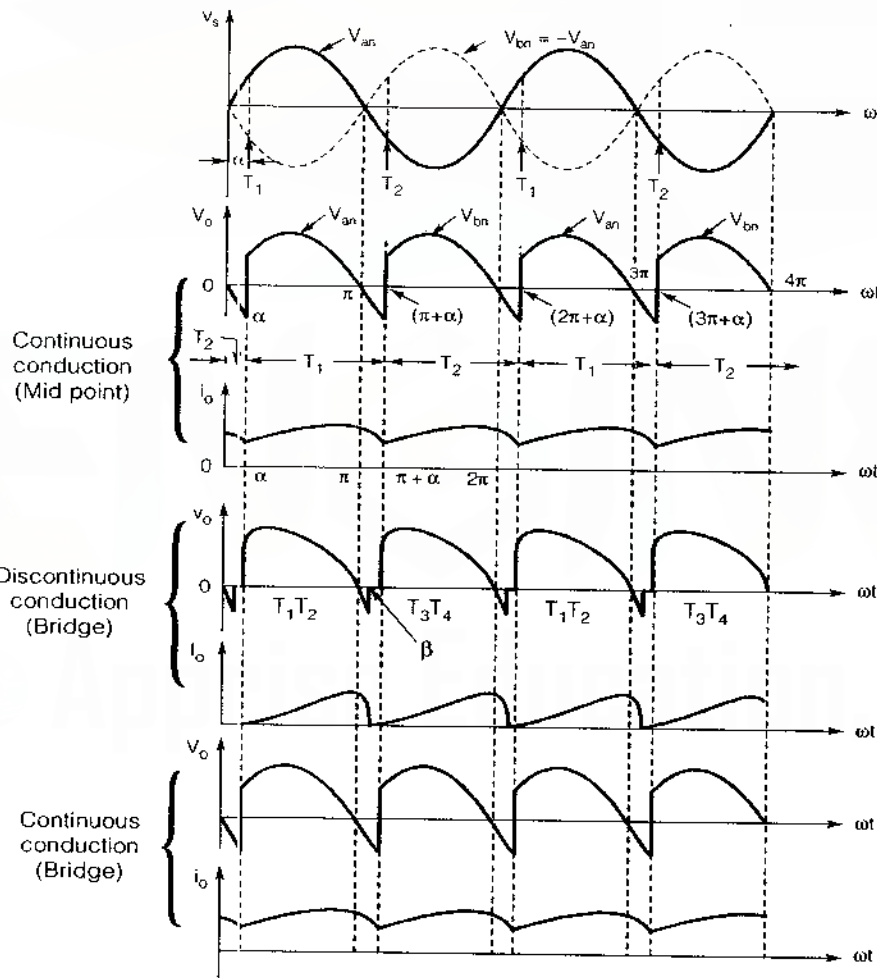
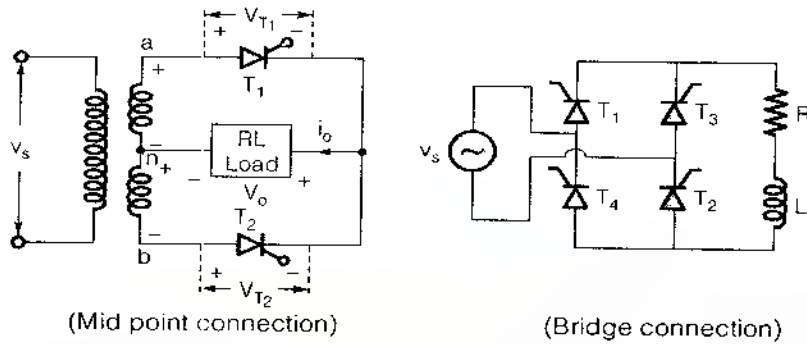

(i) Discontinuous conduction:

- Average output voltage

$$V_o = \frac{V_m}{\pi} [\cos \alpha - \cos \beta]$$

- RMS output voltage

$$V_{or} = \frac{V_m}{\sqrt{2\pi}} \left[(\beta - \alpha) + \frac{1}{2} (\sin 2\alpha - \sin 2\beta) \right]^{1/2}$$

- Power factor

$$\cos \phi = \frac{V_{or}}{V_{sr}}$$

- Circuit turn-off time (t_c)

$$t_c = \frac{2\pi - \beta}{\omega}$$

(ii) Continuous conduction:

- Average output voltage

$$V_o = \frac{2V_m}{\pi} \cos \alpha$$

- RMS output voltage

$$V_{or} = \frac{V_m}{\sqrt{2}}$$

- Circuit turn-off time

$$t_c = \frac{\pi + \alpha}{\omega}$$

Single Phase Semiconverter

Semiconductor also known as half-controlled rectifier or 2 pulse converter.

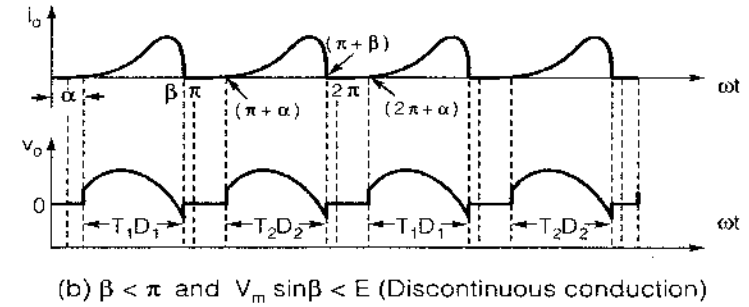
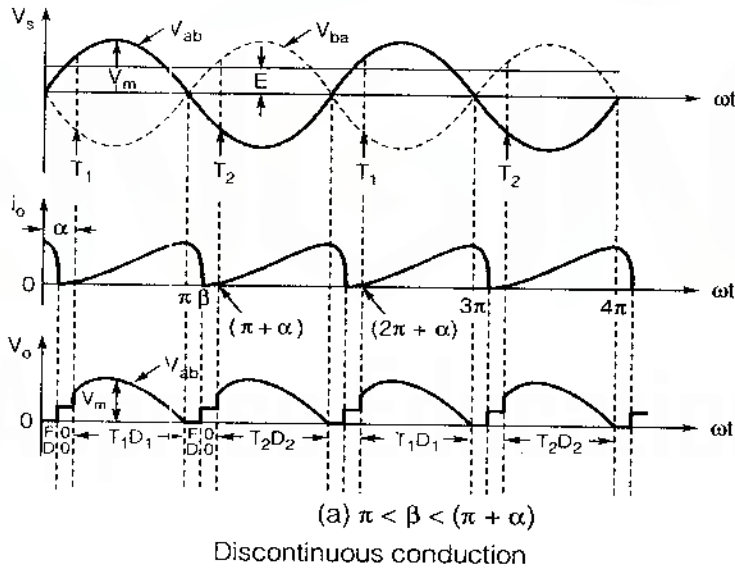
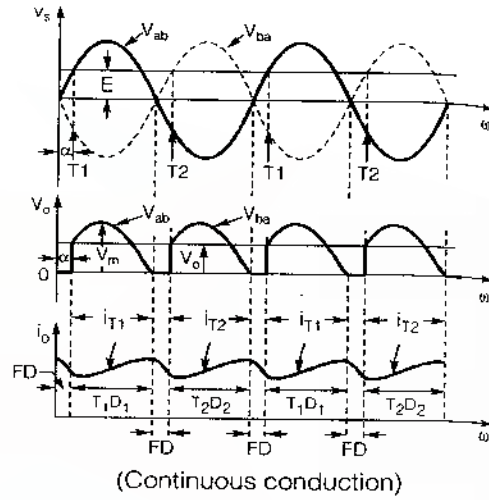
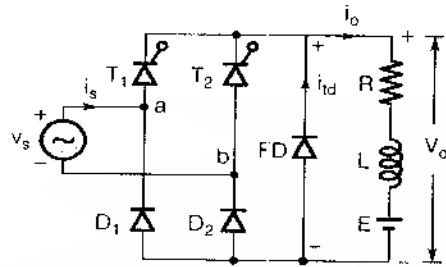

(i) **Continuous conduction:**

□ Average output voltage

$$V_o = \frac{V_m}{\pi} (1 + \cos \alpha)$$

□ RMS output voltage

$$V_{or} = \frac{V_m}{\sqrt{2}\pi} \left\{ (\pi - \alpha) + \frac{1}{2} \sin 2\alpha \right\}^{1/2}$$

□ Circuit turn-off time

$$t_c = \frac{\pi - \alpha}{\omega}$$

(without freewheeling diode)

$$t_c = \frac{\pi}{\omega}$$

(with free wheeling diode)

(ii) **Discontinuous conduction**

□ Average output voltage

$$V_o = \frac{1}{\pi} [V_m(1 + \cos \alpha) + E(\pi + \alpha - \beta)]$$

Note:

- For $\beta < \pi$, freewheeling diode does not conduct.
- Freewheeling diode prevents the occurrence of dead short circuit of source.
- Single phase full converter is two quadrant converter and single phase semiconverter is one quadrant converter.

3 ϕ Half-Wave Controlled Converter

- It is a 3-pulse converter

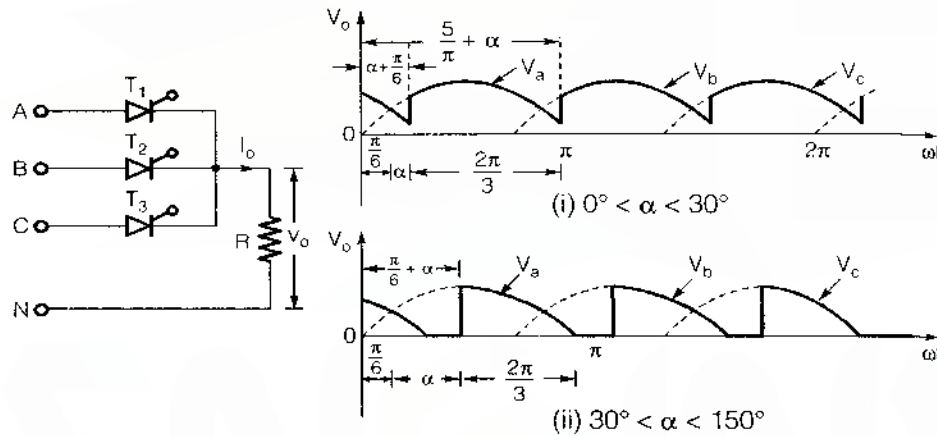

when,

$$\alpha \leq \frac{\pi}{6} \text{ continuous conduction}$$

$$\alpha > \frac{\pi}{6} \text{ discontinuous conduction}$$

(a) R Load

Case-1: when $\alpha < 30^\circ$

- Average output voltage

$$V_0 = \frac{3\sqrt{3}}{2\pi} V_{mp} \cos \alpha = \frac{3V_{ml}}{2\pi} \cos \alpha$$

- RMS value of output voltage

$$V_{or} = V_{ml} \left[\frac{1}{6} + \frac{\sqrt{3}}{8\pi} \cos 2\alpha \right]^{1/2}$$

Both formula valid for

- (i) R load when $\alpha < 30^\circ$.
- (ii) RL load for any value of α .

where V_{mp} = Maximum value of phase voltage

$$V_{ml} = \sqrt{3} V_{mp} = \text{Maximum value of line voltage}$$

Case-2: when $\alpha > 30^\circ$

- Average output voltage

$$V_0 = \frac{3V_{mp}}{2\pi} \left[1 + \cos \left(\alpha + \frac{\pi}{6} \right) \right]$$

- RMS value of output voltage

$$V_{or} = \frac{V_{ml}}{2\sqrt{\pi}} \left[\left(\frac{5\pi}{6} - \alpha \right) + \frac{1}{2} \sin \left(2\alpha + \frac{\pi}{3} \right) \right]^{1/2}$$

Both formula valid for

- (i) R load when $\alpha > 30^\circ$.
- (ii) RL load with freewheeling diode when $\alpha > \pi/6$.
- (iii) RLE load with F.D. when $\alpha > \pi/6$.

3 ϕ -Full converter

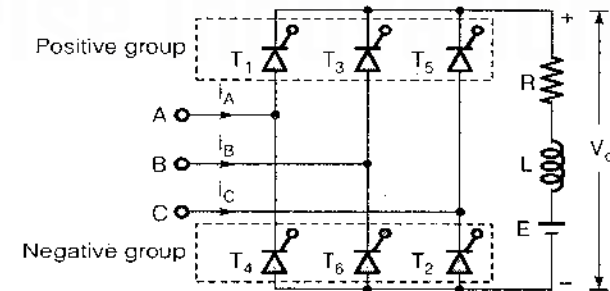

6 Pulse Converter

Positive group of SCR fired at an interval of 120°, similarly negative group of SCR are fired with an interval of 120° amongst them. But SCR from both the group are fired at an interval of 60°. At any time two SCRs, one from positive group and other from negative group must conduct together.

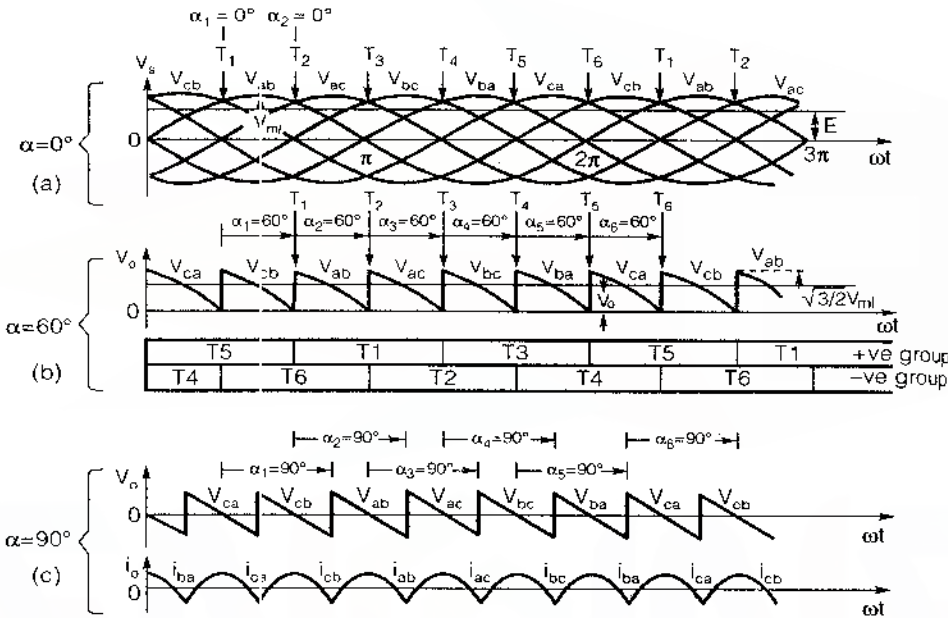

For R Load

Case 1: when $\alpha \leq 60^\circ$

□ Average output voltage

$$V_o = \frac{3V_{ml}}{\pi} \cos \alpha$$

□ RMS output voltage

$$V_{or} = \sqrt{\frac{3}{2\pi} V_{ml} \left[\frac{\pi}{3} + \frac{\sqrt{3}}{2} \cos 2\alpha \right]^{1/2}}$$

Above formulae valid for

- (i) R load when $\alpha \leq 60^\circ$.
- (ii) RL and RLE load any value of α .

Case 2: when $\alpha > 60^\circ$

Average output voltage

$$V_o = \frac{3V_{ml}}{\pi} \left[1 + \cos \left(\alpha + \frac{\pi}{3} \right) \right]$$

Note:

Formula valid for R load $\alpha > 60^\circ$ and for RL, RLE load with FD.

3 ϕ Half Controlled Rectifier (or) 3 ϕ Semiconverter

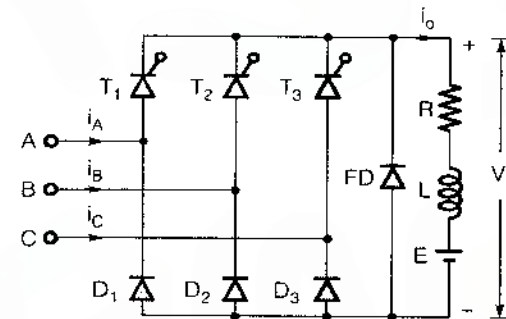

For

$$\alpha < 60^\circ = 6 \text{ pulse}$$

$$\alpha \geq 60^\circ = 3 \text{ pulse}$$

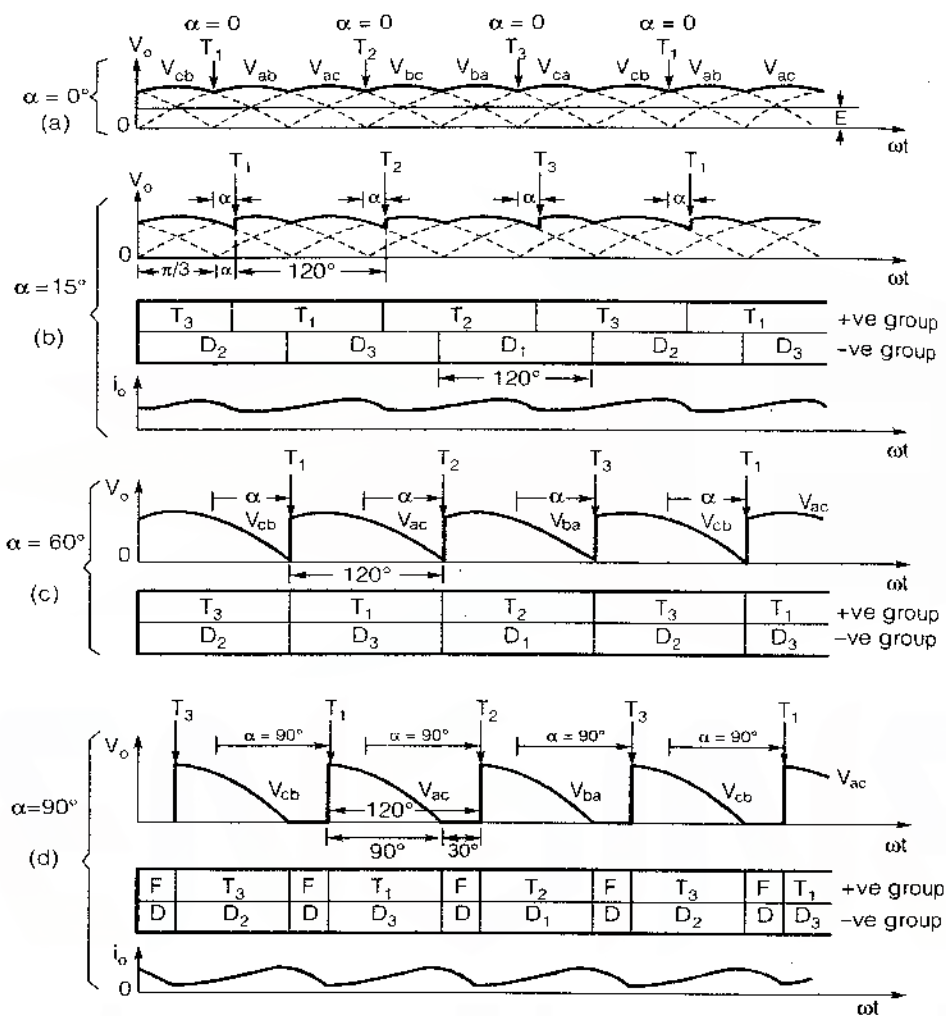

Case-1: when $\alpha < 60^\circ$

□ Average output voltage

$$V_o = \frac{3V_{mL}}{2\pi} (1 + \cos \alpha)$$

□ RMS value of output voltage

$$V_{or} = \frac{V_{mL}}{2} \sqrt{\frac{3}{\pi} \left[\frac{2\pi}{3} + \frac{\sqrt{3}}{2} (1 + \cos 2\alpha) \right]^{1/2}}$$

Case-2: when $\alpha \geq 60^\circ$

□ Average output voltage

$$V_o = \frac{3V_{mL}}{2\pi} (1 + \cos \alpha)$$

□ RMS value of output voltage

$$V_{or} = \frac{V_{mL}}{2} \sqrt{\frac{3}{\pi} \left[(\pi - \alpha) + \frac{1}{2} \sin 2\alpha \right]^{1/2}}$$

Remember:

- For $\alpha \leq 60^\circ$, freewheeling diode does not conduct.
- 3 ϕ -semiconverter is only one quadrant converter.
- In 3 ϕ -semiconverter, braking mode is not possible.



Choppers

6

A chopper is a high speed on/off semiconductor switch. Chopper is a static device that converts fixed dc input voltage to a variable dc output voltage directly.

Remember:

For medium power application we use IGBT and GTO, in chopper.

Step Down Chopper

Average output voltage V_o is always less than the input voltage V_s .

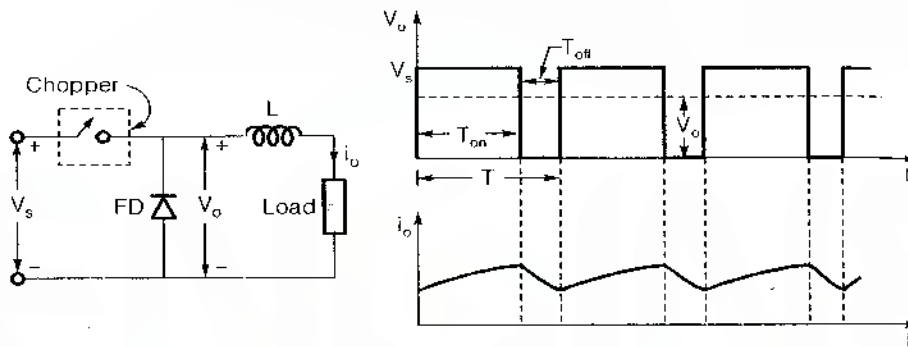

□ Duty cycle

$$\alpha = \frac{T_{ON}}{T} = \frac{T_{ON}}{T_{ON} + T_{OFF}} ; \alpha < 1$$

□ Average load voltage

$$V_o = \alpha V_s$$

□ RMS load voltage

$$V_{RMS} = \sqrt{\alpha} V_s$$

□ Average load current

$$I_o = \frac{V_o}{R} = \frac{\alpha V_s}{R}$$

□ RMS load current

$$I_{RMS} = \frac{\sqrt{\alpha} V_s}{R}$$

Note:

- Above formulae valid only for continuous conduction.
- Inductor connected in series with load is used to reduce the ripple content in output current.

Step Up Chopper

Average output voltage V_o is more than input DC voltage V_s .

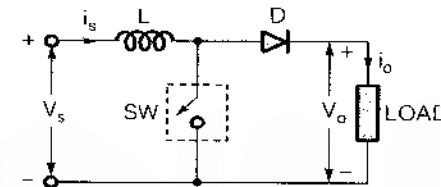

□ Average load voltage

$$V_o = \frac{1}{1-\alpha} V_s$$

- For a basic DC to DC converter, the critical inductance of the filter circuit is given by

$$L = \frac{V_o^2 (V_s - V_o)}{2f V_s P_o}$$

- where, V_o = Load voltage
 V_s = Source voltage
 P_o = Load power
 f = Chopping frequency

Steady State Time-Domain Analysis of Type-A Chopper

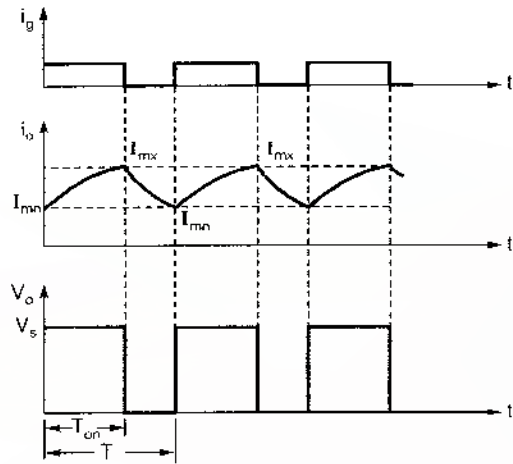

Maximum value of current

$$I_{mx} = \frac{V_s}{R} \left[\frac{1 - e^{-T_{on}/T_a}}{1 - e^{-T/T_a}} \right] - \frac{E}{R}$$

Minimum value of current

$$I_{mn} = \frac{V_s}{R} \left[\frac{e^{T_{on}/T_a} - 1}{e^{T/T_a} - 1} \right] - \frac{E}{R}$$

where, $T_a = \frac{L}{R}$

Per unit ripple current

$$\text{p.u. ripple current} = \frac{(I_{mx} - I_{mn})}{V_s/R} = \frac{(1 - e^{-\alpha T/T_a})(1 - e^{-(1-\alpha)T/T_a})}{(1 - e^{-T/T_a})}$$

Note: The peak to peak ripple current has maximum value ΔI_{mx} when duty cycle $\alpha = 0.5$.

For $\alpha = 0.5$

$$\Delta I_{mx} = \frac{V_s}{R} \tanh \frac{R}{4fL}$$

If $4fL \gg R$ then $\tanh \frac{R}{4fL} \approx \frac{R}{4fL}$

$$\Delta I_{mx} = \frac{V_s}{4fL}$$

Remember:

Higher the inductance, ripple is minimum.

The value of duty cycle at the limit of continuous conduction

$$\alpha' \geq \frac{T_a}{T} \ln \left[1 + \frac{E}{V_s} (e^{T/T_a} - 1) \right]$$

where, α' measures the limit of continuous conduction.

Load Current Discontinuous

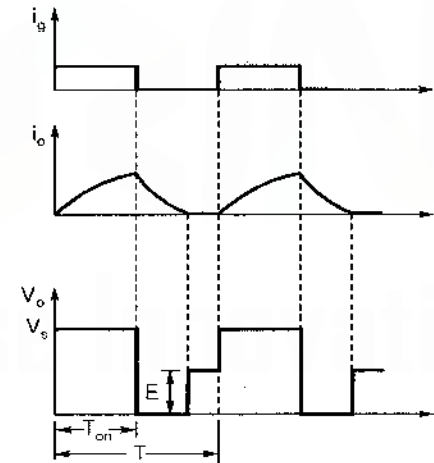

Minimum value of current

$$I_{mn} = 0$$

- Maximum value of current

$$I_{mx} = \frac{V_s - E}{R} (1 - e^{-T_{on}/T_a})$$

- Extinction time (t_x)

$$t_x = T_{on} + T_a \ln \left[1 + \frac{V_s - E}{E} (1 - e^{-T_{on}/T_a}) \right]$$

- Average output voltage

$$V_o = \alpha V_s + \left(1 - \frac{t_x}{T}\right) E$$



Inverters

An inverter is a circuit which converts a dc power into an ac power at desired output voltage and frequency.

Note:

For low and medium power output, we use BJTs, MOSFET, IGBT, GTO. But for high power output, thyristor should be used.

Types of Inverter

1. Voltage Source Inverter (VSI)

VSI is one in which dc source has small impedance. Because of a low internal impedance, the terminal voltage of a voltage source inverter remains substantially constant with variation in load.

2. Current Source Inverter (CSI)

Current source inverter is supplied with a controlled current from a dc source of high impedance. Typically, a phase controlled thyristor rectifier feeds the inverter with a regulated current through a large series inductor. Thus, load current is controlled.

Remember:

- CSI does not required any feedback diodes whereas, these are required in a VSI.
- To make input current almost ripple free ,L-filter is used before CSI.
- CSI may be load or force commutated. Load commutation is possible when load p.f. is leading. For lagging p.f. loads, force commutation is essential.

Single Phase Bridge Inverter

1. Single-Phase Half Bridge Inverter

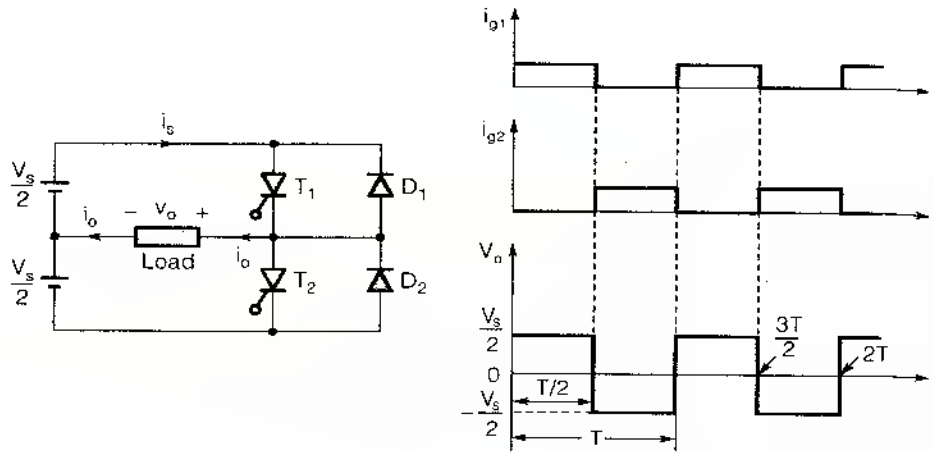

For R load

- RMS output voltage

$$V_{or} = \frac{V_s}{2}$$

- nth harmonic output voltage

$$V_{on} = \frac{2V_s \sin n\omega t}{n\pi}$$

- nth harmonic current

$$I_{on} = \frac{2V_s \sin n\omega t}{n\pi R}$$

- Fundamental output voltage

$$V_{o1} = \frac{2V_s \sin \omega t}{\pi}$$

- RMS fundamental output voltage

$$(V_{o1})_{RMS} = \frac{\sqrt{2} V_s}{\pi}$$

- Fundamental distortion factor (FDF)

$$g = \frac{(V_{o1})_{RMS}}{V_{or}} = \frac{2\sqrt{2}}{\pi}$$

- Total harmonic distortion (THD)

$$THD = \left(\frac{1}{g^2} - 1 \right)^{1/2}$$

$$THD = 48.34\%$$

2. Single Phase-Full Bridge Inverter

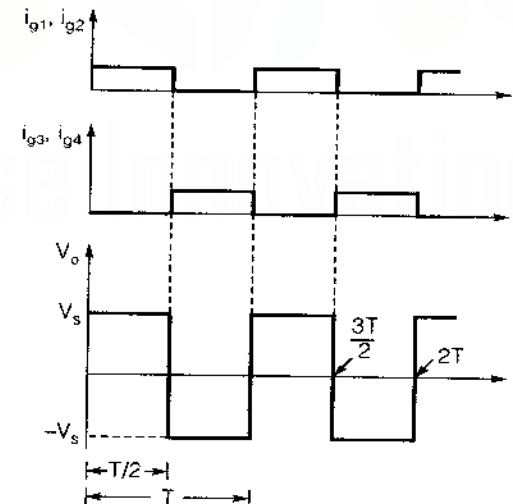
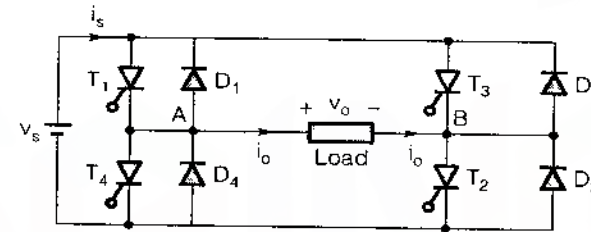

For R load

- RMS output voltage

$$V_{or} = V_s$$

- nth harmonic output voltage

$$V_{on} = \frac{4V_s}{n\pi} \sin n\omega t$$

- Fundamental output voltage

$$V_{o1} = \frac{4V_s}{\pi} \sin \omega t$$

- RMS fundamental output voltage

$$(V_{o1})_{RMS} = \frac{2\sqrt{2}}{\pi} V_s$$

- Fundamental distortion factor (FDF)

$$g = \frac{2\sqrt{2}}{\pi}$$

- Total harmonic distortion (THD)

$$THD = 48.34\%$$

Single Phase VSI for Different Loads

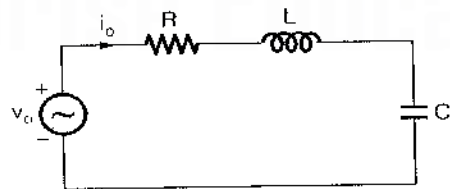

(a)

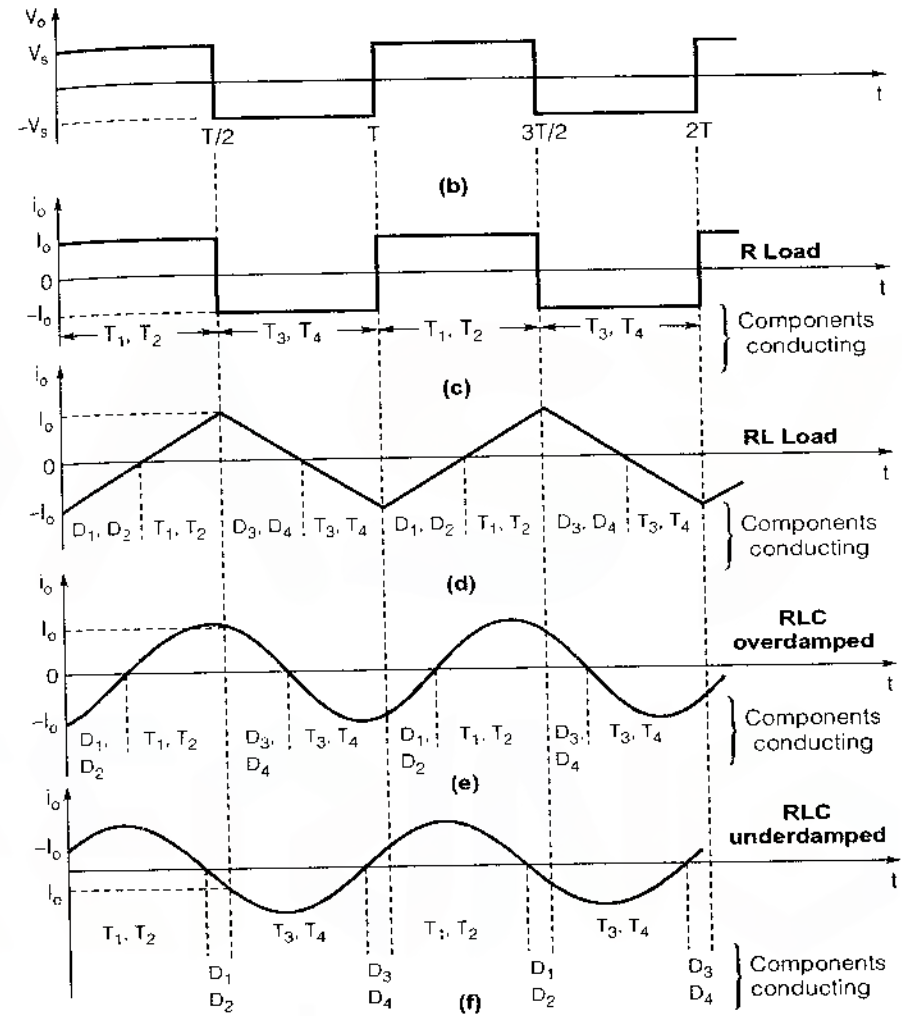

- Load impedance at frequency (nf)

$$Z_n = \left[R^2 + \left(n\omega L - \frac{1}{n\omega C} \right)^2 \right]^{1/2}$$

- Phase angle

$$\phi_n = \tan^{-1} \left[\frac{n\omega L - \frac{1}{n\omega C}}{R} \right] \text{ rad}$$

Output current at the instant of commutation

$$I_o = \frac{V_o}{Z_n} \quad \omega t = \pi$$

Fundamental load power

$$P_{o1} = I_{o1}^2 R = V_{o1} I_{o1} \cos \theta_1$$

where, I_{o1} = RMS value of fundamental output current
 V_{o1} = RMS value of fundamental output voltage

Note:

- If circuit turn-off time (t_c) is more than device turn-off time (t_q) then it does not require force commutation.
- If $t_q > t_c$ then force commutation required.
- The fundamental output power P_{o1} does the useful work and the output power associated with harmonic current is dissipated as heat, leading to rise in load temperature.
- Feedback diode (D) conducts only when there is presence of energy storing element L and C in load.

Three Phase Bridge Inverter

For providing adjustable frequency power to industrial application, 3 ϕ bridge inverter are used. A large capacitor is connected at the input terminals tend to make the input DC voltage constant.

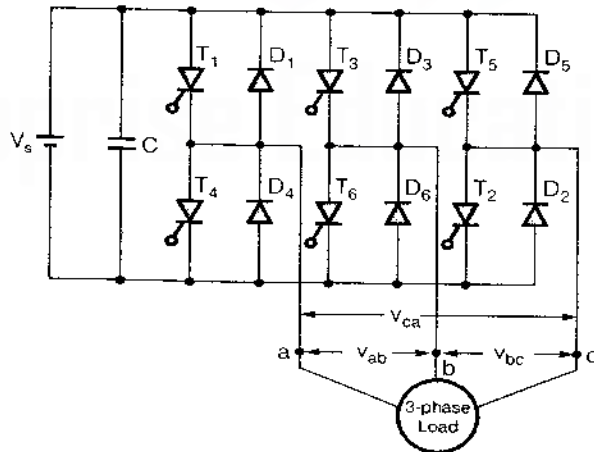

1. 3 ϕ 180° Mode VSI

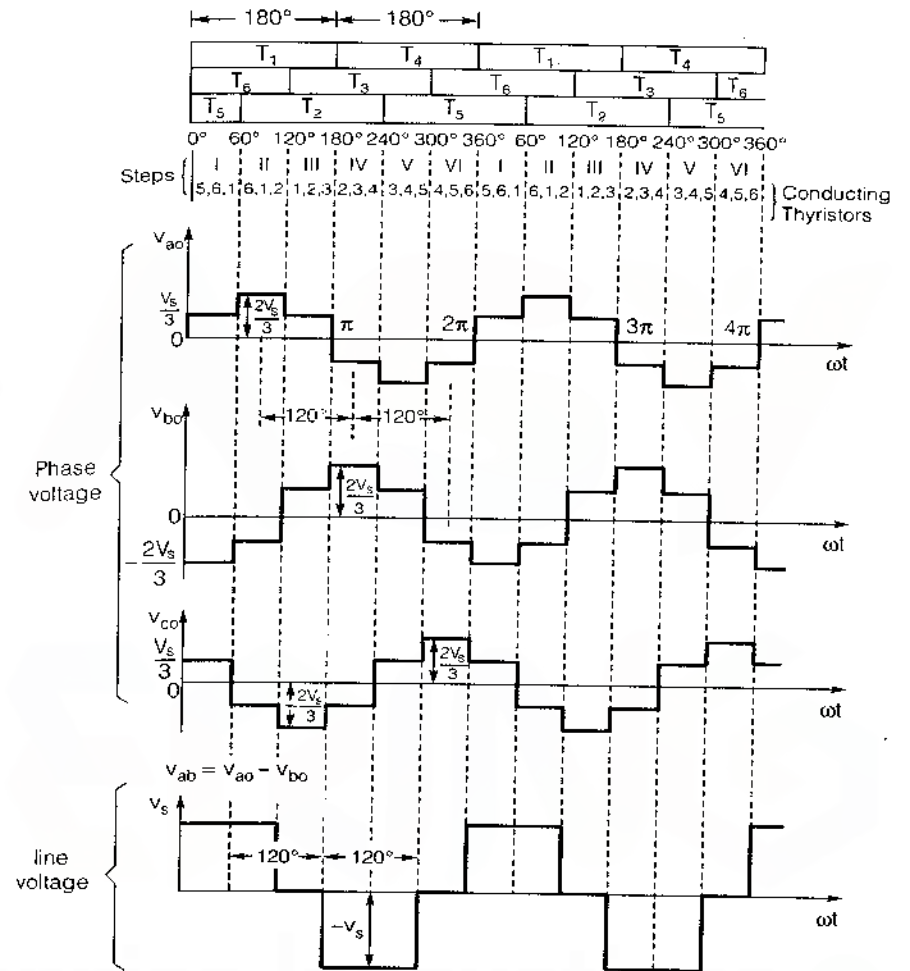

Phase RMS voltage

$$(V_{ph})_{RMS} = \frac{\sqrt{2}}{3} V_s$$

Line RMS voltage

$$(V_L)_{RMS} = \frac{\sqrt{2}}{\sqrt{3}} V_s$$

- n^{th} harmonic output voltage for phase "a"

$$V_{an} = \frac{2V_s}{n\pi} \sin n\omega t$$

- Fundamental phase RMS voltage

$$(V_{a1}) = \frac{\sqrt{2}V_s}{\pi}$$

-

$$\text{FDF (g)} = \frac{3}{\pi}$$

-

$$\text{THD} = 31\%$$

- n^{th} harmonic line output voltage

$$(V_{ab})_n = \frac{4V_s}{n\pi} \cos \frac{n\pi}{6} \sin n\left(\omega t + \frac{\pi}{6}\right)$$

- Fundamental RMS line value

$$(V_{ab})_{\text{RMS}} = \frac{2\sqrt{2}}{\pi} \cos \frac{\pi}{6} = \frac{\sqrt{6}}{\pi} V_s$$

-

$$\text{FDF (g)} = \frac{3}{\pi}$$

-

$$\text{THD} = 31\%$$

Remember:

- The phase as well as line voltage are out of phase by 120° .
- For $n = 3$, all triplen harmonics are absent from the line voltage.

2. 3ϕ 120° Mode VSI

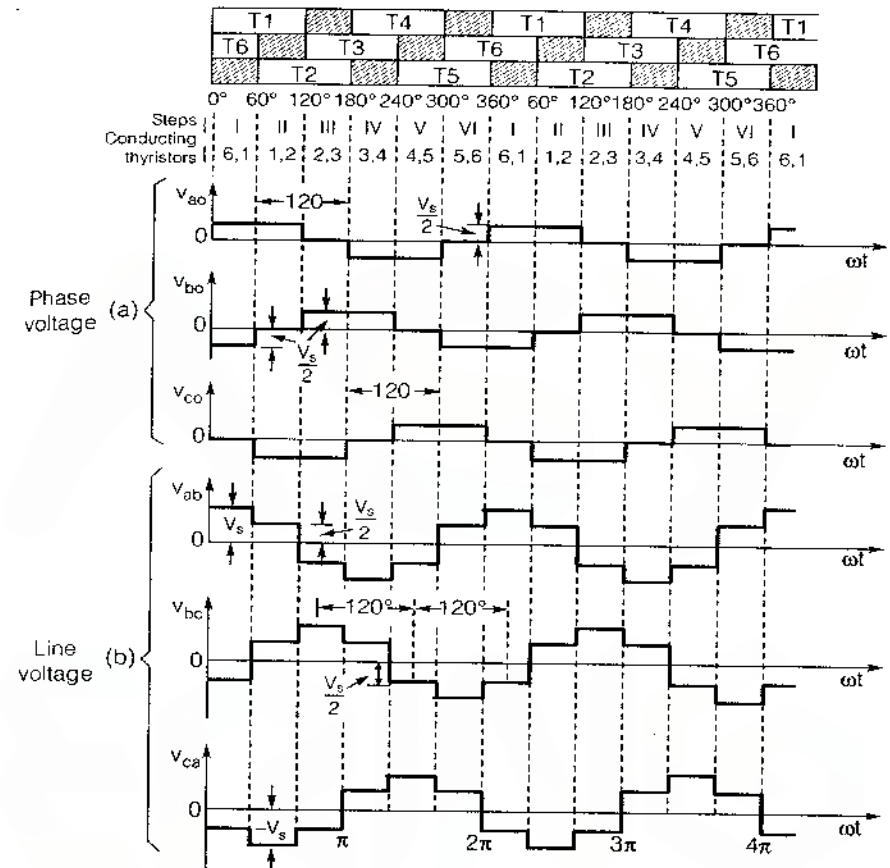

- Line voltage

$$V_{ab} = \sum_{n=6k+1}^{\infty} \frac{3V_s}{n\pi} \sin n\left(\omega t + \frac{\pi}{3}\right)$$

where, $k = 0, 1, 2 \dots$

- Phase voltage

$$V_{a0} = \sum_{n=1,3,5,\dots}^{\infty} \frac{2V_s}{n\pi} \cos \frac{n\pi}{6} \sin n\left(\omega t + \frac{\pi}{6}\right)$$

- RMS value of phase voltage

$$V_p = \frac{V_s}{\sqrt{6}} = 0.4082 V_s$$

- RMS value of line voltage

$$V_L = \frac{V_s}{\sqrt{2}} = 0.7071 V_s$$

For both line and phase voltage:

- FDF = $\frac{3}{\pi}$ and THD = 31%

Remember:

- Generally we used IGBT in 1 ϕ and 3 ϕ inverter.

Pulse Width Modulated Inverters

1. Single-pulse Modulation

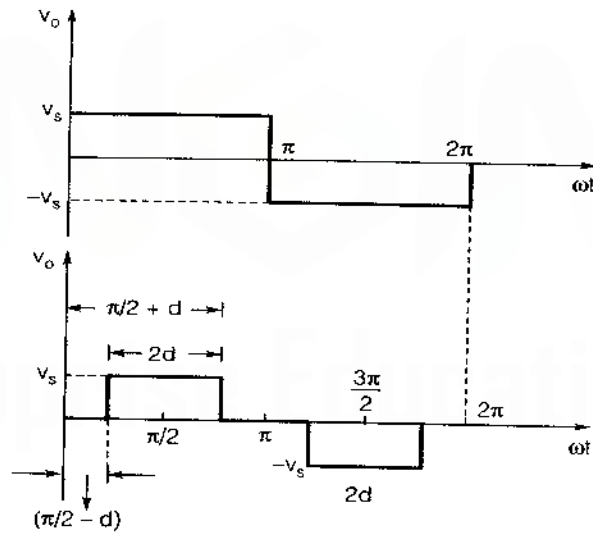

- Output voltage

$$V_0 = \sum_{n=1,3,5,\dots} \frac{4V_s}{n\pi} \sin \frac{n\pi}{2} \sin nd \cdot \sin n\omega t$$

- Pulse width

$$\text{Pulse width} = 2d$$

- Peak value of nth harmonic

$$V_{o, nm} = \frac{4V_s}{n\pi} \sin nd$$

- RMS value of output voltage

$$V_{or} = V_s \left[\frac{2d}{\pi} \right]^{1/2}$$

$$\text{FDF}(g) = \frac{2\sqrt{2} \sin d}{\sqrt{\pi} \cdot 2d}$$

$$\text{THD} = \sqrt{\frac{1}{g^2} - 1}$$

Remember:

When pulse width $2d = \frac{2\pi}{n}$, then nth harmonic eliminated.

2. Multiple Pulse Width Modulation

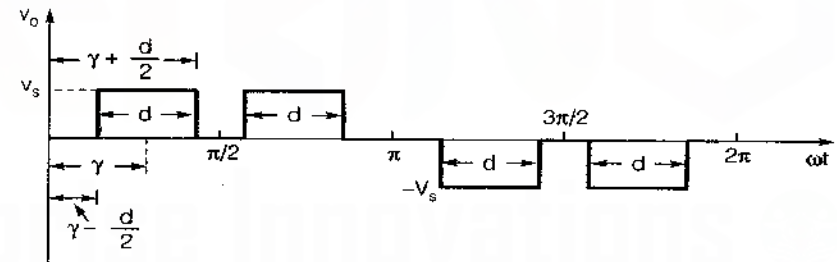

- Output voltage

$$V_0 = \sum_{n=1,3,5,\dots} \frac{8V_s}{n\pi} \sin n\gamma \cdot \sin \frac{nd}{2} \cdot \sin n\omega t$$

$$\gamma = \frac{\pi - 2d}{N+1} + \frac{d}{N}$$

where, N = Number of pulses per half cycle.

- Amplitude of the n^{th} harmonic of the two pulse wave form

$$V_n = \frac{8V_s}{n\pi} \sin n\gamma \cdot \sin \frac{nd}{2}$$

- Condition to eliminate n^{th} harmonic

$$(i) \gamma = \frac{\pi}{n} \quad (ii) 2d = \frac{4\pi}{n}$$

Remember:

- By using PWM technique, we can get variable voltage and frequency within inverter itself by eliminating some of the lower order harmonics.
- In PWM inverter, force commutation is essential.



AC Voltage Controllers

8

AC Voltage Controllers

A.C. voltage controllers are thyristor based devices which convert fixed alternating voltage directly to variable alternating voltage without, change in the frequency.

1. Single phase half wave ac voltage controller

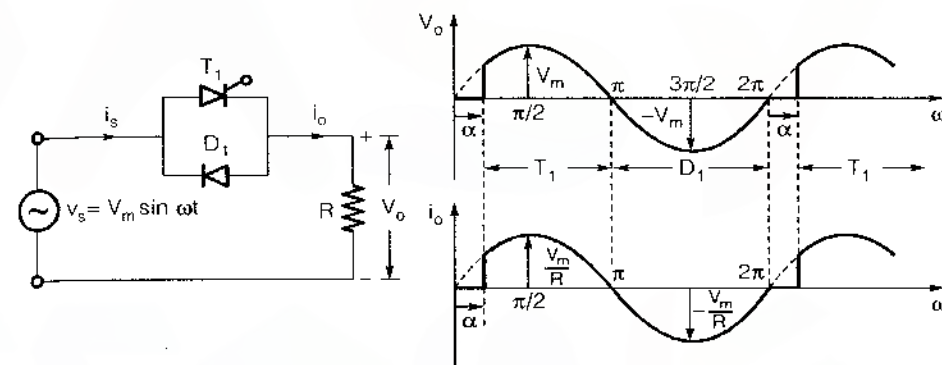

- RMS value of output voltage

$$V_{or} = \frac{V_m}{2} \left[\frac{1}{\pi} \left\{ (2\pi - \alpha) + \frac{\sin 2\alpha}{2} \right\} \right]^{1/2}$$

- Average value of output voltage

$$V_o = \frac{V_m}{2\pi} (\cos \alpha - 1)$$

2. Single phase full wave ac voltage controller

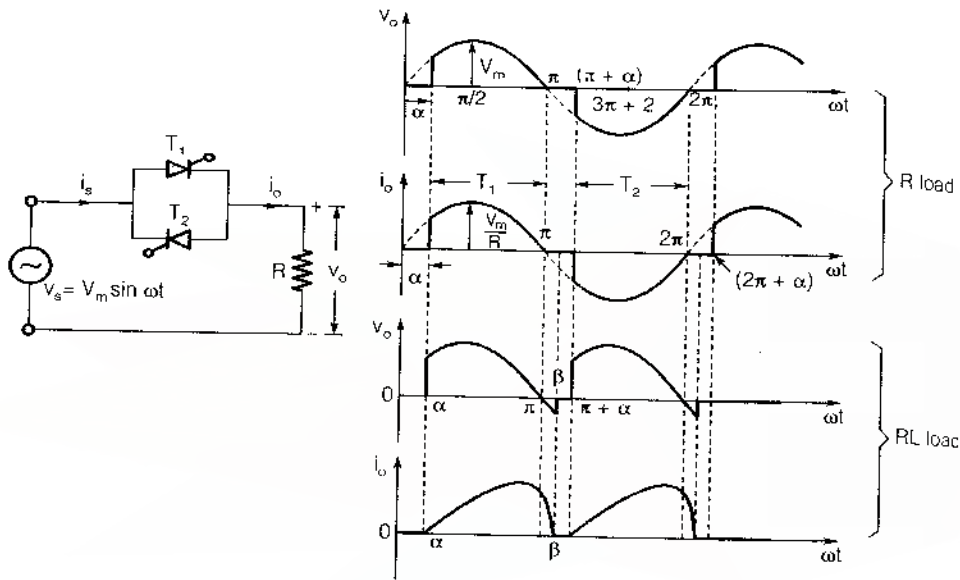

□ RMS value of output voltage for R load

$$V_{or} = \frac{V_m}{\sqrt{2}} \left[\frac{1}{\pi} \left\{ (\pi - \alpha) + \frac{1}{2} \sin 2\alpha \right\} \right]^{1/2}$$

□ RMS value of output voltage for RL load

$$V_{or} = \frac{V_m}{\sqrt{2\pi}} \left[(\beta - \alpha) + \frac{1}{2} (\sin 2\alpha - \sin 2\beta) \right]^{1/2}$$

Remember:

- For RL load, output voltage is controllable only when $\alpha > \phi$ where

$$\phi = \tan^{-1} \frac{\omega L}{R}$$

- Range of α for getting controllable output voltage

$$\phi \leq \alpha \leq 180^\circ$$

- Average value of output voltage would be zero.

Integral Cycle Control

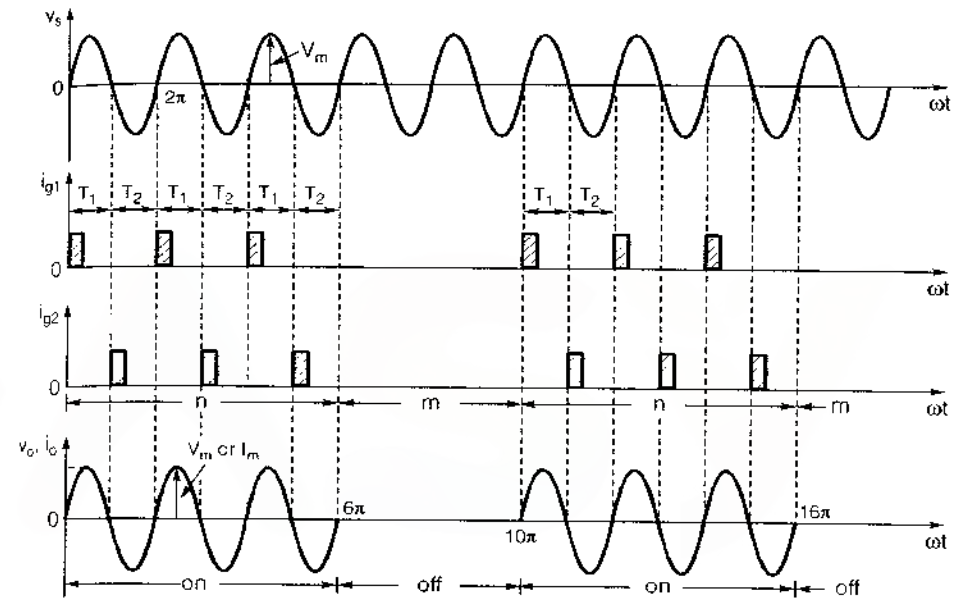

Integral cycle control for n on-cycles and m off cycles

□ Rms value of output voltage

$$V_{or} = \frac{V_m}{\sqrt{2}} \sqrt{\frac{n}{n+m}} = V_s \sqrt{k}$$

where, $k = \frac{n}{n+m}$ = duty cycle of ac voltage controller

V_{or} = RMS value of output voltage

V_s = RMS value of source voltage

□ Power delivered to load

$$P = \frac{kV_s^2}{R}$$

□ Input power factor

$$p.f. = \sqrt{\frac{n}{n+m}} = \sqrt{k}$$

Note:

- Integral cycle control method is used only for those load which have high time constant.
- AC voltage controller is used for domestic and industrial heating, speed control of 1 ϕ and 3 ϕ AC drives, starting of induction motors.
- Disadvantage of AC voltage controller is introduction of objectionable harmonics in the supply current and load voltage waveforms.

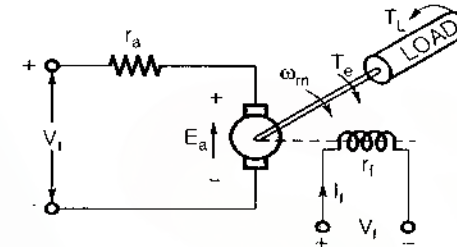
**Electric Drives****9****DC Drives****1. Separately-excited DC motor**

- Voltage across field winding

For field circuit

$$V_f = I_f \cdot r_f$$

where, I_f = Field winding current, A
 r_f = Field circuit resistance, Ω

- Motor terminal voltage

For armature circuit

$$V_t = E_a + I_a r_a$$

where, I_a = Armature current, A
 r_a = Armature circuit resistance, Ω
 E_a = Back emf, V
 V_t = Armature terminal voltage, V

- Motor back emf

$$E_a = k_a \phi \omega_m = k_m \omega_m$$

where, ϕ = Field flux per pole, Wb
 ω_m = Angular speed of motor, rad/sec.
 $k_m = k_a \phi$ = torque constant, Nm/A

- Motor torque

$$T_e = k_m I_a$$

- Angular speed of motor

$$\omega_m = \frac{V_t - I_a r_a}{k_m}$$

2. DC Series motor

- Motor terminal voltage

$$V_t = E_a + I_a(r_a + r_s)$$

- Motor torque

$$T_e = K_a \phi I_a$$

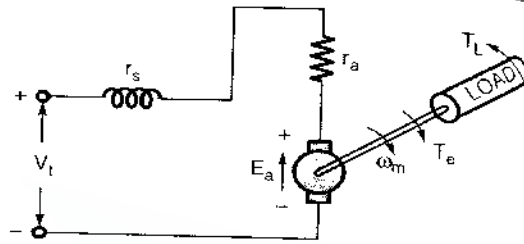

For no saturation in the magnetic circuit

- Field flux per pole

$$\phi = k I_a$$

- Motor torque

$$T_e = K I_a^2$$

where, $K = k_a k = \text{constant, Nm/A}^2$

- Motor back emf

$$E_a = K I_a \omega_m$$

- Angular speed of motor

$$\omega_m = \frac{V_t (r_a + r_s)}{K I_a}$$

where, $r_s = \text{Series-field resistance, } \Omega$

Single Phase DC Drives

1. Single Phase Half Wave Converter Drives

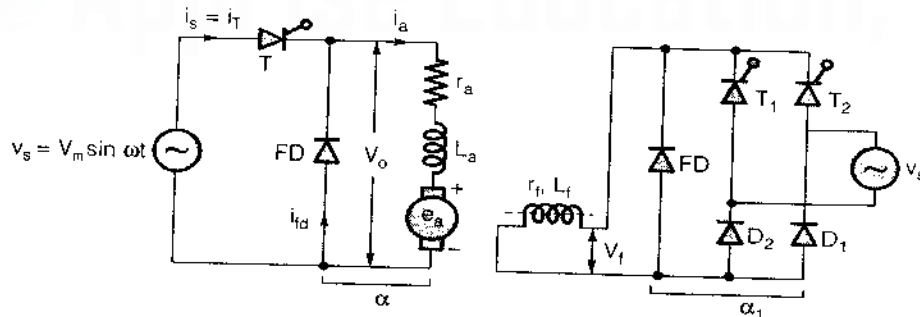

- Average output voltage of converter
For $0 < \alpha < \pi$

$$V_o = V_t = \frac{V_m}{2\pi} (1 + \cos \alpha)$$

where $V_m = \text{Maximum value of source voltage, V}$

$V_o = V_t = \text{Armature terminal voltage, V}$

For single-phase semiconverter in the field circuit

- Average output voltage
For $0 < \alpha_1 < \pi$

$$V_t = \frac{V_m}{\pi} (1 + \cos \alpha_1)$$

- RMS value of source current

$$I_{sr} = I_a \sqrt{\frac{\pi - \alpha}{2\pi}}$$

- Apparent input power

$$P_i = V_s I_{sr}$$

- Power delivered to motor

$$P = V_t I_a$$

2. Single phase semiconverter Drives

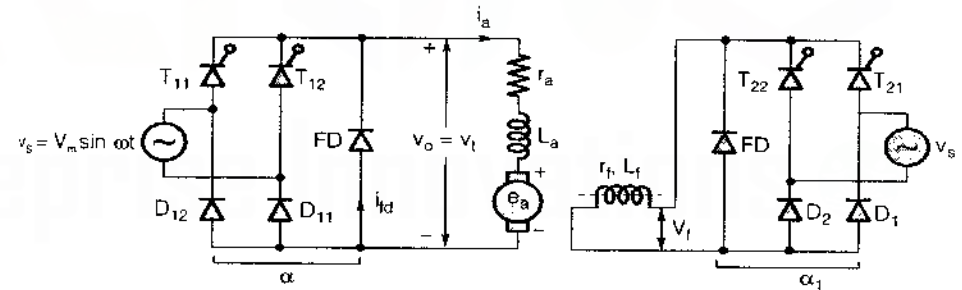

- Average output voltage

$$V_o = V_t = \frac{V_m}{\pi} (1 + \cos \alpha)$$

□ For field circuit

$$V_f = \frac{V_m}{\pi} (1 + \cos \alpha_1)$$

□ RMS value of source current

$$I_{sr} = I_a \sqrt{\frac{\pi - \alpha}{\pi}}$$

3. Single Phase Full Converter Drives

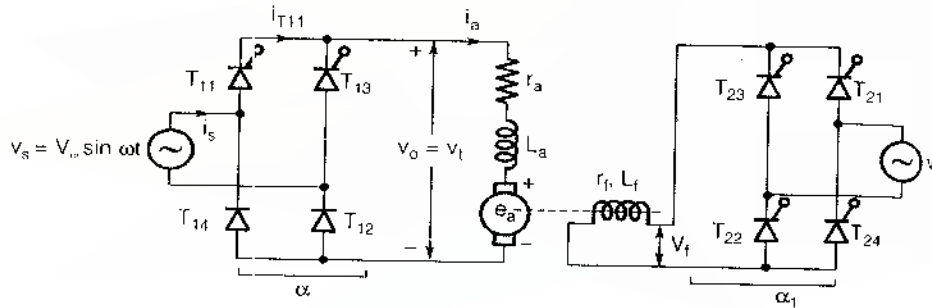

For armature converter 1

$$V_0 = V_t = \frac{2V_m}{\pi} \cos \alpha \quad \dots \text{for } 0 < \alpha < p$$

For the field converter 2

$$V_f = \frac{2V_m}{\pi} \cos \alpha_1 \quad \dots \text{for } 0 < \alpha_1 < p$$

□ RMS value of source current

$$I_{sr} = I_a$$



A Handbook on Electrical Engineering

4

Measurements and Instrumentation

CONTENTS

1. Characteristics of Instruments and Measurement Systems	220
2. Circuit Components (Resistors, Inductors, Capacitors)	228
3. Galvanometers	232
4. Analog Meters	235
5. Instrument Transformers	245
6. Measurement of Power and Wattmeters	249
7. Measurement of Resistance	256
8. A.C. Bridges	265
9. Magnetic Measurements	275
10. Electronic Instruments	277
11. Cathode Ray Oscilloscope	279
12. High Frequency Measurements	283
13. Transducers	285

Characteristics of Instruments and Measurement Systems

1

Measurements

Measurement is a process by which one can convert physical parameters to meaningful numbers. The measuring process is one in which the property of an object or system under consideration is compared to an accepted standard unit, a standard defined for that particular property.

Static Characteristics

1. Accuracy

It is the closeness with which an instrument reading approaches the true value of the quantity being measured.

2. Precision

It is a measure of the reproducibility of the measurements. It is a measure of degree of agreement within a group of measurements.

Remember:

- Precision is not the guarantee of accuracy.
- An instrument with more significant figure has more precision.

3. Sensitivity

It is the ratio of the magnitude of output signal to the magnitude of input signal applied to the instrument.

$$\text{Sensitivity} = \frac{\text{Output}}{\text{Input}}$$

Note:

- An instrument requires high degree of sensitivity.

$$\text{Sensitivity} \propto \frac{1}{\text{Deflection factor}}$$

4. Resolution

The smallest change in input which can be detected with certainty by an instrument is its resolution.

5. Linearity

The output is linearly proportional to the input. For a linear instrument the sensitivity is constant for the entire range of instrument. Linearity is the most important parameter compared to all other parameters.

Remember:

- Linearity is more important than the sensitivity.
- Accuracy is more important than resolution.

6. Dead Zone

It is the largest change of input quantity for which there is no output of the instrument.

7. Dead time

Time required by an instrument to begin to respond to the change in a measurand.

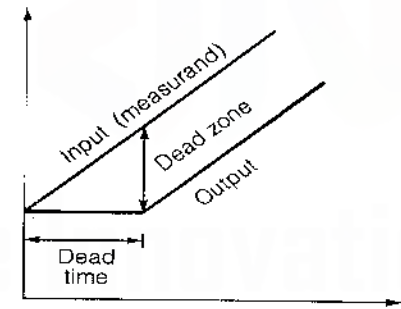

8. Range and Span

The difference between the maximum and minimum values of the scale is called range. The maximum value of the scale is called span.

Errors

$$\text{Error} = \text{Measured value} - \text{True value}$$

$$\text{Error} = - \text{Accuracy}$$

□ Static Error

$$\delta A = A_m - A_t$$

where, A_m = Measured value of quantity or Actual value

A_t = True value of quantity or Nominal value

□ Relative static error

$$\epsilon_r = \frac{\delta A}{A_t}$$

□ Static correct on

$$\delta C = A_t - A_m = -\delta A$$

□ Static sensitivity

$$\text{Static sensitivity} = \frac{\Delta q_o}{\Delta q_i}$$

where, Δq_o = Infinitesimal change in output

Δq_i = Infinitesimal change in input

□ Non-linearity (N.L.)

$$\text{N.L.} = \frac{(\text{Max. deviation of output from the idealized straight line})}{\text{Full scale deflection}} \times 100$$

$$\text{Error at desired value} = \frac{\text{Full scale value} \times \text{Error at full scale}}{\text{Desired value}}$$

Combination of Quantities with Limiting Errors

Sum or Difference of Two or More than Two Quantities

Let $X = \pm x_1 \pm x_2 \pm x_3 \pm x_4$

$$\frac{\delta X}{X} = \pm \left(\frac{x_1}{X} \frac{\delta x_1}{x_1} + \frac{x_2}{X} \frac{\delta x_2}{x_2} + \frac{x_3}{X} \frac{\delta x_3}{x_3} + \frac{x_4}{X} \frac{\delta x_4}{x_4} \right)$$

where

$\pm \delta x_1$ = Relative increment in quantity x_1

$\pm \delta x_2$ = Relative increment in quantity x_2

$\pm \delta X$ = Relative increment in X

$\frac{\delta x_1}{x_1}$ = Relative limiting error in quantity x_1

$\frac{\delta x_2}{x_2}$ = Relative limiting error in quantity x_2

$\frac{\delta X}{X}$ = Relative limiting error in X

Product or Quotient of Two or More than Two Quantities

Let $X = x_1 x_2 x_3$ or $X = \frac{x_1}{x_2 x_3}$ or $X = \frac{1}{x_1 x_2 x_3}$

$$\frac{\delta X}{X} = \pm \left(\frac{\delta x_1}{x_1} + \frac{\delta x_2}{x_2} + \frac{\delta x_3}{x_3} \right)$$

Composite Factors

Let $X = x_1^n \cdot x_2^m$

$$\frac{\delta X}{X} = \pm \left(n \frac{\delta x_1}{x_1} + m \frac{\delta x_2}{x_2} \right)$$

□ Arithmetic Mean

$$\bar{X} = \frac{\sum X}{n} = \frac{X_1 + X_2 + \dots + X_n}{n}$$

where, x_1, x_2, \dots, x_n = Readings or samples

n = Number of readings

Deviation

$$d_n = x_n - \bar{X}$$

Note:

Algebraic sum of deviation is zero.

□ Average deviation

$$\bar{D} = \frac{\sum |d|}{n} = \frac{|d_1| + |d_2| + \dots + |d_n|}{n}$$

□ Standard deviation

For $n > 20$

$$\text{S.D.} = \sigma = \sqrt{\frac{\sum d^2}{n}} = \sqrt{\frac{d_1^2 + d_2^2 + \dots + d_n^2}{n}}$$

For $n < 20$

$$\text{S.D.} = s = \sqrt{\frac{\sum d^2}{n-1}}$$

□ Variance

For $n > 20$

$$V = \sigma^2 = \frac{\sum d^2}{n}$$

For $n < 20$

$$V = s^2 = \frac{\sum d^2}{n-1}$$

Normal or Gaussian Curve of Errors

1. For Infinite Numbers of Reading

$$y = \frac{1}{\sigma\sqrt{2\pi}} \exp(-x^2/2\sigma^2)$$

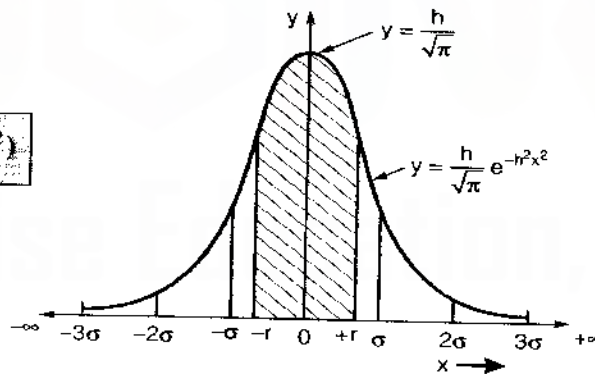

where, x = magnitude of deviation from mean,
 y = number of readings at any deviation x , (the probability of occurrence of deviation x)
 σ = standard deviation

□ Precision Index

$$h = \frac{1}{\sigma\sqrt{2}}$$

□ Probable error (P.E.)

$$r = \frac{0.4769}{h}$$

□ Average deviation

$$D = \frac{r}{0.8453} = \frac{1}{\pi h^2}$$

□ Standard deviation

$$\sigma = \frac{r}{0.6745} = \frac{1}{h\sqrt{2}}$$

$$\text{P.E.} = r = 0.8453 D = 0.6745 \sigma$$

2. For Finite Numbers of Reading

□ For $n > 20$

$$\text{P.E.} = r = 0.6745 \sqrt{\frac{\sum |d|^2}{n}}$$

□ For $n < 20$

$$\text{P.E.} = r = 0.6745 \sqrt{\frac{\sum |d|^2}{n-1}}$$

□ Standard deviation of mean

$$\sigma_m = \frac{\sigma}{\sqrt{n}}$$

□ Standard deviation of standard deviation

$$\sigma_\sigma = \frac{\sigma_m}{\sqrt{2}}$$

□ Variance of combination of components

Let $X = f(x_1, x_2, \dots, n)$

$$V_x = \left(\frac{\partial X}{\partial x_1}\right)^2 V_{x_1} + \left(\frac{\partial X}{\partial x_2}\right)^2 V_{x_2} + \dots + \left(\frac{\partial X}{\partial x_n}\right)^2 V_{x_n}$$

where, $V_{x_1}, V_{x_2}, \dots, V_{x_n}$ = Variance of x_1, x_2, \dots, x_n

□ Standard Deviation of Combination of Components

Let $X = f(x_1, x_2, \dots, x_n)$

$$\sigma_x = \sqrt{\left(\frac{\partial X}{\partial x_1}\right)^2 \sigma_{x_1}^2 + \left(\frac{\partial X}{\partial x_2}\right)^2 \sigma_{x_2}^2 + \dots + \left(\frac{\partial X}{\partial x_n}\right)^2 \sigma_{x_n}^2}$$

where, $\sigma_{x_1}, \sigma_{x_2}, \dots, \sigma_{x_n}$ = Standard deviation of x_1, x_2, \dots, x_n

□ Probable Error of Combination of Components

Let $X = f(x_1, x_2, \dots, x_n)$

$$r_x = \sqrt{\left(\frac{\partial X}{\partial x_1}\right)^2 r_{x_1}^2 + \left(\frac{\partial X}{\partial x_2}\right)^2 r_{x_2}^2 + \dots + \left(\frac{\partial X}{\partial x_n}\right)^2 r_{x_n}^2}$$

where, $r_{x_1}, r_{x_2}, \dots, r_{x_n}$ = Probable error of x_1, x_2, \dots, x_n

□ Uncertainty of Combination of Components

Let $X = f(x_1, x_2, \dots, x_n)$

$$w_x = \sqrt{\left(\frac{\partial X}{\partial x_1}\right)^2 w_{x_1}^2 + \left(\frac{\partial X}{\partial x_2}\right)^2 w_{x_2}^2 + \dots + \left(\frac{\partial X}{\partial x_n}\right)^2 w_{x_n}^2}$$

where, $w_{x_1}, w_{x_2}, \dots, w_{x_n}$ = Uncertainties of x_1, x_2, \dots, x_n

Order of Instrument

1. Zero Order System

As input changes, output also changes immediately called zero order system. Example : Resistor.

2. First Order System

As input changes, output also changes but not immediately, it takes some delay but without oscillation. Example : heater.

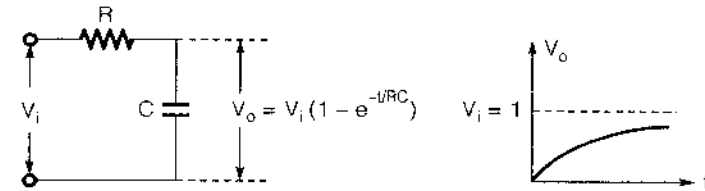

3. Second Order System

As input changes, output also changes, with some delay and oscillation.

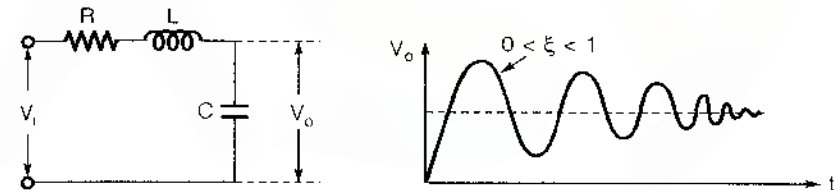

Remember:

- The analog instruments are of second order instrument which has damping factor (ξ) between 0.6 to 0.8. It is an underdamped system.

Standards

Quantity	Unit	Definition
Length	Metre	The length of path travelled by light in an interval of $\frac{1}{299792458}$ sec.
Time	second	9.192631770×10^9 cycles of radiation from vapourised cesium-133 atom.
Temp.	Kelvin	The temperature difference between the absolute and the triple point of water is defined as 273.16°K.
Voltage	Volt	Standard cell voltage of weston cell i.e. 1.0186 V.
Current	Ampere	One ampere is the current flowing through two infinite long parallel conductor of negligible cross section placed 1 meter apart produced a force of 2×10^{-7} N/m.

Circuit Components (Resistors, Inductors, Capacitors)

2

- Effective resistance for zero effective inductance

$$R_{\text{eff}} = \frac{R}{1 - \omega^2 LC}$$

- Quality factor

$$Q = \frac{\omega L}{R}$$

Frequency Errors in Inductors

- Effective resistance

$$R_{\text{eff}} = \frac{R}{(1 - \omega^2 LC)^2}$$

- Effective inductance

$$L_{\text{eff}} = L(1 + \omega^2 LC)$$

Capacitor

1. Parallel Representation

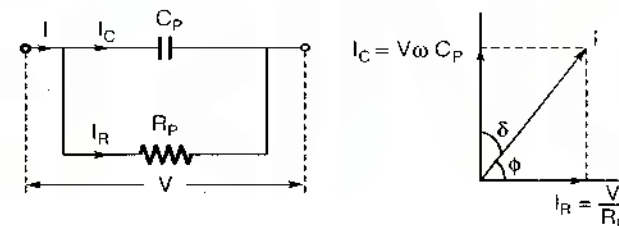

- Dielectric loss

$$P_L = \omega C_P V^2 \tan \delta$$

- Dissipation factor

$$D = \tan \delta = \frac{1}{\omega C_P R_P}$$

where, δ = loss angle of the capacitor.

Frequency Errors in Resistors

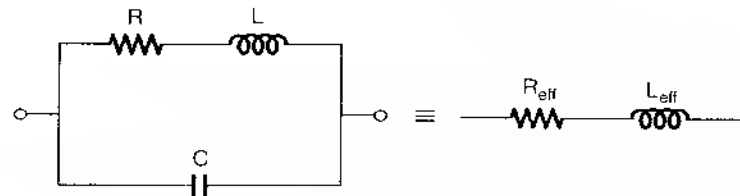

(Equivalent circuit of a resistor at low and medium frequencies)

- Effective resistance

$$R_{\text{eff}} = \frac{R}{1 + \omega^2 C(CR^2 - 2L)}$$

- Effective inductance or residual inductance

$$L_{\text{eff}} = \frac{L - CR^2}{1 + \omega^2 C(CR^2 - 2L)}$$

$$\tan \phi = \frac{X_{\text{eff}}}{R_{\text{eff}}} = \frac{\omega L_{\text{eff}}}{R_{\text{eff}}} = \frac{\omega(L - CR^2)}{R} = \omega \left(\frac{L}{R} - CR \right)$$

where, ϕ = Phase deflection angle

- Time constant

$$\tau = \frac{L_{\text{eff}}}{R_{\text{eff}}} = \frac{L - CR^2}{R} = \frac{L}{R} - CR$$

- Condition for resistance to remain independent of frequency

$$CR^2 = 2L$$

- Condition for resistance to show no inductive effect

$$CR^2 = L$$

2. Series Representation

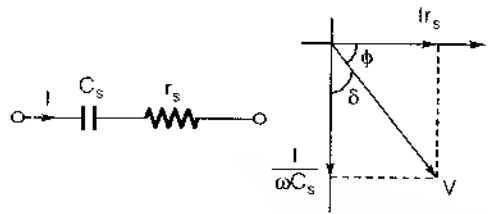

- Dielectric loss

$$P_L = \frac{I^2}{\omega C_s} \tan \delta$$

- Dissipation factor

$$D = \tan \delta = \omega C_s r_s$$

Frequency Errors in Capacitors

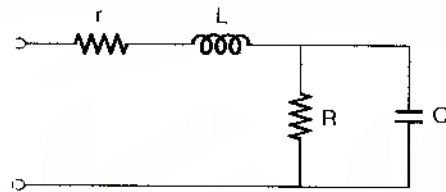

Equivalent Circuit of a Capacitor

- Effective capacitance

$$C_{\text{eff}} = \frac{C}{1 - \omega^2 LC}$$

1. For Medium Frequency

- Effective capacitance

$$C_{\text{eff}} = C(1 + \omega^2 LC)$$

- Effective series resistance

$$R_{\text{eff}} = r + \frac{R}{1 + \omega^2 R^2 C^2}$$

where, r = resistance of lead

- Loss angle

$$\tan \delta = \frac{1 - \omega^2 LC}{\omega r + \frac{1}{\omega CR}}$$

2. For Low Frequency

- Effective capacitance

$$C_{\text{eff}} = C + \frac{1}{\omega^2 CR^2}$$

- Effective series resistance

$$R_{\text{eff}} = \frac{R}{1 + \omega^2 C^2 R^2}$$

- Loss angle

$$\tan \delta = \omega Cr + \frac{1}{\omega CR}$$



Galvanometers

3

MADE EASY ■

D' Arsonval Galvanometer

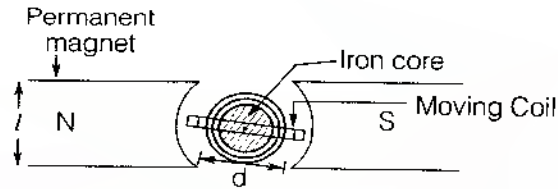

□ Deflecting torque

$$T_d = BiNA = Gi$$

- where, B = Flux density in air gap; Wb/m^2
 i = Current through moving coil; A
 N = Number of turns in coil
 $A = ld$ = Area of coil; m^2
 l, d = Length of vertical and horizontal side (width) of coil respectively; m
 G = Displacement constant of galvanometer

□ Controlling torque

$$T_c = K\theta_f$$

- where, K = Spring constant of suspension; Nm/rad
 θ_f = Final steady deflection of moving coil; rad

□ Final steady deflection

$$\theta_f = \left(\frac{NBA}{K}\right) i = \left(\frac{G}{K}\right) i$$

Dynamic behaviour of Galvanometers

Torques in Galvanometers

□ Inertia torque

$$T_i = J \frac{d^2\theta}{dt^2}$$

- where, J = moment of inertia of moving system about the axis of rotation; $kg\cdot m^2$,
 θ = deflection at any time t ; rad .

□ Damping torque

$$T_D = D \frac{d\theta}{dt}$$

- where, D = damping constant

□ Controlling torque

$$T_c = K\theta$$

- where, K = control constant

□ Deflecting Torque

$$T_d = Gi$$

□ Equation of motion

$$T_j + T_D + T_c = T_d$$

$$J \frac{d^2\theta}{dt^2} + \frac{Dd\theta}{dt} + K\theta = Gi$$

Note:

- If $D^2 < 4KJ$, galvanometer is underdamped.
- If $D^2 = 4KJ$, galvanometer is critically damped.
- If $D^2 > 4KJ$, galvanometer is overdamped.

□ Total resistance of galvanometer circuit for critical damping

$$R = \frac{G^2}{2\sqrt{KJ}}$$

□ External series resistance required for critical damping

$$R_e = R - R_g = \frac{G^2}{2\sqrt{KJ}} - R_g$$

- where, R_g = Resistance of galvanometer

Sensitivity

□ Current sensitivity

$$S_i = \frac{\theta_f}{i} = \frac{G}{K} \text{ rad/A}$$

$$S_i = \frac{d}{i \times 10^6} \text{ scale divisions}/\mu\text{A}$$

$$S_i = \frac{2000 G}{K \times 10^6} \text{ mm}/\mu\text{A}$$

□ Voltage sensitivity

$$S_v = \frac{d}{i R_g \times 10^6} \text{ scale division}/\mu\text{V}$$

□ Megohm sensitivity

$$S_o = \frac{d}{i \times 10^{-6}} \text{ M}\Omega/\text{scale division}$$

Remember:

Sensitive galvanometer is one which produces a large deflection for a small current.



Analog Meters

4

Classification of Analog Meters

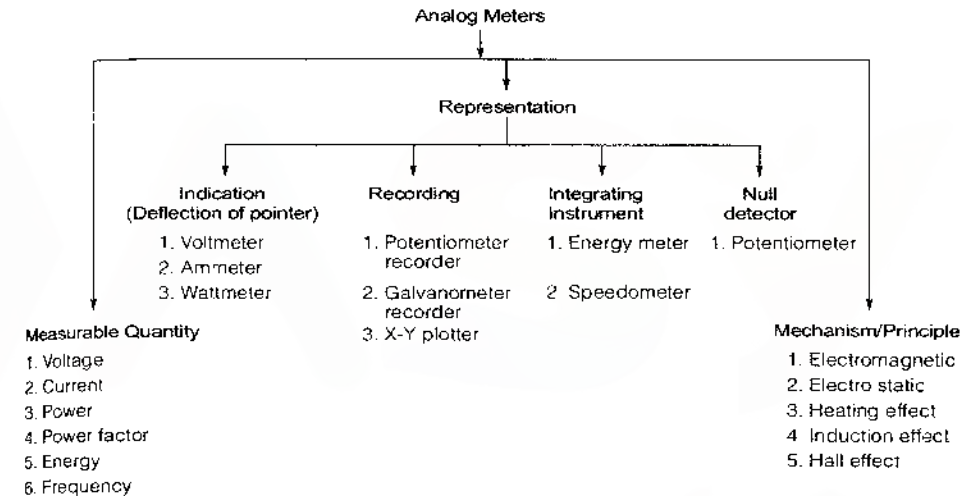

Torque in Analog Meter

1. Deflecting Torque (T_D)

Deflecting torque is proportional to quantity under measurement. This torque deflect the pointer away from initial or zero position.

$$T_D \propto \text{Measurable quantity}$$

2. Controlling Torque (T_C)

The controlling torque is opposite to deflecting torque. When, deflecting torque equals to controlling torque, pointer comes to final steady state position.

At equilibrium,

$$T_C = T_D$$

Note:

- Control torque is also used to bring the pointer in zero initial position, if there is no deflecting torque.
- Except in PMMC, in all other instruments if the control spring is failed or broken then pointer moves to the maximum position of scale.
- Control torque is provided by
 - (i) Spring control
 - (ii) Gravity control

3. Damping Torque

It is used to damp out oscillation at final steady state position. The time response of the instrument depends on damping torque.

Damping torque provided by:

- (i) **Air friction damping:** Used where low magnetic fields are produced
- (ii) **Fluid friction damping:** Used where deflecting torque is minimum.
- (iii) **Eddy current damping:** Used where permanent magnet produces the required deflecting torque.

Error in Analog Meters**1. Frictional Error**

To reduce the frictional error, the torque to weight ratio of the instrument should be high.

2. Temperature Error

Due to change in temperature, change in resistance of meters and shunts and series multiplier occurs. To reduce this effect, resistances are made up of manganin material.

3. Frequency Error

Due to change in frequency, error produce in instrument because change in frequency cause change in reactance. To reduce this error, a capacitance is used in case of voltmeter and for ammeter, the time constant and shunt impedances are maintained at same value.

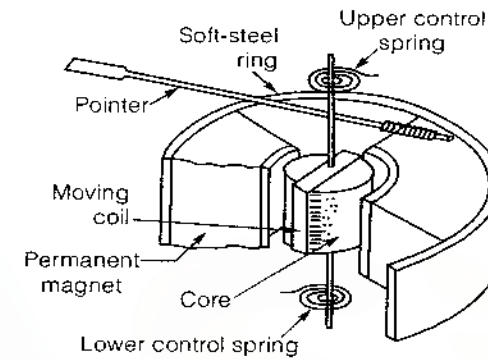
Permanent Magnet Moving Coil (PMMC)**□ Deflection torque**

$$T_D = nBAI$$

$$T_D = GI$$

where, $G = nBA$
 $n =$ Number of turns
 $B =$ Flux density
 $A =$ Area of core
 $I =$ Current to be measured

□ Final steady state deflection

$$\theta = \left(\frac{G}{K} \right) I$$

where, $K =$ Spring constant

Note:

- PMMC instrument measures only DC or average values.
- Scale is linear.
- Spring is used for controlling torque.
- Damping torque provided by eddy current damping.
- It has more, torque to weight ratio so accuracy and sensitivity is higher compare to other instrument.

- In direct measurement, the PMMC measures upto a current of 50 mA or a voltage of 100 mV, without any external device.

Enhancement of Ammeters and Voltmeters

1. Ammeter Shunts

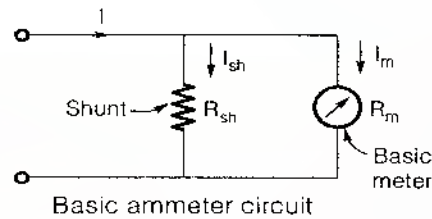

$$I_{sh} R_{sh} = I_m R_m$$

$$I = \left(1 + \frac{R_m}{R_{sh}}\right) I_m$$

where, I = Current to be measured ;
 $I_m = I_{fs}$ = Full scale deflection current ; A
 R_m = Internal resistance of meter ; Ω
 R_{sh} = Resistance of the shunt ; Ω

□ Shunt resistance

$$R_{sh} = \frac{R_m}{m - 1}$$

where, $m = \frac{I}{I_m} = 1 + \frac{R_m}{R_{sh}}$

m = Multiplying factor for shunt

Note:

To reduce the temperature effect, swamp resistance made up of manganin is added in series with ammeter.

2. Universal or Ayrton Shunt

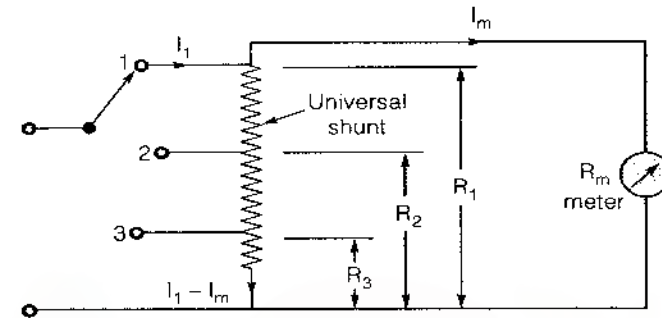

(Multi-range ammeter using universal shunt)

□ For switch at a position 1

$$R_1 = \frac{R_m}{(m - 1)}$$

□ For switch at a position 2

$$R_2 = \frac{(R_1 + R_m)}{m_2}$$

□ For switch at a position 3

$$R_3 = \frac{(R_1 + R_m)}{m_3}$$

where, $m_1 = \frac{I_1}{I_m}$, $m_2 = \frac{I_2}{I_m}$, $m_3 = \frac{I_3}{I_m}$

3. Voltmeter Multipliers

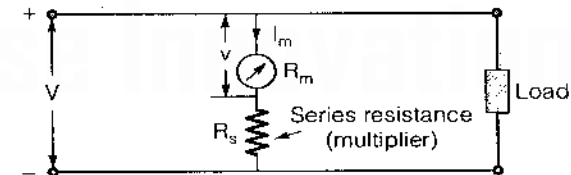

□ Multiplying factor for multiplier

$$m = \frac{V}{v} = 1 + \frac{R_s}{R_m}$$

Resistance of multiplier

$$R_s = (m - 1)R_m$$

where, R_s = Multiplier resistance
 R_m = Internal resistance of meter

4. Potential Divider Arrangement

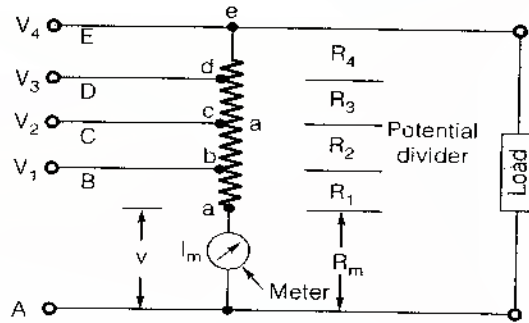

$$R_1 = (m_1 - 1) R_m$$

$$R_2 = (m_2 - m_1) R_m$$

$$R_3 = (m_3 - m_2) R_m$$

$$R_4 = (m_4 - m_3) R_m$$

where, R_1 = Resistance between point a and b
 R_2 = Resistance between point b and c
 R_3 = Resistance between point c and d
 R_4 = Resistance between point d and e

Voltmeter Sensitivity (S_v)

$$S_v = \frac{1}{I_{fs}} = \frac{R_s + R_m}{V} \Omega/V$$

Remember:

To reduce loading effect, a voltmeter with higher value of sensitivity is preferred.

Moving Iron Instruments

Deflecting torque

$$T_d = \frac{1}{2} I^2 \frac{dL}{d\theta}$$

Deflection

$$\theta = \frac{1}{2} \frac{I^2 \cdot dL}{K \cdot d\theta}$$

For linear scale

$$\theta \cdot \frac{dL}{d\theta} = \text{constant}$$

Scale is cramped at lower and higher end.

Note:

- Moving iron instrument measure both A.C. and D.C. quantities.
- In case of A.C., it measure RMS value.
- Scale is non linear.
- Controlling torque is provided by spring and air friction damping is used.
- Curve between $\frac{dL}{d\theta}$ and θ is rectangular hyperbola.

Shunts for Moving Iron Instruments

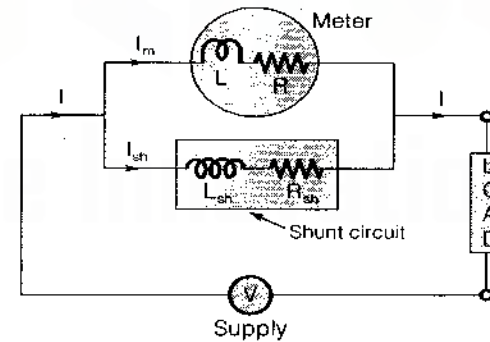

$$\frac{I_{sh}}{I_m} = \frac{R_m \sqrt{1 + (\omega L / R)^2}}{R_{sh} \sqrt{1 + (\omega L_{sh} / R_{sh})^2}}$$

Multipliers for Moving Iron Instruments

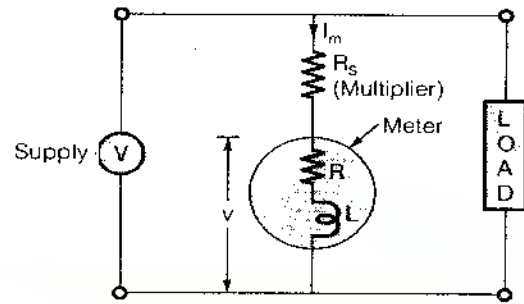

□ Voltage multiplying factor

$$m = \frac{V}{v} = \frac{\sqrt{(R + R_s)^2 + \omega^2 L^2}}{\sqrt{R^2 + \omega^2 L^2}}$$

Errors in Moving Iron Instruments

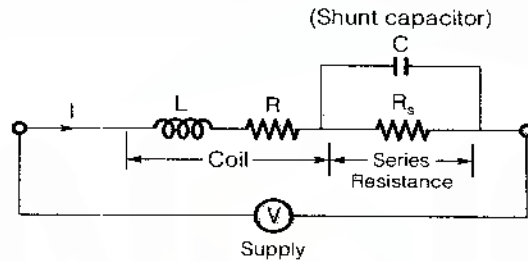

□ Shunt capacitance

$$C = 0.41 \frac{L}{R_s^2}$$

□ Eddy currents

When ω is small

$$r_e = \frac{\omega^2 M L_e I}{R_e^2}$$

When ω is large

$$r_e = \frac{M I}{L_e} = \text{constant}$$

where, R_e, L_e = resistance and inductance of eddy current path

Note:

- Moving iron instrument is not suitable for measurement of current or voltage for frequency above 125 Hz because eddy current is constant at higher frequency.
- If meter time constant is equal to shunt time constant then ammeter is made independent of input supply frequency.
- The voltmeter is made independent of input supply frequency by connecting a capacitor in parallel to the series multiplier resistance R_s .
- To reduce hysteresis error, the iron part of moving iron is made up of Nickel iron alloy.
- To reduce the external stray magnetic field, the instrument is kept inside the iron case or iron shielding is done.

Electrodynamometer

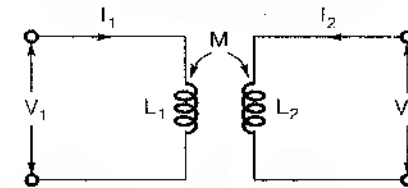

(a) If i_1 and i_2 are D.C. current i.e. $i_1 = i_2 = I$

$$T_d = I^2 \frac{dM}{d\theta} \quad \text{(Measure average value)}$$

(b) If i_1 and i_2 are A.C. current and no phase shift

$$i_1 = i_2 = I$$

$$T_d = I^2 \frac{dM}{d\theta} \quad \text{(Measure RMS value)}$$

(c) If $i_1 = I_{m1} \sin \omega t$ and $i_2 = I_{m2} \sin(\omega t - \phi)$

$$T_d = I_1 I_2 \cos \phi \frac{dM}{d\theta} \quad \text{(Measure RMS value)}$$

Where, $I_1 = \frac{I_{m1}}{\sqrt{2}}$ and $I_2 = \frac{I_{m2}}{\sqrt{2}}$

Note:

- Electrodynamometer instrument is a transfer instrument.
- It measures both A.C. and D.C.
- Scale is nonlinear.
- Its sensitivity is lesser than PMMC and M.I. type instruments.

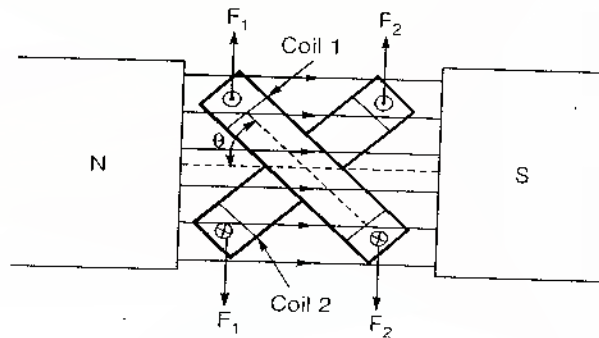
Ratiometer

- Deflecting torque acting on coil 1

$$T_{d1} = N_1 B l_1 d_1 i_1 \cos \theta$$

- Deflecting torque acting on coil 2

$$T_{d2} = N_2 B l_2 d_2 i_2 \cos \theta$$

where, i_1, i_2 = current in coil 1 and 2

N_1, N_2 = number of turns in coil 1 and 2

l_1, l_2 = length of coil 1 and 2

d_1, d_2 = width of coil 1 and 2

B = flux density of magnetic field

- Deflection at equilibrium

$$\theta = k \left(\frac{i_1}{i_2} \right)$$



Instrument Transformers

5

Ratios of Instrument Transformers

1. Transformation Ratio (R)

It is the ratio of the magnitude of the primary phasor to the secondary phasor.

$$R = \frac{|\text{primary phasor}|}{|\text{secondary phasor}|}$$

- For current transformer (C.T.)

$$R = \frac{\text{primary winding current}}{\text{secondary winding current}}$$

- For potential transformer (P.T.)

$$R = \frac{\text{primary winding voltage}}{\text{secondary winding voltage}}$$

2. Nominal Ratio (K_n)

It is the ratio of rated primary winding current (or voltage) to the rated secondary winding current (or voltage).

- For C.T.

$$K_n = \frac{\text{rated primary winding current}}{\text{rated secondary winding current}}$$

- For P.T.

$$K_n = \frac{\text{rated primary winding voltage}}{\text{rated secondary winding voltage}}$$

3. Turns Ratio (n)

- For C.T.

$$n = \frac{\text{number of turns of secondary winding}}{\text{number of turns of primary winding}}$$

□ For P.T.

$$n = \frac{\text{number of turns of primary winding}}{\text{number of turns of secondary winding}}$$

4. Ratio Correction Factor

$$RCF = \frac{R}{K_n}$$

Remember:

The ratio marked on the transformers is their nominal ratio.

Current Transformer

Equivalent Circuit

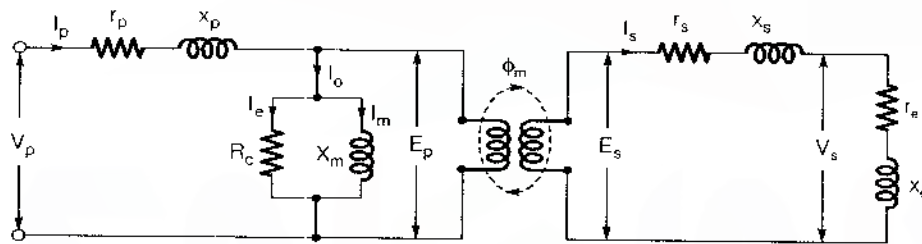

- where, r_s, x_s = resistance, reactance of secondary winding
- r_e, x_e = resistance, reactance of external burden
- E_p, E_s = primary and secondary winding induced voltage
- N_p, N_s = number of primary and secondary winding turns
- I_p, I_s = primary and secondary winding current
- ϕ = working flux of transformer
- θ = phase angle of transformer
- δ = angle between secondary winding induced voltage and secondary winding current
- Δ = phase angle of secondary winding load circuit
- I_o = exciting current
- I_m = magnetizing component of exciting current
- I_e = loss component of exciting current
- α = angle between exciting current and flux

Phasor Diagram

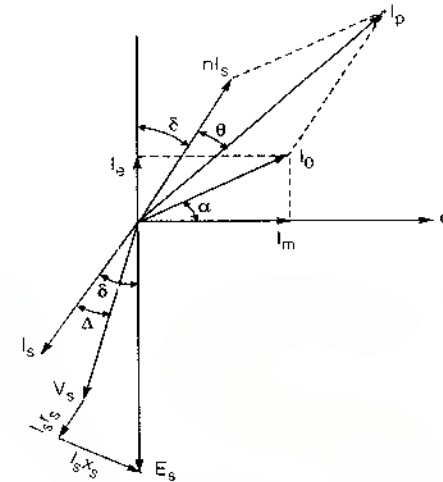

Phasor diagram of C.T.

□ Transformation ratio

$$R = \frac{I_p}{I_s} = n + \frac{I_o}{I_s} \sin(\delta + \alpha)$$

$$R \approx n + \frac{(I_m \sin \delta + I_e \cos \delta)}{I_s}$$

$$R \approx n + \frac{I_e}{I_s} \approx n \left(1 + \frac{I_e}{I_p} \right)$$

- where, $I_m = I_o \cos \alpha$
- $I_e = I_o \sin \alpha$

□ Phase angle

$$\theta \approx \frac{180}{\pi} \left(\frac{I_m \cos \delta - I_e \sin \delta}{n I_s} \right) \text{ degree}$$

$$\theta \approx \frac{180}{\pi} \frac{I_m}{I_p} \text{ degree}$$

□ Ratio error

$$\text{Ratio error} = \frac{\text{nominal ratio } (K_n) - \text{actual ratio } (R)}{\text{actual ratio } (R)}$$

Remember:

- The primary current of C.T. is depending on load connected to system but it is not depending secondary winding burden.
- Primary winding is single turn or bar winding and secondary has more number of turns to reduce the current at secondary.
- If primary current is very high, it causes reduction in ratio error and phase angle error. So to increase value of primary current the primary is maintain with single turn.
- The secondary number of turns are reduce by 1 or 2 turns then the ratio error reduces.

Potential transformer

- Actual transformation (voltage) ratio

$$R = n + \frac{I_s}{n} \left[\frac{R_p \cos \Delta + X_p \sin \Delta}{V_s} \right] + I_e r_p + I_m X_p$$

- Phase angle

$$\theta = \frac{I_s}{V_s} (X_s \cos \Delta - R_s \sin \Delta) + \frac{I_e X_p - I_m r_p}{n V_s} \text{ rad.}$$

Note:

- C.T. never operates with secondary winding open but P.T. can be operated with secondary winding open.
- Strip wound core is used to reduce ratio error and phase angle error.

Application of C.T. and P.T.

- Multiple operation with a single device.
- Higher current and higher voltages are step down to lower current and lower voltage so that metering is easier.
- Measuring circuit is isolated from the power circuit.
- Low power consumption.
- Replacement is easier.

**Measurement of Power and Wattmeters****Measurement of Power****1. D.C. Circuits**

- Ammeter connected between load and voltmeter

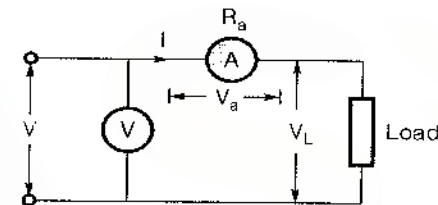

Power consumed by load:

$$P = VI - I^2 R_a$$

where, V = Voltage across voltmeter
 I = Current through ammeter
 R_a = Resistance of ammeter

- Voltmeter connected between load and ammeter

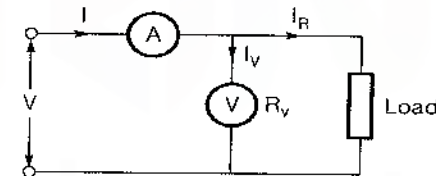

Power consumed by load:

$$P = VI - \frac{V^2}{R_v}$$

where, V = Voltage across voltmeter
 I = Current through ammeter
 R_v = Resistance of voltmeter

2. A.C. Circuits

□ Instantaneous power

$$p = vi = V_m I_m \sin \omega t \cdot \sin(\omega t - \phi)$$

where, $v = V_m \sin \omega t$

$i = I_m \sin(\omega t - \phi)$

□ Average power

$$P = VI \cos \phi = \frac{V_m I_m}{2} \cos \phi$$

where, V, I = Rms values of voltage and current

$\cos \phi$ = Power factor of the load

□ Let $v = V_o + \sum_{n=1}^m V_n \sin(n\omega t + \theta_n)$ and $i = I_o + \sum_{n=1}^m I_n \sin(n\omega t + \phi_n)$

then
$$P_{avg.} = V_o I_o + \frac{1}{2} \sum_{n=1}^m V_n I_n \cos[\theta_n - \phi_n]$$

Remember:

Wattmeter reads average active power.

electrodynamometer wattmeter

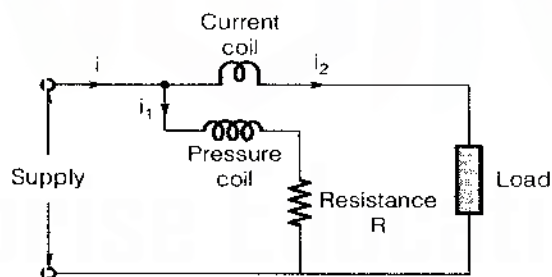

□ Instantaneous torque

$$T_i = i_1 i_2 \left(\frac{dM}{d\theta} \right)$$

where i_1, i_2 = instantaneous value of current in pressure and current coils

□ Deflecting torque

$$T_d = \frac{VI}{R_p} \cos \phi \cdot \frac{dM}{d\theta}$$

where, R_p = resistance of pressure coil circuit

□ Controlling torque

$$T_c = K\theta$$

where K = spring constant

θ = final steady deflection

□ Deflection

$$\theta = \left(K_1 \frac{dM}{d\theta} \right) P$$

where, P = power being measured = $VI \cos \phi$

$$K_1 = \frac{1}{R_p K}$$

Note:

Scale is linear in terms of power as $\theta \propto P$.

Errors in Electro-dynamometer Wattmeters

Correction Factor (K)

The correction factor is a factor by which the actual wattmeter reading is multiplied to get the true power.

□ For lagging power factor

$$K = \frac{\cos \phi}{\cos \beta \cos(\phi - \beta)}$$

□ For leading power factor

$$K = \frac{\cos \phi}{\cos \beta \cos(\phi + \beta)}$$

where, ϕ = Angle between current in the current coil and voltage of pressure coil

β = Angle between current and voltage of pressure coil

True power = Correction factor × actual wattmeter reading

□ For β very small

Actual wattmeter reading = true power (1 + tan φ tan β)

Error = tan φ tan β × true power = VI sin φ tan β

%error = tan φ tan β × 100

True power = VI cos φ

where, V = Voltage applied to pressure coil
I = Current in current coil

Power in Poly-Phase Systems

Blondel's Theorem

If a network is supplied through n conductors, the total power is measured by summing the reading of n wattmeters so arranged that a current element of a wattmeter is in each line and the corresponding voltage element is connected between that line and a common point, if the common point is located on one of the lines, then the power may be measured by (n - 1) wattmeters.

Two wattmeter method

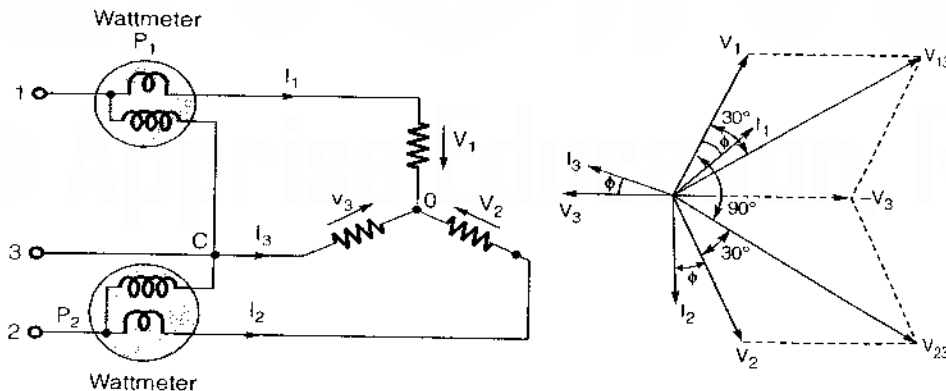

□ Reading of P₁ wattmeter

$P_1 = \sqrt{3} VI \cos(30^\circ - \phi)$

□ Reading of P₂ wattmeter

$P_2 = \sqrt{3} VI \cos(30^\circ + \phi)$

□ Total power consumed by load

$P = P_1 + P_2$

□ Power factor

$\cos \phi = \cos \left[\tan^{-1} \left(\sqrt{3} \frac{P_1 - P_2}{P_1 + P_2} \right) \right]$

$\tan \phi = \sqrt{3} \frac{P_1 - P_2}{P_1 + P_2}$

where, V = Phase voltage
I = Phase current
φ = Angle between phase current and phase voltage

Reading of Wattmeter at Different Power Factor

S.No.	φ	cos φ	P ₁	P ₂	P = P ₁ + P ₂	Comment
1.	0	1	$\frac{\sqrt{3}}{2} V_L I_L$	$\frac{\sqrt{3}}{2} V_L I_L$	$\sqrt{3} V_L I_L$	P ₁ = P ₂ (equal reading)
2.	30°	0.866	V _L I _L	$\frac{V_L I_L}{2}$	1.5 V _L I _L	P ₁ = 2P ₂
3.	60°	0.5	$\frac{\sqrt{3}}{2} V_L I_L$	0	$\frac{\sqrt{3}}{2} V_L I_L$	P ₂ = 0, P ₂ = P
4.	90°	0	$+\frac{V_L I_L}{2}$	$-\frac{V_L I_L}{2}$	0	P ₁ = -P ₂

Note: When wattmeter reading comes into negative, reverse either P.C. or C.C. terminal and then take the reading of negative wattmeter.

Measurement of Energy

For the measurement of energy, we use energy meter. Energy meter is an integrating instrument which adds the energy cumulatively over a period of time.

$$\text{Energy} = \text{Power} \times \text{time}$$

$$\text{Energy} = \int_0^t P \cdot dt \quad \text{kWhr}$$

Note:

- Energy meter works on principle of induction motor.
- The meter which measure A.C. energy is called watt hour meter.
- The meter which measure D.C. energy is called amp-hour meter.

□ Deflection torque

$$T_D \propto P$$

□ Breaking torque

$$T_B \propto N$$

where, N = Speed of disc in rps

□ At balance

$$T_d = T_B$$

$$\int P \cdot dt = K \int N \cdot dt$$

$$\text{Energy} \propto \int N \cdot dt$$

□ Energy meter constant (EMC)

$$\text{EMC} = \frac{\text{Number of revolution made by disc}}{\text{Energy recorded in kWhr}}$$

$$K = \frac{N}{P \times t}$$

where,
 P = Power in kW
 t = Time in hrs.

$$\square \% \text{ Creeping Error} = \frac{\text{Revolution of disc due to creeping per hour}}{\text{Revolution of disc due to total load per hour}} \times 100$$

Remember:

Potential coil of energy meter should be highly inductive so that it measures true energy.

Compensation in Energy Meter

1. **Lag compensation** : Through lag coil or shading coil.
2. **Low load or friction adjustment** : By using shading loop.
3. **Over friction or creeping** : By providing holes or slots on rotating disc.
4. **Over load compensation** : By keeping saturable shunt magnet in series magnet or current coil.
5. **Over voltage compensation** : By keeping saturable shunt magnet in shunt magnet.
6. **Temperature compensation** : By making permanent magnet of "mutemp" material.
7. **Speed adjustment** : By adjusting position of break magnet.

Remember:

- Creeping error is always positive.
- If either potential coil or current coil is wrongly connected then the disc rotates in opposite direction.



Measurement of Resistance



Classification of Resistance

- Low resistance:** All resistance of the order of 1Ω and below.
Example: Winding coils of electrical motors, generators and transformers.
- Medium resistance:** Resistances from 1Ω upwards to about $0.1 M\Omega$
Example: Resistance of heaters, potentiometers.
- High resistance:** All resistances of the order of $0.1 M\Omega$ and above.
Example: Insulation of electrical cable and windings, insulation of motors, generators and transformers.

Measurement of Medium Resistance

The different methods employed are:

- Ammeter-voltmeter method
- Wheatstone bridge method
- Ohmmeter method
- Substitution method

1. Ammeter Voltmeter Method

$$R_m = \frac{\text{voltmeter reading } - V}{\text{ammeter reading } - I}$$

where, R_m = measured value of resistance

(a) Circuit for higher resistance

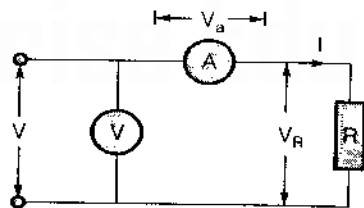

True value of resistance

$$R = R_{m1} - R_a$$

$$R_m = R_{m1} \left(1 - \frac{R_a}{R_{m1}} \right)$$

where, R_{m1} = Measured value of resistance

R_a = Resistance of ammeter

Relative error

$$\epsilon_r = \frac{R_{m1} - R}{R} = \frac{R_a}{R}$$

- To get minimum error, the test resistance should be more than the ammeter resistance so that this adjustment is suitable for measurement of high resistance.

(b) Circuit for lower resistance

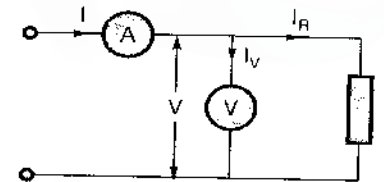

True value of resistance

$$R = \frac{R_{m2} R_v}{R_v - R_{m2}}$$

where, R_{m2} = Measured value of resistance

R_v = Resistance of voltmeter

For $R_v \gg R_{m2}$

$$R = R_{m2} \left(1 + \frac{R_{m2}}{R_v} \right)$$

Relative error

$$\epsilon_r = \frac{R_{m2} - R}{R} = \frac{-R_{m2}^2}{R_v R} \quad \left[\text{For } R_v \gg R_{m2} \right]$$

□ Approximate relative error

$$\epsilon = -\frac{R}{R_v} \quad \left[\text{For } R_{m2} \approx R \right]$$

- This circuit is suitable for measurement of low resistance under medium scale range to get minimum error.

Note:

Relative errors for above two cases are equal when true value of resistance,

$$R = \sqrt{R_a R_v}$$

2. Wheatstone Bridge

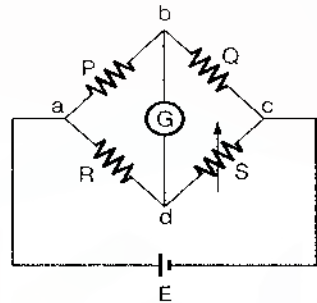

□ At balance

$$R = S \frac{P}{Q}$$

□ Sensitivity of Wheatstone bridge

$$S_B = \frac{\theta}{\Delta R/R} = \frac{S_v ESR}{(R+S)^2} \quad ; \text{ mm}$$

$$S_B = \frac{S_v E}{\frac{P}{Q} + 2 + \frac{Q}{P}}$$

where, S_v = Voltage sensitivity of galvanometer, mm/volt

E = Bridge voltage

P, Q = Branch resistances

θ = Deflection of galvanometer, mm

□ For a bridge with equal arms

$$S_B = \frac{S_v E}{4}$$

Note:

- For maximum bridge sensitivity

$$\frac{P}{Q} = \frac{R}{S} = 1$$

- Sensitivity of bridge is most important parameter as compared to accuracy, precision and resolution.

Equivalent circuit of Wheatstone bridge

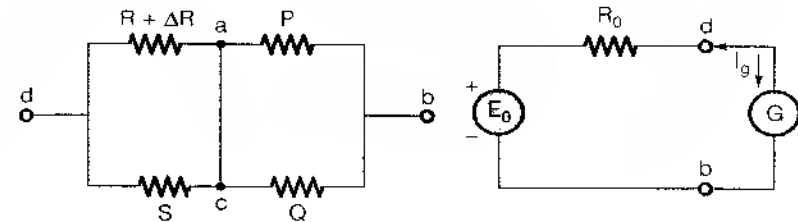

□ Galvanometer current

$$I_g = \frac{E_0}{R_0 + G}$$

where E_0 = Thevenin's or open circuit voltage appearing between terminals b and d with galvanometer circuit open circuited.

G = Resistance of the galvanometer circuit

$$E_0 = E \left[\frac{R + \Delta R}{2R + \Delta R} - \frac{1}{2} \right] \approx E \left(\frac{\Delta R}{4R} \right) \quad \text{as } \Delta R \ll R$$

ΔR = Change in resistance R

□ Thevenin equivalent resistance of bridge

$$R_0 = \frac{RS}{R+S} + \frac{PQ}{P+Q}$$

Galvanometer deflection

$$\theta = \frac{S_v E S \Delta R}{(R+S)^2} = \frac{S_1 E S \Delta R}{(R_0 + G)(R+S)^2}$$

where, S_1 = Current sensitivity of galvanometer

Bridge sensitivity

$$S_B = \frac{\theta}{\Delta R/R} = \frac{S_1 E S R}{(R_0 + G)(R+S)^2}$$

Current Sensitivity

$$S_i = \frac{\theta}{I_g}; \text{ mm}/\mu\text{A}$$

θ = Deflection in galvanometer

I_g = Current in galvanometer

Voltage Sensitivity

$$S_v = \frac{\theta}{V_{Th}}; \text{ mm}/\text{V}$$

V_{Th} = Voltage across galvanometer

Note:

In Wheatstone bridge method, the effect of lead resistance is not eliminated hence it is not suitable for measurement of low resistance.

3. Ohmmeters

(a) Series Type Ohmmeter

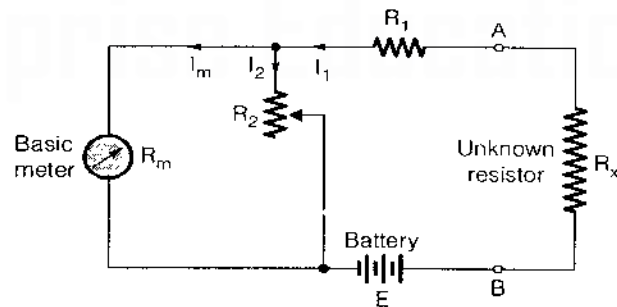

Half scale resistance

$$R_h = R_1 + \frac{R_2 R_m}{R_2 + R_m}$$

Meter current

$$I_m = \frac{E R_2}{(R_h + R_x)(R_2 + R_m)}$$

Full scale deflection current

$$I_{fs} = \frac{E R_2}{R_h(R_2 + R_m)}$$

Friction of full scale reading

$$s = \frac{I_m}{I_{fs}} = \frac{R_h}{R_x + R_h}$$

(b) Shunt Type Ohmmeter

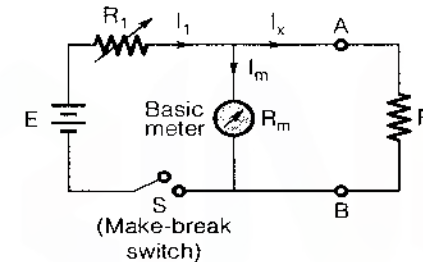

Half scale reading of unknown resistance R_x is

$$R_h = \frac{R_1 R_m}{R_1 + R_m}$$

Half scale reading of the meter

$$I_h = 0.5 I_{fs} = \frac{E R_h}{R_1 R_m + R_h(R_1 + R_m)}$$

where, R_m = Internal resistance of meter

R_1 = Adjustable resistor (as shown in figure)

E = Supply voltage

Measurement of low Resistance

The different methods employed are:

- (i) Kelvin's double bridge method
- (ii) Ammeter vollmeter method
- (iii) Potentiometer method

Kelvin's Double Bridge Method

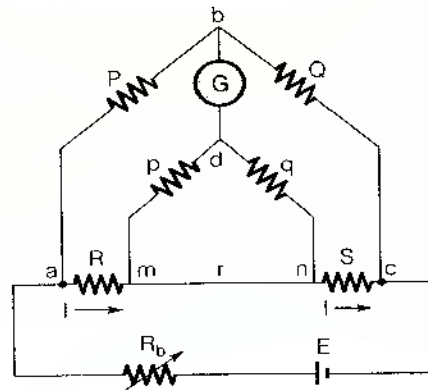

□ For zero galvanometer deflection

$$E_{ab} = E_{amd}$$

$$R = \frac{P}{Q} \cdot S + \frac{qr}{p+q+r} \left[\frac{P}{Q} - \frac{p}{q} \right]$$

□ If $\frac{P}{Q} = \frac{p}{q}$

then

$$R = \frac{P}{Q} \cdot S$$

Note:

Accuracies by Kelvin double bridge method

- (i) From $1000 \mu\Omega$ to 1.0Ω : 0.05%
- (ii) From $100 \mu\Omega$ to $1000 \mu\Omega$: 0.5% to 0.05%
- (iii) From $10 \mu\Omega$ to $100 \mu\Omega$: 0.5% to 0.2%

Measurement of High Resistance

The difference methods employed are:

- (i) Loss of charge method
- (ii) Meggar
- (iii) Direct deflection method
- (iv) Megohm bridge

1. Loss of Charge Method

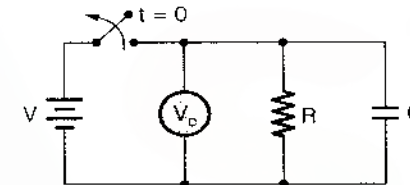

$$R = \frac{0.4343 t}{C \log_{10} \left(\frac{V_i}{V_c} \right)}$$

2. Meggar

- Meggar works on the principle of electro-dynamometer.
- Meggar is used to measure the insulation resistance of cable, motor and generator, etc.
- Deflecting torque angle is proportional to the resistance of the insulator, which is under test.
- It is also used to check the continuity of cable.
- No external control torque provided.
- Air friction damping is used.
- No need of external power supply.

Note:

High resistance have a guard terminal which is used to avoid leakage current.

Carry Foster Slide Wire Bridge

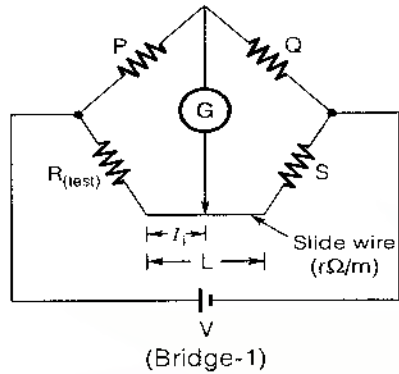

From bridge (1)

$$\frac{P}{Q} + 1 = \frac{R + S + Lr}{S + (L - l_1)r} \quad \dots (i)$$

Equating equation (i) and (ii)

$$R - S = (l_2 - l_1)r$$

Note:

Carry Foster bridge method is used for medium resistance measurement by comparing with standard resistance.

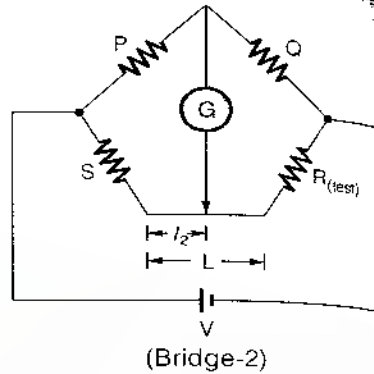

From bridge (2)

$$\frac{P}{Q} + 1 = \frac{R + S + Lr}{R + (L - l_2)r} \quad \dots (ii)$$

C. Bridges

Introduction

Used to measure self inductance, Mutual inductance, capacitance, and frequency.

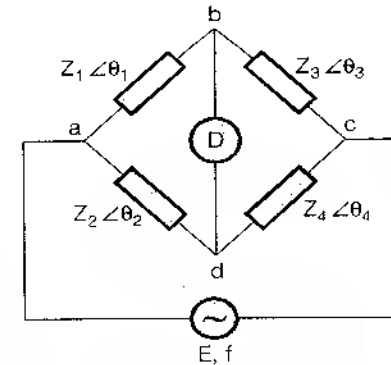

□ General equation for bridge balance

$$\bar{Z}_1 \bar{Z}_4 = \bar{Z}_2 \bar{Z}_3$$

□ Magnitude condition

$$|Z_1| |Z_4| = |Z_2| |Z_3|$$

□ Angle condition

$$\angle \theta_1 + \angle \theta_4 = \angle \theta_2 + \angle \theta_3$$

Note:

Magnitude condition and angle condition both must be satisfied for the bridge to be balanced.

□ Depending upon the frequency, different null detectors are used

- Vibration galvanometer – 5 Hz to 1 kHz
- Head phones – 250 Hz to 4 kHz
- Tuned amplifier detector – 10 Hz to 100 kHz
- D'Arsonval Galvanometer – DC frequency = 0 Hz

□ Depending upon phase angle θ , elements are

θ	Elements
0°	R
90°	L_1
-90°	C_1
$0^\circ < \theta_1 < 90^\circ$	R_1, L_1
$-90 < \theta_1 < 0^\circ$	R_1, C_1

□ Convergence to balance point:

If the variables are in the same arm of bridge then minimum time is required for balancing of bridge. This is called convergence to balance point.

□ Quality factor (Q.F.)

$$Q.F. = \frac{\text{Energy stored}}{\text{Energy dissipated}}$$

Measurement of Self Inductance

1. Maxwell's Inductance Bridge

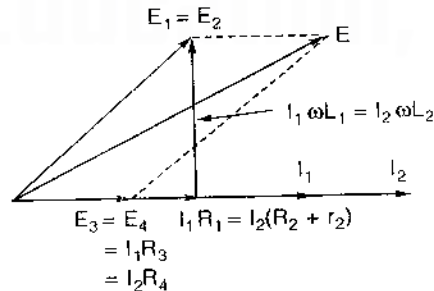
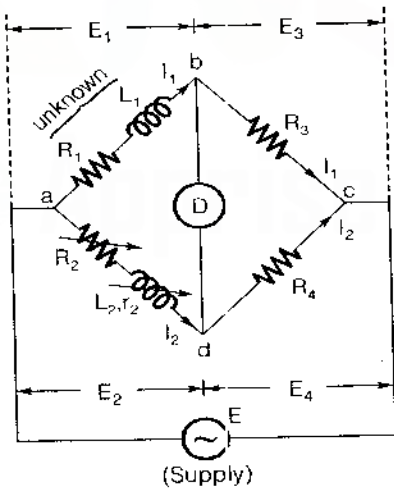

$$R_1 = \frac{R_3}{R_4} (R_2 + r_2)$$

$$L_1 = \frac{R_3}{R_4} L_2$$

where, L_1 = Unknown inductance of resistance R_1

L_2 = Variable inductance of fixed resistance r_2

R_2 = Variable resistance connected in series with L_2

R_3, R_4 = Known non-inductive resistances

2. Maxwell's Inductance-Capacitance Bridge

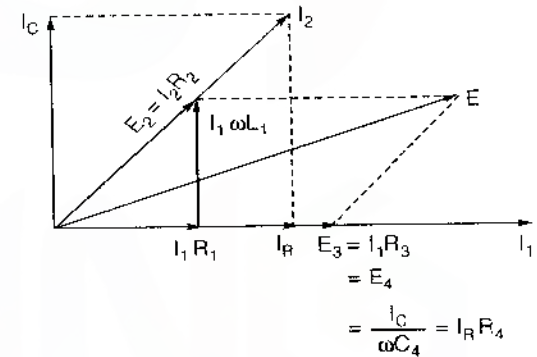
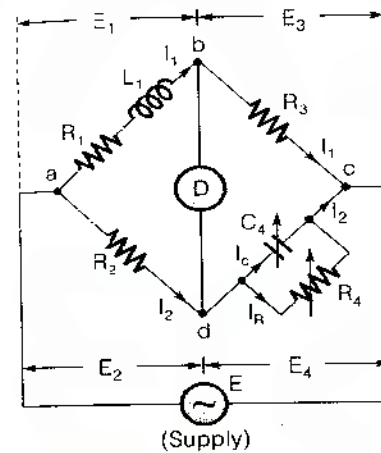

$$R_1 = \frac{R_2 R_3}{R_4}$$

and

$$L_1 = R_2 R_3 C_4$$

□ Q factor of the coil

$$Q = \frac{\omega L_1}{R_1} = \omega C_4 R_4$$

Note:

- Not suitable for measurement of high Q coil because phase angle criteria does not satisfy.

- Not suitable for measurement of low Q-coil because of sliding balance problem.
- Suitable for measurement of medium Q coil i.e. (1 < Q < 10).

3. Hay's Bridge

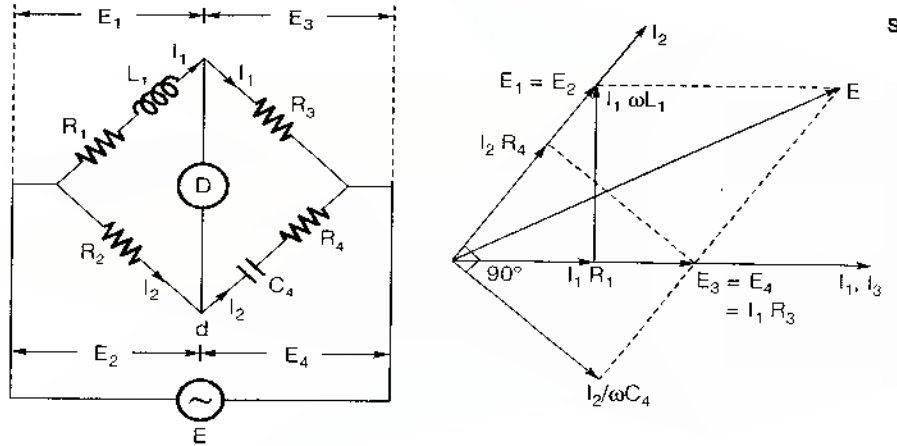

$$R_1 = \frac{\omega^2 R_2 R_3 R_4 C_4^2}{1 + \omega^2 C_4^2 R_4^2} = \frac{R_2 R_3}{R_4} \left(\frac{1}{1 + Q^2} \right)$$

$$L_1 = \frac{R_2 R_3 C_4}{1 + \omega^2 C_4^2 R_4^2} = \frac{R_2 R_3 C_4}{1 + \left(\frac{1}{Q} \right)^2}$$

□ For Q > 10

$$L_1 = R_2 R_3 C_4$$

$$Q = \frac{\omega L_1}{R_1} = \frac{1}{\omega C_4 R_4}$$

where, L_1 = Unknown-inductance having a resistance R_1
 R_2, R_3, R_4 = known non-inductive resistance
 C_4 = Standard capacitor

Note:
 The Hay's bridge is suited for the measurement of high Q inductors.

4. Anderson's Bridge

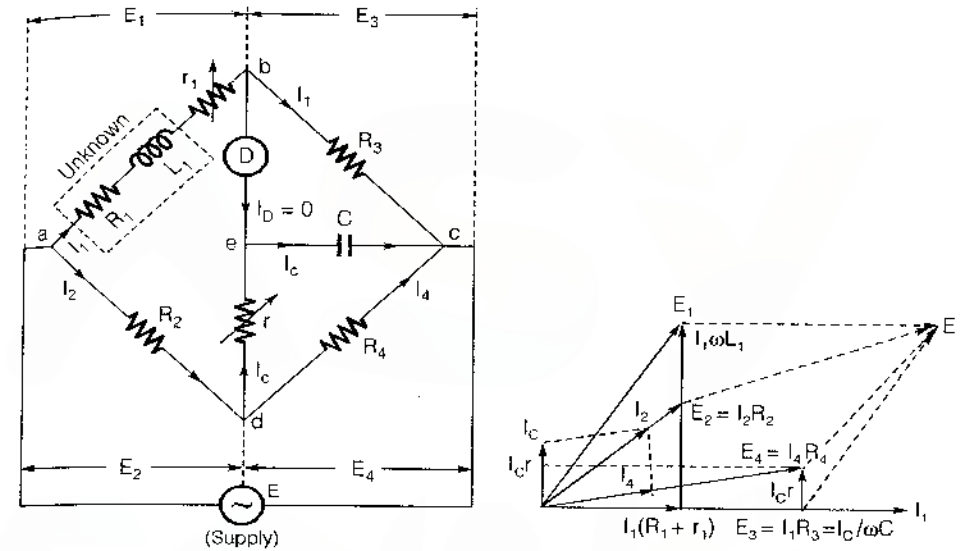

$$R_1 = \frac{R_2 R_3}{R_4} - r$$

$$L_1 = \frac{C R_3}{R_4} [r(R_4 + R_2) + R_2 R_4]$$

where, L_1 = Self-inductance to be measured
 R_1 = Resistance of self-inductor
 r = Resistance connected in series with self-inductor
 r, R_2, R_3, R_4 = Known non-inductive resistances
 C = Fixed standard capacitor

5. Owen's Bridge

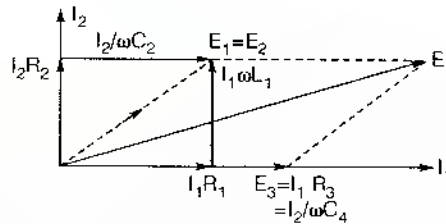
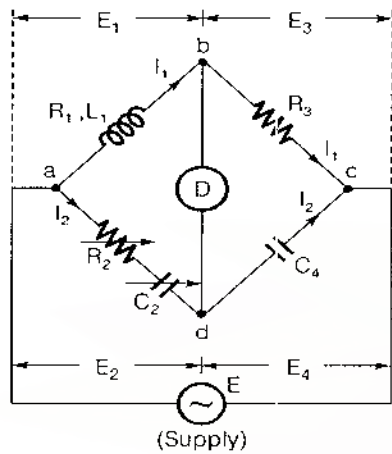

$$L_1 = R_2 R_3 C_4$$

$$R_1 = R_3 \frac{C_4}{C_2}$$

- where, L_1 = Unknown self inductance of resistance R_1
 R_2 = Variable non-inductive resistance
 R_3 = Fixed non-inductive resistance
 C_2 = Variable standard capacitor
 C_4 = Fixed standard capacitor

Note: Owen's bridge is used for measurement of unknown inductance and incremental inductance and incremental permeability (μ).

Measurement of Incremental Inductance

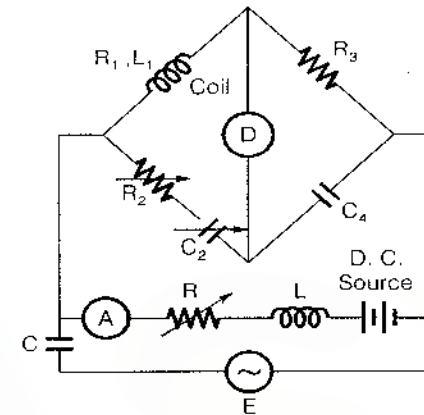

Incremental inductance

$$L_1 = R_2 R_3 C_4$$

Incremental permeability

$$\mu = \frac{L_1 l}{N^2 A}$$

- where, N = Number of turns
 A = Area of flux path
 l = Length of flux path
 R_2 = Variable non-inductive resistance
 R_3 = Fixed non-inductive resistance
 C_4 = Fixed standard capacitor

Note:

- External D.C. source is used to compensate residual magnetism.
- Capacitor, C is to block D.C. to enter into A.C. and inductor, L is to block A.C. to enter into D.C.

Measurement of Capacitance

1. De Sauty's Bridge

(a) For lossless capacitor

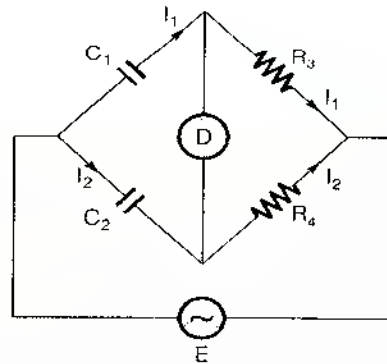

$$C_1 = \frac{C_2 R_4}{R_3}$$

where, C_1 = Capacitor whose capacitance to be measured
 C_2 = A standard capacitor
 R_3, R_4 = Non-inductive resistors

(b) For imperfect capacitor having dielectric loss

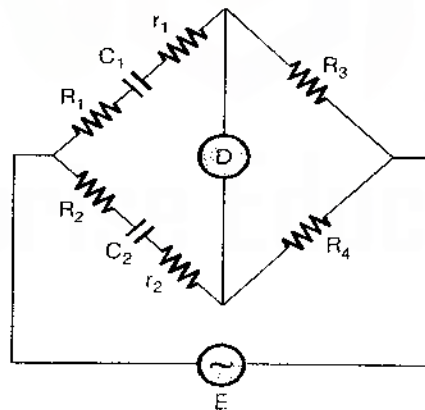

$$\frac{C_1}{C_2} = \frac{R_4}{R_3} = \frac{R_2 + r_2}{R_1 + r_1}$$

where, r_1, r_2 = Resistance representing the loss component of the two capacitor.

□ Dissipation factor

$$D = \tan \delta = \omega C_1 r_1 = \omega C_2 r_2$$

2. Schering Bridge

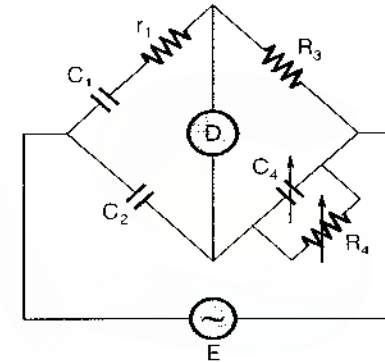

$$r_1 = \frac{R_3 C_4}{C_2}$$

$$C_1 = C_2 \left(\frac{R_4}{R_3} \right)$$

□ Dissipation factor

$$D = \omega C_1 r_1 = \omega C_4 \frac{R_4}{R_3}$$

where, C_1 = Capacitor whose capacitance is to be determined
 r_1 = Series resistance representing the loss in the capacitor C_1
 C_2 = Standard loss-free capacitor
 R_3 = Non-inductive resistance
 C_4 = Variable capacitor
 R_4 = Variable non-inductive resistance in parallel with variable capacitor C_4

Note:

Schering bridge is shielded with metal screen to reduce the stray capacitance exists between the arms and arms to the earth.

Measurement of Frequency

Wien's Bridge

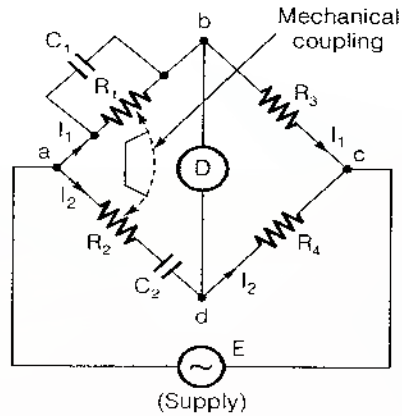

□ Frequency

$$\frac{R_4}{R_3} = \frac{R_2}{R_1} + \frac{C_1}{C_2}$$

$$f = \frac{1}{2\pi\sqrt{R_1 R_2 C_1 C_2}} \text{ Hz}$$

□ For $R_1 = R_2 = R$ and $C_1 = C_2 = C$

$$f = \frac{1}{2\pi RC}$$

$$\frac{R_4}{R_3} = 2$$

Limitation of Wien's Bridge

If the input signal is not a sinusoidal or signal containing harmonics then balancing of bridge is not possible because null detector is sensitive to the frequencies.



Magnetic Measurements

9

□ Flux density

$$B = \frac{\phi}{A_s} = \frac{RK_q \theta_1}{2NA_s}$$

where, ϕ = Flux linking search coil
 A_s = Cross-sectional area of specimen
 R = Resistance of the ballistic galvanometer circuit
 $K_q \theta_1$ = Charge indicated by ballistic galvanometer
 N = Number of turns in the search coil

□ Hysteresis loss per unit volume

$$p_h = \eta f B_m^k$$

where, η = Hysteresis coefficient
 f = Frequency; Hz
 B_m = Maximum flux density; Wb/m²
 k = Steinmetz coefficient

Note:

The value of k varies from 1.6 to 2.

□ Eddy current loss per unit volume for laminations

$$p_e = \frac{4k_f^2 f^2 B_m^2 t^2}{3\rho}$$

where, k_f = Form factor
 t = Thickness of laminations; m
 ρ = Resistivity of material; $\Omega\text{-m}$

□ Total iron loss per unit volume

$$p_i = p_h + p_e = \eta f B_m^k + \frac{4k_f^2 f^2 B_m^2 t^2}{3\rho}$$

- Maximum flux density

$$B_m = \frac{E_2}{4k_f f A_s N_2}$$

- For sinusoidal supply

$$B_m = \frac{E_2}{4.44 f A_s N_2}$$

where, E_2 = Voltage induced in secondary winding
 $E_2 = 4k_f f \phi_m N_2$
 k_f = Form factor (= 1.11 for sinusoidal supply)
 f = Frequency
 A_s = Cross-sectional area of specimen
 N_2 = Number of turns in secondary winding
 ϕ_m = Maximum flux linkage

■■■■

Electronic Instruments

- Average current through diode vacuum tube voltmeters

$$I_{av} = \frac{E_{av}}{2R} = \frac{E_{rms}}{2 \times 1.11 \times R} = 0.45 \frac{E_{rms}}{R}$$

where, E_{rms} = RMS value of applied voltage
 E_{av} = Average value of applied voltage
 R = Load resistance

Difference amplifier type of electronic voltmeter

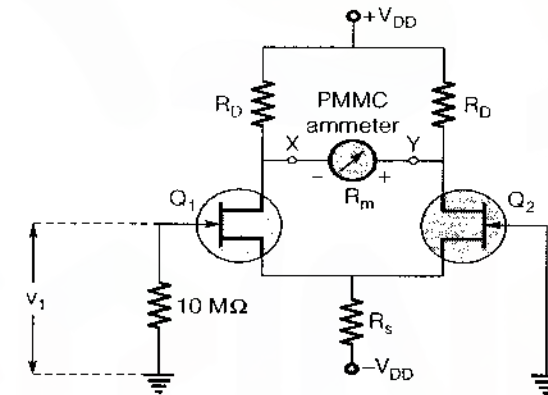

- Thevenin's voltage across terminal X-Y

$$V_{Th} = g_m \left(\frac{r_d R_D}{r_d + R_D} \right) V_1$$

- Thevenin's resistance looking into terminals X-Y

$$R_{Th} = \frac{2r_d R_D}{r_d + R_D}$$

where, R_D = A.C. drain resistance in Ω
 g_m = Transconductance in mho

- Current through ammeter

$$i = \frac{V_{Th}}{R_{Th} + R_m} = \frac{g_m r_d R_D / (r_d + R_D)}{2r_d R_D / (r_d + R_D) + R_m} \cdot v_1$$

when $R_D \ll r_d$

$$i = \frac{g_m R_D}{2R_D + R_m} \cdot v_1$$

Digital Meters

Basic measurable quantity in digital meter is D.C.

1. Resolution (R) of Digital Meter

The smallest change in the input which a digital meter can be able to detect is called resolution.

$$R = \frac{1}{10^n}$$

where, n = Number of full digit.

2. Sensitivity (S)

The smallest change in input that can be displayed within given range.

$$S = \text{Resolution} \times \text{Range of meter}$$

3. Over ranging

Switch on the extra half (1/2) is called over ranging. Due to this over ranging the range of the instrument increases.



Cathode Ray Oscilloscope

11

CRO is a digital instrument, which works on the principle of thermionic emission i.e. emission of electron from a heated surface. It is a linear device. With the use of CRO one can measure peak to peak, rms, peak or average value of voltage and current.

- Calibration of CRO

Calibration of CRO is done by applying a known quality of square signal having a frequency of 1 kHz and peak to peak magnitude of 1 mV.

- The rise time (t_r), of signal applied to CRO and bandwidth of CRO are related as

$$t_r \times \text{B.W.} = 0.35$$

If this condition fails then the signal is distorted at the output of CRO.

- Electrostatic Deflection

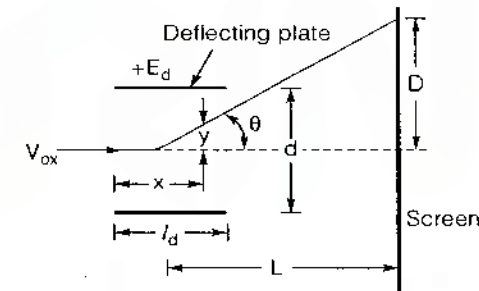

$$y = \frac{1}{2} \frac{e \cdot E_y}{m v_{ox}^2} x^2$$

where, y = Displacement in y-direction; m

e = Charge of an electron; Coulomb

E_y = Electric field intensity in Y-direction; V/m

m = Mass of electron; kg

v_{ox} = Velocity of electron when entering the fields of deflecting plates; m/s
 x = Displacement in x-direction ; m

Deflection

$$D = \frac{L I_d E_d}{2d E_a}$$

where, L = Distance between screen and the centre of deflecting plates; m

I_d = Length of deflecting plates; m
 E_d = Potential between deflecting plates; V
 d = Distance between deflecting plates; m
 E_a = Voltage of pre-accelerating anode; V

Deflection sensitivity

$$S = \frac{D}{E_d} = \frac{L I_d}{2d E_a} \text{ m/V}$$

Deflection factor

$$G = \frac{1}{S} = \frac{2d E_a}{L I_d} \text{ V/m}$$

Sawtooth Generator

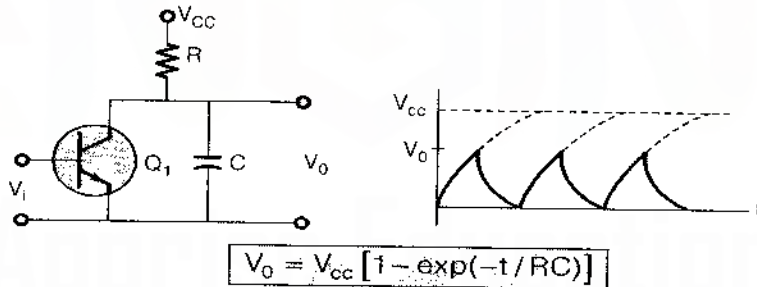

where, V_0 = Instantaneous voltage across the capacitor at time t ; V
 V_{cc} = Supply voltage

Lissajous patterns

If horizontal and vertical deflecting plate are applied with sinusoidal signal, the waveform pattern appearing on the screen is called Lissajous pattern.

Application

- Used for finding the phase angle difference between the signal applied to vertical and horizontal plate.
- Used for finding the frequency ratio between vertical and horizontal plates voltage.

Phase angle (ϕ) between V_x and V_y	Lissajous pattern
0° or 360°	
$0^\circ < \phi < 90^\circ$ (or) $270^\circ < \phi < 360^\circ$	
$\phi = 90^\circ$ or 270°	
$90^\circ < \phi < 180^\circ$ (or) $180^\circ < \phi < 270^\circ$	
$\phi = 180^\circ$	

Finding the phase angle ϕ from given Lissajous pattern

(a) When Lissajous pattern is in first and third quadrant

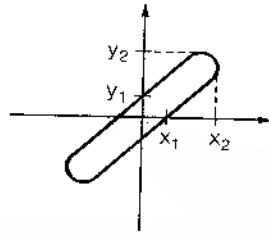

□ First possibility

$$\phi = \sin^{-1}\left(\frac{x_1}{x_2}\right) = \sin^{-1}\left(\frac{y_1}{y_2}\right)$$

□ Second possibility = $360^\circ - \phi$

(b) When Lissajous pattern is in second and fourth quadrant

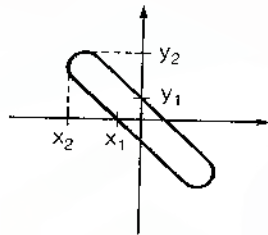

□ First possibility

$$\phi = 180^\circ - \sin^{-1}\left(\frac{x_1}{x_2}\right)$$

□ Second possibility = $360^\circ - \phi$

Measurement of Frequency Using Lissajous Pattern

$$\frac{f_y}{f_x} = \frac{\text{(number of intersections of the horizontal line with the curve)}}{\text{(number of intersections of the vertical line with the curve)}}$$

where, f_y = Frequency of signal applied to Y plates
 f_x = Frequency of signal applied to X plates



High Frequency Measurements

Q-meter

It works on the principle of series resonance.

Measurement of the Storage Factor Q

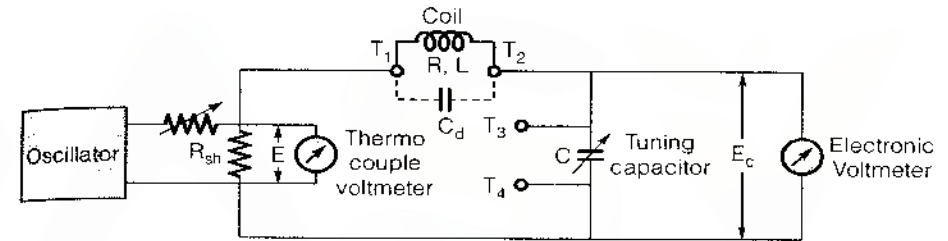

□ Resonant frequency of Q-Meter

$$f_0 = \frac{1}{2\pi\sqrt{LC}}$$

□ Measured value of Q

$$Q_m = \frac{\omega_0 L}{R + R_{sh}}$$

□ True value of Q

$$Q_t = \frac{\omega_0 L}{R}$$

$$Q_t = Q_m \left(1 + \frac{R_{sh}}{R}\right) = Q_m \left(1 + \frac{C_d}{C}\right)$$

where, R = Resistance of coil
 L = Inductance of coil
 R_{sh} = Shunt resistance
 C = Tuning capacitance
 C_d = Distributed or self-capacitance

□ Measurement of inductance

$$L = \frac{1}{4\pi^2 f_0^2 C}$$

- Measurement of effective resistance

$$R = \frac{\omega_0 L}{Q_t}$$

Measurement of Distributed or self-capacitance

- Resonance frequency

$$f_1 = \frac{1}{2\pi\sqrt{L(C_1 + C_d)}} \quad ; \quad f_2 = \frac{1}{2\pi\sqrt{L(C_2 + C_d)}}$$

when, $f_2 = n f_1$

then,
$$C_d = \frac{C_1 - n^2 C_2}{n^2 - 1}$$

where, C_1 = Tuning capacitance at frequency f_1
 C_2 = Tuning capacitance at frequency f_2

Measurement of Unknown Capacitance C_x

Adjust capacitor $C = C_1$ to get resonance frequency f_1 with unknown capacitance C_x in parallel.

$$f_1 = \frac{1}{2\pi\sqrt{L(C_x + C_1)}} \quad \dots(i)$$

Now remove C_x and again adjust $C = C_2$ to get same resonance frequency f_1

$$f_1 = \frac{1}{2\pi\sqrt{LC_2}} \quad \dots(ii)$$

By equating equation (i) and (ii),

$$C_x = C_2 - C_1$$

■■■■

Transducers

Strain Gauge

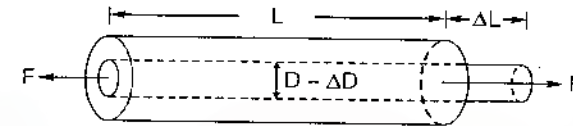

- Gauge factor of strain gauge

$$G_f = \frac{\Delta R/R}{\Delta L/L} = 1 + 2\nu + \frac{\Delta\rho/\rho}{\epsilon}$$

where, $\frac{\Delta\rho}{\rho}$ = Per unit change in resistivity

ν = Poisson's ratio

ϵ = Strain

- For $\frac{\Delta\rho}{\rho} \rightarrow 0$

$$G_f \approx 1 + 2\nu$$

- Poisson's ratio

$$\text{Poisson's ratio } (\nu) = \frac{\text{lateral strain}}{\text{longitudinal strain}} = \frac{-\partial D/D}{\partial L/L}$$

- Strain

$$\text{Strain } (\epsilon) = \frac{\Delta L}{L}$$

where, $\frac{\Delta L}{L}$ = Per unit change in length

Thermistor

- Resistance of thermistor

$$R_{T_1} = R_{T_2} \exp \left[\beta \left(\frac{1}{T_1} - \frac{1}{T_2} \right) \right]$$

where, R_{T_1} = Resistance of thermistor at absolute temperature T_1 ; °K

R_{T_2} = Resistance of thermistor at absolute temperature T_2 ; °K

β = A constant depending upon the material of thermistor

- Steinhart-Hart equation

$$\frac{1}{T} = A + B \ln R + C(\ln R)^3$$

where,

T = Temperature; °K,

R = Resistance of thermistor ; Ω

A, B, C = Curve fitting constant

- Thermistor resistance

$$R_T = aR_o \exp(b/T)$$

where, R_T, R_o = Resistance of thermistor at temperature T °K and ice point respectively

Thermocouple

- E.M.F. produced in a thermocouple

$$E = a(\Delta\theta) + b(\Delta\theta)^2$$

Where

$\Delta\theta$ = Difference in temperature between the hot thermocouple junction and the reference junction of thermocouple; °C

a, b = Constant

LVDT

- Sensitivity of LVDT

$$\text{Sensitivity} = \frac{\text{output voltage}}{\text{displacement}}$$

Capacitive Transducers**Capacitance**

- Capacitance of parallel plate capacitor

$$C = \frac{\epsilon A}{d} = \frac{\epsilon xw}{d}$$

where,

A = Overlapping area of plates

x = Length of overlapping part of plates

w = Width of overlapping part of plates

d = Distance between two plates

ϵ = Permittivity of medium

- Capacitance of cylindrical capacitor

$$C = \frac{2\pi\epsilon x}{\log_e(D_2/D_1)} \text{ F}$$

- Capacitance at angular displacement θ

$$C = \frac{\epsilon\theta r^2}{2d}$$

where, r = Radius of semi circular plate

θ = Angular displacement in radian

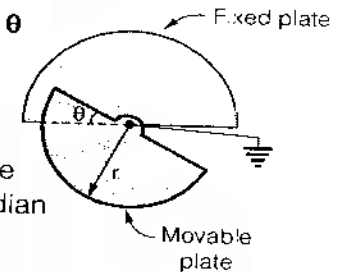
**Sensitivity**

- Sensitivity of parallel plate capacitive transducer

$$S = \frac{\partial C}{\partial x} = \epsilon \frac{w}{d}$$

where, x = Length of overlapping part of cylinders; m

D_2 = Inner diameter of outer cylindrical electrode; m

D_1 = Outer diameter of inner cylindrical electrodes; m

- Sensitivity of cylindrical capacitive transducer

$$S = \frac{2\pi\epsilon}{\log_e(D_2/D_1)} \text{ F/m}$$

- Sensitivity of variable capacitance transducer

$$S = \frac{\epsilon r^2}{2d}$$

Piezo-Electric Transducer

- Voltage sensitivity of crystal

$$g = \frac{\text{Electric field}}{\text{Stress}} = \frac{\epsilon}{P} \text{ Vm/N}$$

where, P = Pressure or stress; N/m²

- Charge sensitivity

$$d = \epsilon_r \epsilon_0 g \text{ C/N}$$

- Output voltage

$$E_o = gtp$$

where, t = Thickness of crystal ; m



A Handbook on Electrical Engineering

5

Network Theory

CONTENTS

1. Circuit Elements and Signal Waveform.....	290
2. Network Laws and Theorems.....	302
3. Graph Theory.....	309
4. Laplace Transform Analysis and Circuit Transients.....	313
5. Resonance.....	318
6. Magnetically Coupled Circuit.....	322
7. Two Port Network.....	325
8. Network Synthesis.....	329
9. Dual Network.....	333



Circuit Elements and Signal Waveform



Electrical Network Components

Resistor

It is the property of a substance due to which it opposes the flow of current (i.e. electrons) through it.

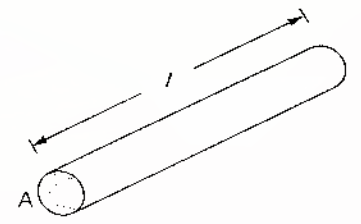

Resistance, $R = \rho \frac{l}{A}$, Ohm (Ω)

where, l = Length of conductor, metre (m)
 A = Area of cross-section, m^2
 ρ = Resistivity of the material, $\Omega\text{-m}$

- Note:**
- Extension of wire result into increase in resistance while compression of wire result into decrease in resistance.

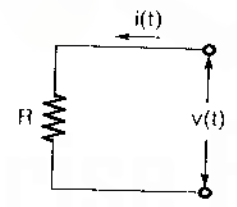

$v(t) = Ri(t)$
 $i(t) = \frac{1}{R} v(t)$... in time domain

$V(s) = RI(s)$
 $I(s) = \frac{1}{R} V(s)$... in s-domain

Power loss in resistor,

$$p = vi = i^2 R = \frac{v^2}{R}$$

Energy dissipated in resistor,

$$E_R = \int_{t_1}^{t_2} p dt$$

Combination of Resistors

1. Resistors in series

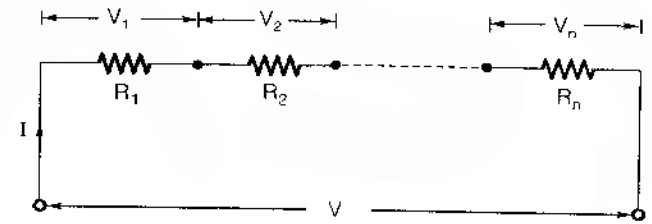

$$V = IR_{eq}$$

$$R_{eq} = R_1 + R_2 + \dots + R_n$$

2. Resistors in parallel

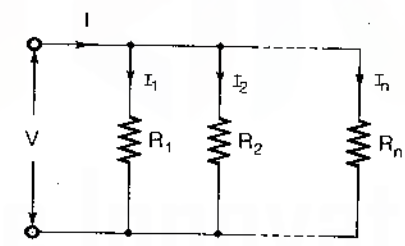

$$I = \frac{V}{R_{eq}}$$

$$\frac{1}{R_{eq}} = \frac{1}{R_1} + \frac{1}{R_2} + \dots + \frac{1}{R_n}$$

Capacitor

The circuit element that stores energy in an electric field is a capacitor or capacitance.

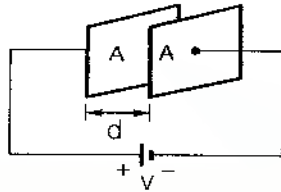

Capacitance

$$C = \frac{\epsilon_0 \epsilon_r A}{d}, \text{ Farad}$$

- where
- ϵ_0 = Permittivity of free space, F/m
 - ϵ_r = Relative permittivity of the dielectric
 - A = Cross-sectional area of parallel plates, m²
 - d = Separation of plates, m

Note:

- When the capacitance is removed from the source, the capacitor retains the charge and the electric field until a discharge path is provided.

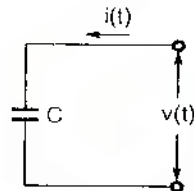

$$v(t) = \frac{1}{C} \int_0^t i(t) dt \quad \dots \text{in time domain}$$

$$i(t) = C \frac{dv(t)}{dt}$$

$$V(s) = \frac{1}{sC} I(s) \quad \dots \text{in s-domain}$$

$$I(s) = sCV(s)$$

$$Z_c(s) = \frac{1}{sC}$$

$$Y_c(s) = sC$$

Power in capacitance,

$$p = vi = Cv \frac{dv}{dt}$$

Energy stored in capacitance,

$$E_c = \frac{1}{2} Cv^2$$

Combination of Capacitors

1. Capacitors in series

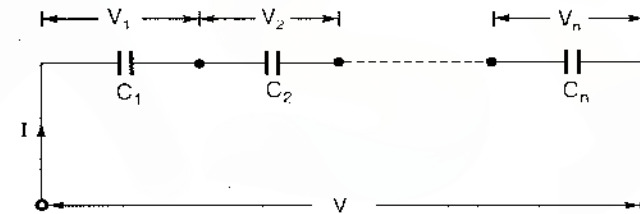

$$V = \frac{1}{C_{eq}} \int_0^t i dt$$

$$\frac{1}{C_{eq}} = \frac{1}{C_1} + \frac{1}{C_2} + \frac{1}{C_3} + \dots + \frac{1}{C_n}$$

2. Capacitors in parallel

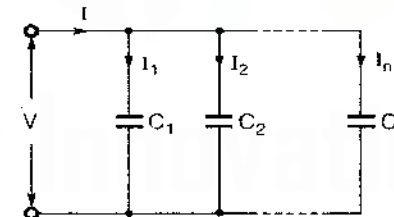

$$I = C_{eq} \frac{dv}{dt}$$

$$C_{eq} = C_1 + C_2 + C_3 + \dots + C_n$$

Inductor

The circuit element that stores energy in a magnetic field is an inductor or inductance.

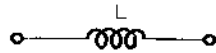

Inductance

$$L = \frac{\mu_0 N^2 A}{l}, \text{ Henry}$$

- where μ_0 = Permeability of free space, H/m
- N = Total number of turns in coil
- A = Cross-sectional area of coil, m^2
- l = Length of coil, m

Note:

- When the inductance is removed from the source, the magnetic field will collapse i.e. no energy is stored without a connected sources.

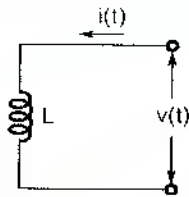

$$v(t) = L \frac{di(t)}{dt}$$

$$i(t) = \frac{1}{L} \int_0^{\infty} v(t) dt$$

... in time domain

$$V(s) = sL I(s)$$

$$I(s) = \frac{1}{sL} V(s)$$

... in s-domain

$$Z_L(s) = sL$$

$$Y_L(s) = \frac{1}{sL}$$

Power in inductance,

$$p = v i = L i \frac{di}{dt}$$

Energy stored in an inductance,

$$E_L = \frac{1}{2} L i^2$$

Combination of Inductor

1. Inductors in series

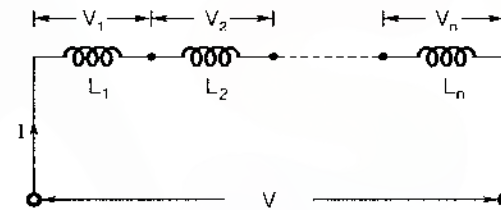

$$V = L_{eq} \frac{di}{dt} ; L_{eq} = L_1 + L_2 + L_3 + \dots + L_n$$

2. Inductors in parallel

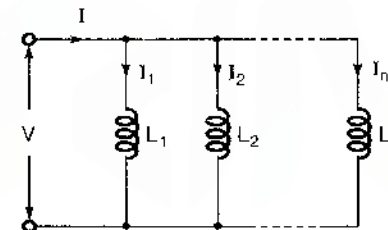

$$I = \frac{1}{L_{eq}} \int v dt ; \frac{1}{L_{eq}} = \frac{1}{L_1} + \frac{1}{L_2} + \frac{1}{L_3} + \dots + \frac{1}{L_n}$$

Ideal Transformer

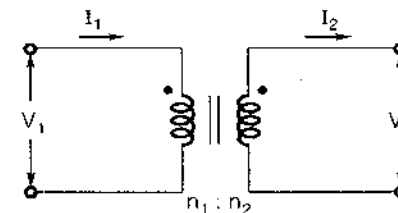

$$\frac{V_2}{V_1} = \frac{n_2}{n_1} = \frac{I_1}{I_2}$$

If $n_1 < n_2$, step up transformer
 and $n_1 > n_2$, step down transformer

Gyrator

Gyrator shows an impedance inversion.

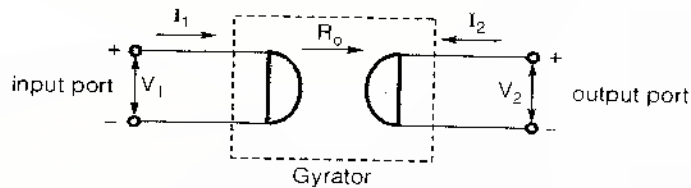

$$\begin{aligned} V_1 &= +R_o I_2 \\ V_2 &= -R_o I_1 \end{aligned}$$

where, R_o = Coefficient of gyrator and it depends upon

- (i) Op-amp parameter
- (ii) Externally connected R and C values

Remember:

- Linear network is one which holds the principle of superposition and principle of homogeneity both.
- Element conducts in both directions is called bilateral element.
- A network containing circuit elements without any energy source is called passive network.
- A network containing energy source together with other circuit elements is called active network.

Ideal Sources

1. Ideal Voltage Source

Voltage always remains constant for any value of current passing through it.

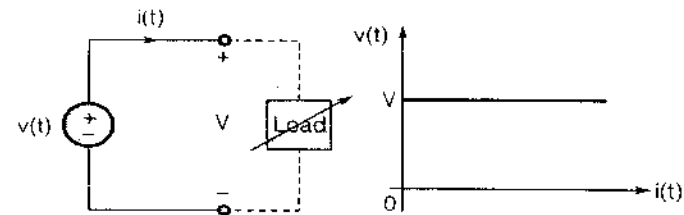

Note:

- The current through any voltage source is purely arbitrary. It will depend upon
 - (a) The current source which is connected in series with it.
 - (b) The load resistance which is connected in parallel with it.
- We cannot write KCL equation at a load with which any voltage source is connected. Since, the current through this voltage source is purely arbitrary.

2. Ideal current source

- Current always remains constant for any value of voltage across it

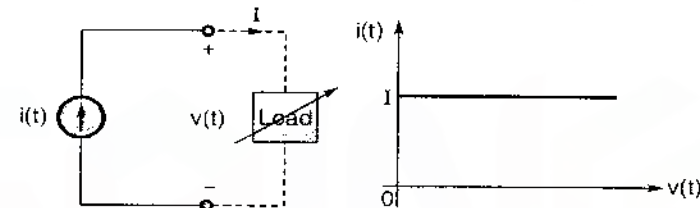

Note:

- The voltage across current source is purely arbitrary. It will depend upon
 - (a) Voltage source which is connected in parallel with it.
 - (b) The load resistance which is connected in series with it.
- We cannot write any KVL equation in a loop in which a current source is present. Since, the voltage across the current source is purely arbitrary.

Dependent Sources

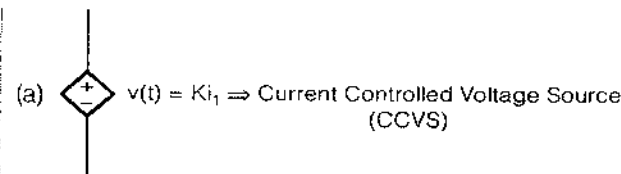

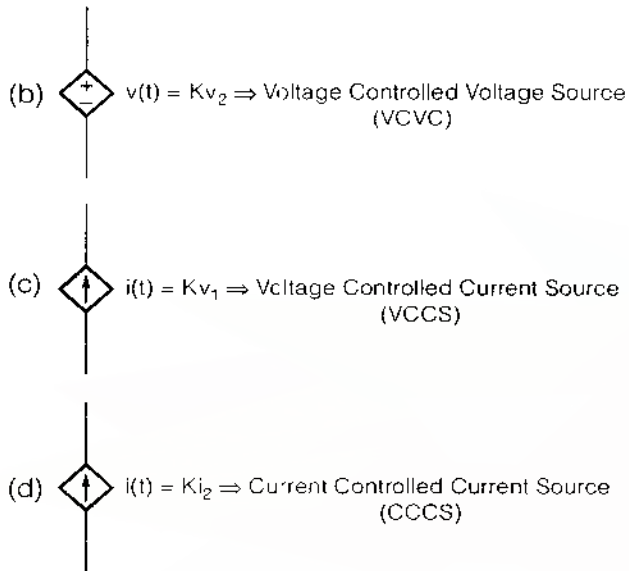

where, K is a constant.

Standard Input Signals

1. Step function

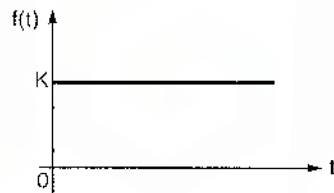

$$f(t) = \begin{cases} 0 & ; t \leq 0 \\ K & ; t > 0 \end{cases}$$

2. Gate Function

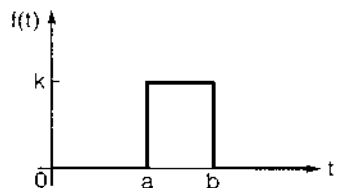

$$f(t) = K[u(t-a) - u(t-b)]$$

3. Ramp function

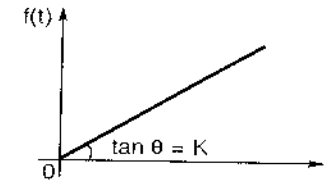

$$f(t) = \begin{cases} 0 & ; t \leq 0 \\ Kt & ; t > 0 \end{cases}$$

4. Impulse function

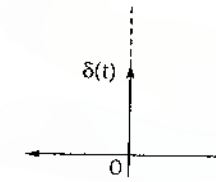

$$\delta(t) = \begin{cases} 0 & ; t \neq 0 \\ \infty & ; t = 0 \end{cases}$$

- Area under the impulse function is always unity.

$$\int_{-\infty}^{\infty} \delta(t) dt = 1$$

- Sampling property of impulse function

$$\int_{-\infty}^{\infty} f(t) \cdot \delta(t - t_0) dt = f(t_0)$$

Miscellaneous

- Average value

$$Y_{av} = \frac{1}{T} \int_0^T y(t) dt$$

where T is the time period of periodic function $y(t)$

□ RMS or effective value

$$Y_{rms} = \sqrt{\frac{1}{T} \int_0^T [y(t)]^2 dt}$$

- If $y(t) = a_0 + (a_1 \cos \omega t + a_2 \cos 2\omega t + \dots) + (b_1 \sin \omega t + b_2 \sin 2\omega t + \dots)$

$$Y_{rms} = \sqrt{a_0^2 + \frac{1}{2}(a_1^2 + a_2^2 + \dots) + \frac{1}{2}(b_1^2 + b_2^2 + \dots)}$$

□ Form factor

$$FF = \frac{Y_{rms}}{Y_{av}} = \frac{\sqrt{\frac{1}{T} \int_0^T [y(t)]^2 dt}}{\frac{1}{T} \int_0^T y(t) dt}$$

Remember:

- RMS value of $\sin \omega t$ and $\cos \omega t$ is $\frac{1}{\sqrt{2}}$.

$$\sin \omega t = \frac{e^{j\omega t} - e^{-j\omega t}}{2j} \quad \text{and} \quad \cos \omega t = \frac{e^{j\omega t} + e^{-j\omega t}}{2}$$

$$\sinh \omega t = \frac{e^{\omega t} - e^{-\omega t}}{2} \quad \text{and} \quad \cosh \omega t = \frac{e^{\omega t} + e^{-\omega t}}{2}$$

Representation of Shifted Unit Step Function

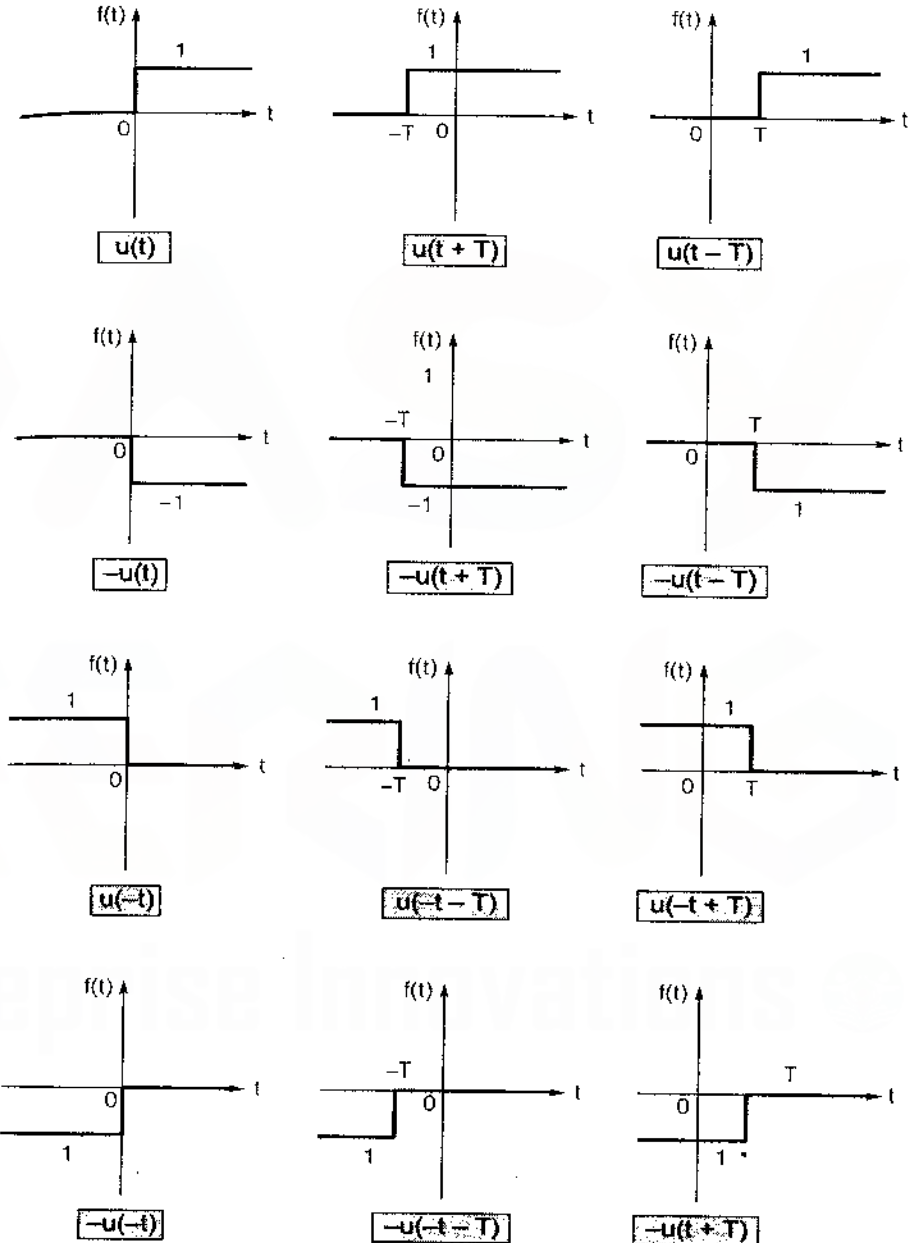

Network Laws and Theorems

2

Ohm's Law

The ratio of potential difference (V) between any two points on a conductor to the current (I) flowing through it is constant, provided the temperature of the conductor does not change.

$$\frac{V}{I} = \text{constant} \quad \text{or} \quad \frac{V}{I} = R$$

Where, R is the resistance of the conductor between the two points considered.

Kirchoff's Laws

1. Kirchoff's Voltage Law (KVL)

For any closed path in a network, the algebraic sum of the voltages is zero.

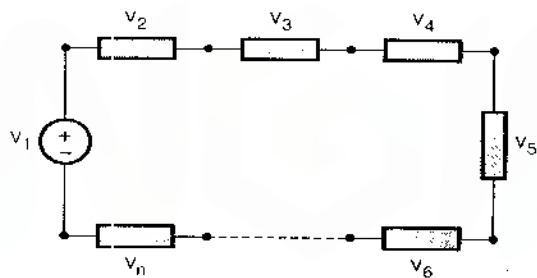

$$\sum_{k=1}^n v_k(t) = 0 \quad \dots \text{in a closed loop}$$

where, \$v_k\$ is the voltage drop or voltage gain across \$k^{th}\$ element

2. Kirchoff's Current Law (KCL)

The algebraic sum of the currents at a node is zero. Alternatively the sum of the currents entering a node is equal to the sum of the currents leaving that node.

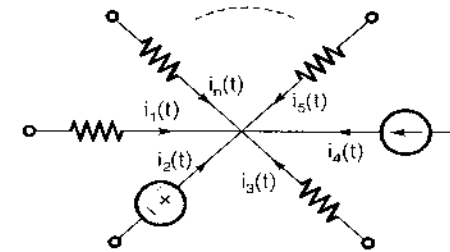

$$\sum_{k=1}^n i_k(t) = 0 \quad \dots \text{at any node}$$

where \$i_k(t)\$ is the current through \$k^{th}\$ branch

Note:

- A network is an interconnection of elements or devices, whereas a circuit is a network providing one or more closed paths.
 - Number of KVL equations = \$b - (n - 1)\$
 - Number of KCL equations = \$(n - 1)\$
- where, \$b\$ is number of branches and \$n\$ is number of nodes.
- At node, current changes and in branch, current remains same.

Voltage Division Equations

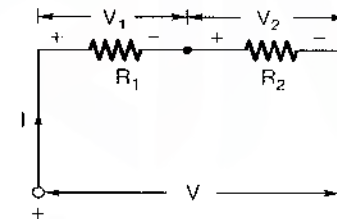

$$V_1 = \frac{R_1}{R_1 + R_2} V \quad ; \quad V_2 = \frac{R_2}{R_1 + R_2} V$$

Current Division Equations

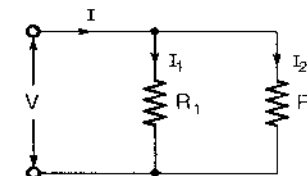

$$I_1 = \frac{R_2 I}{R_1 + R_2} \quad ; \quad I_2 = \frac{R_1 I}{R_1 + R_2}$$

Star to Delta Transformation

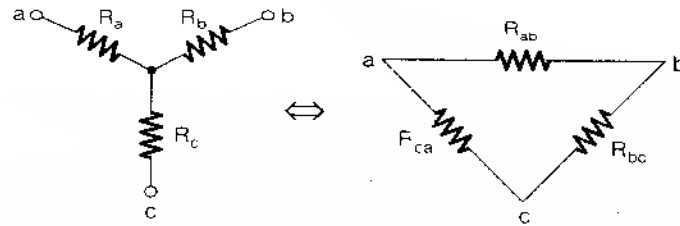

$$R_{ab} = \frac{\Delta}{R_c}, R_{bc} = \frac{\Delta}{R_a}, R_{ca} = \frac{\Delta}{R_b}$$

where, $\Delta = (R_a R_b + R_b R_c + R_c R_a)$

Delta to Star Transformation

$$R_a = \frac{R_{ca} R_{ab}}{R_{ab} + R_{bc} + R_{ca}}$$

$$R_b = \frac{R_{ab} R_{bc}}{R_{ab} + R_{bc} + R_{ca}}$$

$$R_c = \frac{R_{bc} R_{ca}}{R_{ab} + R_{bc} + R_{ca}}$$

Source Transformation

Transformation of a resistive voltage source to a resistive current source or vice-versa.

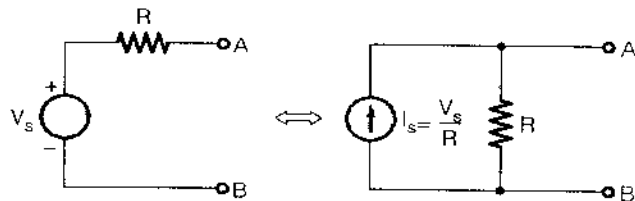

Network Theorems

1. Super Position Theorem

The response in any element of a linear, bilateral RLC network containing more than one independent voltage or current source is the algebraic sum of responses produce by the independent source when each of them acting alone with

- (a) All other independent voltage sources are short circuited (S.C.).
- (b) All other independent current sources are open circuited (O.C.).
- (c) All dependent voltage and current sources remain as they are and therefore, they are neither S.C. nor O.C.

Note:

- The theorem is not applicable to the network containing
 - (a) Non linear elements.
 - (b) Unilateral elements such as diode or BJT.
- The theorem is not applicable to power since it is a non linear parameter.
- The theorem is also applicable for circuit having initial condition.

2. Thevenin's Theorem

A linear active RLC network which contains one or more independent or dependent voltage or current sources can be replaced by a single voltage source \$V_{OC}\$ in series with equivalent impedance \$Z_{eq}\$.

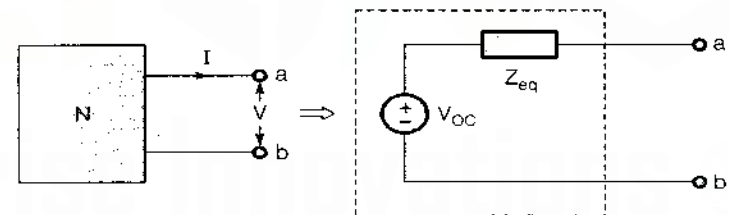

where, V_{OC} = Open circuit voltage between a and b (when $I = 0$).

Z_{eq} = Equivalent impedance between a and b, when

- (a) All independent sources are replaced by their internal impedances.
- (b) All dependent voltage and current sources are remain as they are.

Note:

Theorem is not applicable to the network containing:

- Non linear element.
- Unilateral element.

3. Norton's Theorem

A linear, active RLC network which contains one or more independent or dependent voltage or current sources can be replaced by a single current source I_{SC} in shunt with equivalent impedance Z_{eq} .

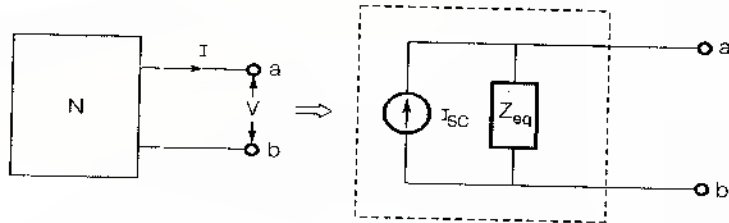

where, I_{SC} = Short circuit current between a and b (when $V = 0$)
 Z_{eq} = Same as that of Thevenin's theorem

4. Maximum Power Transfer Theorem

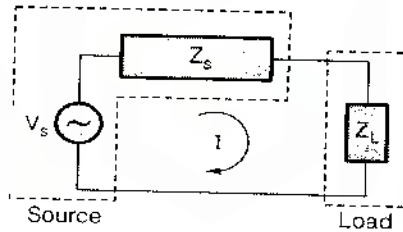

$Z_L = Z_s^*$ for maximum power transfer

Case 1: If $Z_s = R_s + jX_s$ and $Z_L = R_L + jX_L$

then $R_L = R_s$ and $X_L = -X_s$

Case 2: If $Z_s = R_s + jX_s$ and $Z_L = R_L$

then $R_L = \sqrt{R_s^2 + X_s^2}$

Case 3: If $Z_L = R_L$ and $Z_s = R_s$

then $R_L = R_s$

5. Tellegen's Theorem

- In any network, the sum of instantaneous power consumed by various elements of the branches is always equal to zero.
- Total power given out by different voltage sources is equal to total power consumed by various passive elements in various branches of the network.

$$\sum_{k=1}^b v_k \cdot i_k = 0$$

where, b = Number of branches

Note:

The theorem is valid for any type of network so long as KVL and KCL equations are valid.

6. Millman's Theorem

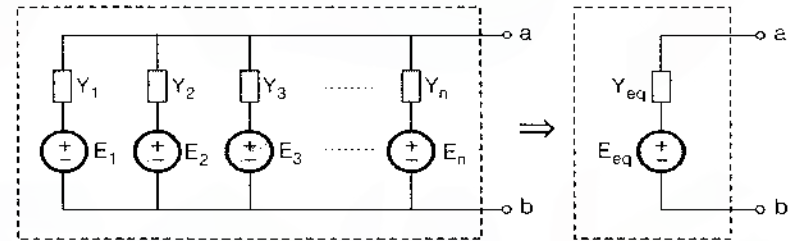

$$E_{eq} = \frac{\sum_{i=1}^n E_i Y_i}{\sum_{i=1}^n Y_i}$$

$$Y_{eq} = \sum_{i=1}^n Y_i$$

7. Reciprocity Theorem

In a linear bilateral single source network, the ratio of excitation to the response is constant when the position of excitation and response are interchange.

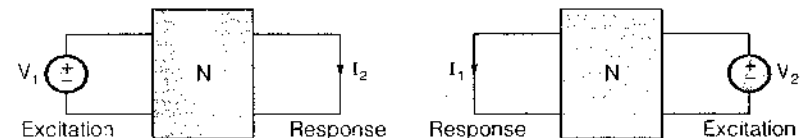

$$\frac{V_1}{I_2} = \frac{V_2}{I_1} ; Z_{12} = Z_{21}$$

Note:

$$\begin{matrix} z_{12} = z_{21} \\ z_{13} = z_{31} \\ z_{23} = z_{32} \end{matrix}$$

- ... for reciprocal network.
- The basis of the theorem is the symmetry of impedance or admittance of matrix.
- The theorem is valid for network in which linear and bilateral elements are present.
- The theorem is valid only when single independent voltage or current source is present.
- The initial conditions are assumed to be zero in reciprocity theorem.

8. Compensation Theorem

If impedance 'z' of any branch of a network is changed by ' δz ', then the incremental current ' δI ' in such branch is that which will be produced by a compensating voltage source $V_c = I \delta z$ introduced in the same branch with polarity opposing the original direction of current I.

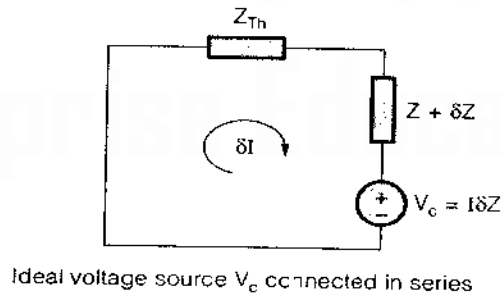
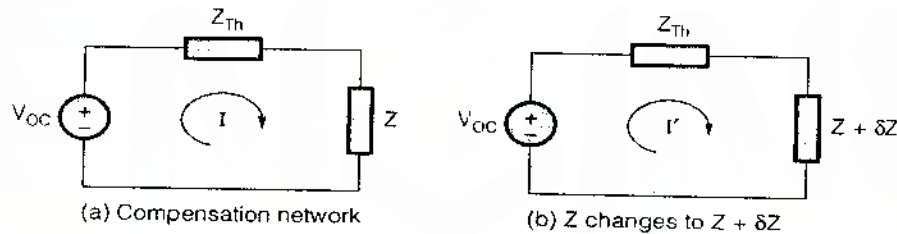

Graph Theory

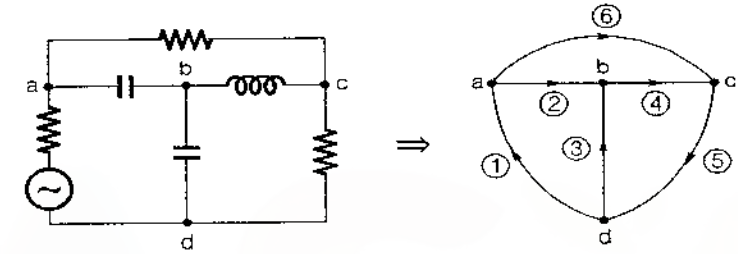

Circuit diagram of linear graph

Oriented graph

For the graph shown in the above figure

Node or vertices : {a b c d}

Branch or edge: [1, 2, 3, 4, 5, 6]

1. In fully connected graph, each node is connected to all other nodes of the graph.
2. A closed loop or a closed circuit may not contain all the nodes of the graph.
3. Degree of any node represents the number of branches which are connected to it.
4. For a fully connected graph, the degree of each node is equal to the rank of the graph.
5. Tree of the graph
 - (a) It contain all the nodes of the graph.
 - (b) If graph contains N nodes, its tree will contain n-1 branches.
 - (c) There is no closed path and hence, a tree is circuitless.
 - (d) The tree of a graph is not unique.
6. The branches of the **tree** are represented by the tree branches or the **twigs**, whereas the branches of the **co-tree** are represented by **link** or the **chords**.

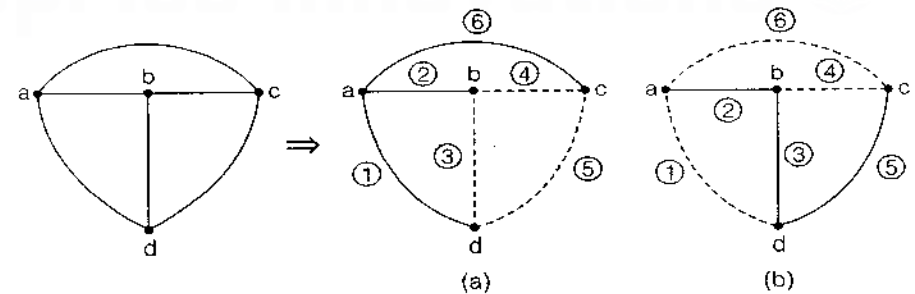

For figure (a)

Tree: [1, 2, 6]
twig

Co-tree [3, 4, 5]
link or chords

For figure (b)

Tree: [2, 3, 5]
twig

Co-tree [1, 4, 7]
link or chords

7. (a) Number of trees =

(i) $n^{(n-2)}$ (for fully connected graph)

(ii) $\det \{[A][A]^t\}$ (general expression)

where, n = Number of nodes

A = Reduced incident matrix (RIM)

$[A]^t$ = Transpose of RIM

\det = Determinant

(b) Number of branches in a fully connected graph = $\frac{n(n-2)}{2}$

(c) Number of tree branches

$$= n - 1$$

= Number of KCL equations

= Degree of each node of fully connected graph

= Rank of graph

= Number of fundamental cut-sets.

(d) Number of link/chords

$$= b - (n - 1)$$

= Number of KVL equations

= Number of tie-sets

8. A tree can be used to solve the electrical network using:

(a) tie-set schedule

(b) cut-set schedule

Matrixes

1. Incidence Matrix

(i) This matrix translates all the geometrical feature of the graph into an algebraic expression.

(ii) Every graph has incidence matrix and vice-versa.

(iii) Each row of matrix contains +1, -1, 0 depending upon the orientation of the branches with the node.

$\begin{array}{c} \bullet \\ \longrightarrow \end{array} = +1$ (if branch is pointing away from node)

$\begin{array}{c} \longrightarrow \\ \bullet \end{array} = -1$ (if branch is pointing towards a node)

$\bullet = 0$ (if branch is not connected to the node)

(iv) Each column of matrix contain only one entry of +1 and only one entry of -1 so that the sum of the element of each column is always equal to zero.

(v) The determinant of the incident matrix of a closed loop is equal to zero.

(vi) Order of matrix is $[n \times b]$

where n = node and b = branch.

(vii) Two graphs having same incidence matrix are called isomorphic graph.

Reduced incidence matrix

(i) A particular node is taken as a reference node and the row corresponding to that node is deleted, resulting in the reduced incidence matrix.

(ii) The order of matrix is $[(n-1) \times b]$.

(iii) This matrix can be utilised to find number of trees in a graph whether that graph is fully connected or not.

2. Cut set Matrix

It is a group of branches containing only one twig and a number of links.

Fundamental cut set matrix

(i) Fundamental cut set is a group of branch containing only one twig and the minimum number of links.

(ii) Fundamental cut set matrix can be used to write KCL equations for the given network.

Entry in the matrix

+1 \Rightarrow If orientation of branch is same as the orientation of cut sets related to it

-1 \Rightarrow If orientation of branch is opposite to orientation of cut set related to it

0 \Rightarrow If a cut set is not related to the branch.

Remember:

- Number of fundamental cut sets of a graph
 - = Number of twigs
 - = Number of KCL equations
 - = $(n - 1)$
 - = Number of node pair voltage
- Number of rows of the matrix = Number of fundamental cut sets
- Number of columns = Number of branches.
- Number of KCL equation = Number of fundamental cut set.

3. Tie set Matrix

It is a group of branches containing only one link and a number of twigs

Fundamental tie set matrix

- (i) It is a mathematical representation of fundamental tie sets of a graph in form of matrix.
- (ii) Fundamental Tie set is a group of branches containing only one link and minimum number of twigs.

Entry in the matrix

- +1 \Rightarrow If orientation of the branch is same as the orientation of loop current.
- 1 \Rightarrow If orientation of branch is opposite to the orientation of the loop current.
- 0 \Rightarrow If branch is not related to the loop.

Remember:

- Number of fundamental tie sets for a graph.
- = Number of links
 - = Number of KVL(mesh equation)
 - = $b - n + 1$



Laplace Transform Analysis and Circuit Transients

Laplace Transform

One sided Laplace transform of a function $f(t)$

$$\mathcal{L}\{f(t)\} = \int_0^{\infty} f(t)e^{-st} dt = F(s)$$

Note:

For the two sided Laplace transformation, the limits on the integration are from $-\infty$ to ∞ .

Properties of Laplace Transform**1. Linearity**

$$\mathcal{L}\{af_1(t) + bf_2(t)\} = aF_1(s) + bF_2(s)$$

2. Differentiation

$$\mathcal{L}\left\{\frac{d^n f(t)}{dt^n}\right\} = s^n F(s) - s^{n-1} f(0) - s^{n-2} f'(0) - s^{n-3} f''(0) - \dots$$

3. Integration

$$\mathcal{L}\left\{\int_0^t f(t) dt\right\} = \frac{F(s)}{s} + \frac{1}{s} \int_0^t f(t) dt \Big|_{0^+}$$

4. Scaling

$$\mathcal{L}\{f(at)\} = \frac{1}{|a|} F\left(\frac{s}{a}\right)$$

5. Time shifting

$$\mathcal{L}\{f(t-a)\} = e^{-as} F(s)$$

6. Shifting in s-domain

$$\mathcal{L}\{e^{-at}f(t)\} = F(s + a)$$

7. Convolution

$$\mathcal{L}\{f_1(t) * f_2(t)\} = F_1(s)F_2(s)$$

8. Initial value theorem

$$\lim_{t \rightarrow 0} f(t) = \lim_{s \rightarrow \infty} s F(s)$$

9. Final value theorem

$$\lim_{t \rightarrow \infty} f(t) = \lim_{s \rightarrow 0} s F(s)$$

10. Laplace transform of periodic function

$$F(s) = \mathcal{L}[f(t)] = \frac{\mathcal{L}[f_1(t)]}{1 - e^{-sT}}$$

where, $f(t)$ = Periodic function with time period T
 $f_1(t)$ = Function over one time period

Some Laplace Transform Pairs

$f(t)$	Laplace Inverse Laplace	$F(s)$
$\delta(t)$	\rightleftharpoons	1
$u(t)$	\rightleftharpoons	$\frac{1}{s}$
$r(t) = tu(t)$	\rightleftharpoons	$\frac{1}{s^2}$
$t^n u(t)$	\rightleftharpoons	$\frac{n!}{s^{n+1}}$
$e^{-\alpha t} u(t)$	\rightleftharpoons	$\frac{1}{s + \alpha}$
$(\sin \omega t) u(t)$	\rightleftharpoons	$\frac{\omega}{s^2 + \omega^2}$
$(\cos \omega t) u(t)$	\rightleftharpoons	$\frac{s}{s^2 + \omega^2}$

$(\sinh \omega t) u(t)$	\rightleftharpoons	$\frac{\omega}{s^2 - \omega^2}$
$(\cosh \omega t) u(t)$	\rightleftharpoons	$\frac{s}{s^2 - \omega^2}$
$(e^{-\alpha t} t^n) u(t)$	\rightleftharpoons	$\frac{n!}{(s + \alpha)^{n+1}}$
$(t \sin \omega t) u(t)$	\rightleftharpoons	$\frac{2\omega s}{(s^2 + \omega^2)^2}$
$(t \cos \omega t) u(t)$	\rightleftharpoons	$\frac{s^2 - \omega^2}{(s^2 + \omega^2)^2}$
$(e^{-\alpha t} \sin \omega t) u(t)$	\rightleftharpoons	$\frac{\omega}{(s + \alpha)^2 + \omega^2}$
$(e^{-\alpha t} \cos \omega t) u(t)$	\rightleftharpoons	$\frac{s + \alpha}{(s + \alpha)^2 + \omega^2}$

Representation of Circuit Elements in s-domain

Resistor

Energy dissipating element

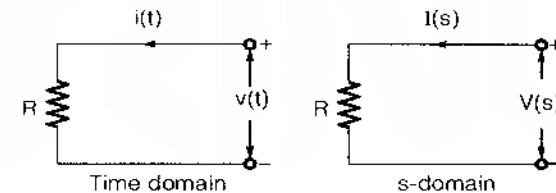

In time domain

$$V(t) = R \cdot i(t)$$

In s-domain

$$V(s) = R \cdot I(s)$$

where, $s = \sigma + j\omega$

For sinusoidal excitation

$$\sigma = 0 \text{ and } s = j\omega$$

Inductor

Energy storing element

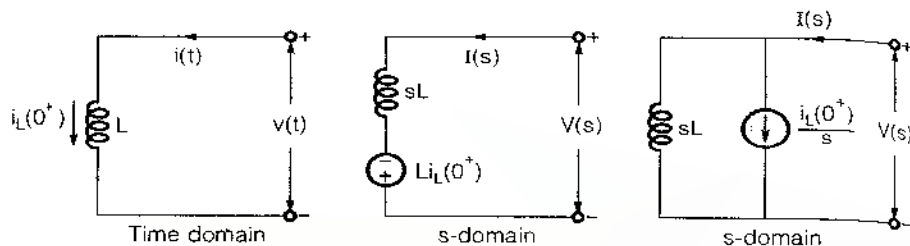

In time domain

$$v(t) = L \frac{di(t)}{dt}$$

$$i(t) = \frac{1}{L} \int_{-\infty}^t v(t) dt$$

In s-domain

$$V(s) = sL \cdot I(s) - Li_L(0^+)$$

$$I(s) = \frac{V(s)}{sL} + \frac{i_L(0^+)}{s}$$

Capacitor

Energy storing element

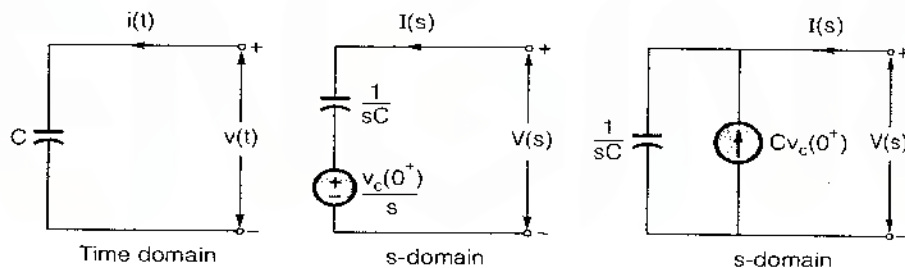

In time domain

$$i(t) = C \frac{dv(t)}{dt}$$

$$v(t) = \frac{1}{C} \int_{-\infty}^t i(t) dt$$

In s-domain

$$I(s) = sCV(s) - Cv_c(0^+)$$

$$V(s) = \frac{I(s)}{sC} + \frac{v_c(0^+)}{s}$$

Transient Response

RL Circuit

The transient current through the inductor L at any time t

$$i_L(t) = i_{\infty} - [i_{\infty} - i_{0^+}] e^{-R_{eq}t/L}$$

where, i_{∞} = Current through L as $t \rightarrow \infty$ i.e. steady-state current through L

i_{0^+} = Current through L as $t \rightarrow 0^+$

R_{eq} = Thevenin's equivalent resistance seen across L for $t > 0$.

RC Circuit

The transient voltage across capacitor C at any time t

$$v_c(t) = v_{\infty} - [v_{\infty} - v_{0^+}] e^{-t/R_{eq}C}$$

where, v_{∞} = Voltage across capacitor as $t \rightarrow \infty$ i.e. steady state voltage across C

v_{0^+} = Voltage across C as $t \rightarrow 0^+$

R_{eq} = Thevenin's equivalent resistance seen across C for $t > 0$



Resonance

Resonance

- Resonance is the condition when the voltage across a circuit becomes in phase with the current supplied to the circuit.
- At resonance, the circuit behaves like a resistive circuit.
- Power factor of the circuit at resonance is unity.

Series Resonance

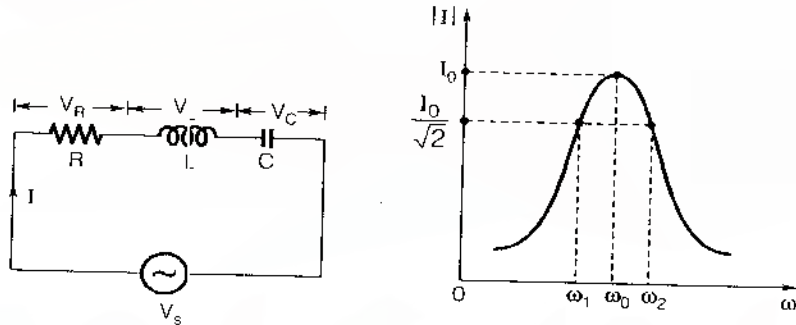

At Resonance

- $|V_L| = |V_C|$ and these are 180° out of phase
- Imaginary part of input impedance = 0

$$Z_{in} |_{\omega=\omega_0} = R \quad \dots \text{minimum}$$

$$I |_{\omega=\omega_0} = \frac{V_s}{R} \quad \dots \text{maximum}$$

where, $\omega_0 = \frac{1}{\sqrt{LC}}$ = Resonant frequency in rad/sec

Remember:

- For $\omega < \omega_0$, series RLC circuit behaves like an RC circuit.
- For $\omega > \omega_0$, series RLC circuit behaves like an RL circuit.
- For $\omega = \omega_0$, series RLC circuit behaves as resistive circuit.

Bandwidth

The bandwidth of the network represent the range of the frequencies at which the current drawn by network becomes 0.707 of its maximum value.

$$\Delta\omega = (\omega_2 - \omega_1) = \frac{R}{L}$$

$$\omega_1 = \omega_0 - \frac{1}{2}\Delta\omega \quad \text{and} \quad \omega_2 = \omega_0 + \frac{1}{2}\Delta\omega$$

$$\omega_0 = \sqrt{\omega_1 \cdot \omega_2}$$

where, ω_1, ω_2 = Cut-off frequency or half power frequency

Q-factor

The quality factor of the network is a measure of sharpness of the curve for the current drawn by circuit.

$$Q\text{-factor} = 2\pi \left(\frac{\text{Maximum energy stored}}{\text{Energy dissipated per cycle}} \right)$$

$$Q_0 = \frac{\omega_0}{\Delta\omega} = \frac{1}{\omega_0 RC} = \frac{\omega_0 L}{R} = \frac{1}{R} \sqrt{\frac{L}{C}}$$

- Frequency at which voltage across capacitor is maximum

$$f_c = \frac{1}{2\pi} \sqrt{\frac{1}{LC} - \frac{R^2}{2L^2}}$$

- Frequency at which voltage across inductor is maximum

$$f_L = \frac{1}{2\pi} \sqrt{LC - \frac{C^2 R^2}{2}}$$

- Selectivity

$$\text{Selectivity} = \frac{\text{Resonance frequency}}{\text{Bandwidth}} = \frac{f_0}{f_2 - f_1}$$

Feature of Series Resonance Circuit

- The resonant frequency is a geometric mean of the two half power frequency.

- The resonant frequency represent the rate at which the electrical energy stored in the capacitor is transformed to the magnetic energy stored in the inductor and vice versa.
- The quality factor represents the voltage amplification factor and must have high value for any tuned circuit.
- The quality factor of the resonant curve depends upon the numerical value of RLC components.
- For *tuned network*, the *quality factor* must be *high*, the *bandwidth* should be *small* and therefore the resistance use in the network should be small.
- Any *series RLC* network represents a *band pass filter*.

Parallel Resonance

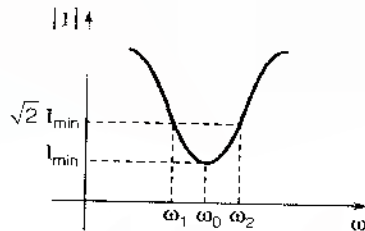
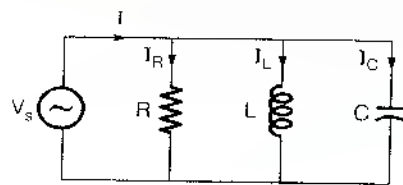

At Resonance

- $|I_L| = |I_C|$ and these are 180° out of phase
- Imaginary part of input impedance = 0

$$Z_{in}|_{\omega=\omega_0} = R \text{maximum}$$

$$I|_{\omega=\omega_0} = \frac{V_s}{R} \text{minimum}$$

where, $\omega_0 = \frac{1}{\sqrt{LC}}$ = resonant frequency in rad/sec

Remember:

- For $\omega < \omega_0$ the circuit behaves like an RL circuit.
- For $\omega > \omega_0$ the circuit behaves like an RC circuit.
- For $\omega = \omega_0$ the circuit behaves like a resistive circuit.



Bandwidth

$$\Delta\omega = (\omega_2 - \omega_1) = \frac{1}{RC}$$

Q-Factor

$$Q_0 = \frac{\omega_0}{\Delta\omega} = \omega_0 RC = \frac{R}{\omega_0 L} = R \sqrt{\frac{C}{L}}$$

Feature of Parallel RLC Circuit

- The *quality factor* of the network represents the *current amplification* factor and must have a high value for any tuned circuit.
- For a *tune network*, the *quality factor* should be *high* and therefore should have *low bandwidth* therefore the *capacitance* value is *kept high*.
- A *parallel RLC* network behaves as a *band stop filter* or *band reject filter*.

Magnetically Coupled Circuit

6

- When the two inductor are placed physically close to each other, then due to current flow in the first inductor there will be some magnetic flux, part of which will link with the second inductor. Due to rate of change of magnetic flux and by using Faraday's law of electromagnetic induction some induced voltage is produced between the two terminals of the second inductor.
- The polarity of the induced voltage depends upon the relative sense of windings of the two inductors and therefore, the induced voltage may be additive or subtractive in nature.

Cases:

(A)

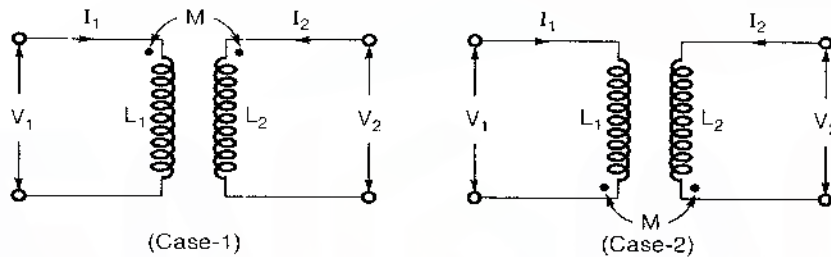

For above two cases, the effect of mutual inductance is positive. Also induced emf (e_{ind}) is additive in nature:

KVL in time domain:

$$V_1 = L_1 \frac{dI_1}{dt} + M \frac{dI_2}{dt}$$

$$V_2 = M \frac{dI_1}{dt} + L_2 \frac{dI_2}{dt}$$

KVL in s-Domain:

$$V_1(s) = L_1 s I_1(s) + M s I_2(s)$$

$$V_2(s) = M s I_1(s) + L_2 s I_2(s)$$

$$\begin{bmatrix} V_1(s) \\ V_2(s) \end{bmatrix} = \begin{bmatrix} sL_1 & sM \\ sM & sL_2 \end{bmatrix} \begin{bmatrix} I_1(s) \\ I_2(s) \end{bmatrix}$$

For sinusoidal excitation:

$$\begin{bmatrix} V_1 \\ V_2 \end{bmatrix} = \begin{bmatrix} j\omega L_1 & j\omega M \\ j\omega M & j\omega L_2 \end{bmatrix} \begin{bmatrix} I_1 \\ I_2 \end{bmatrix}$$

(B)

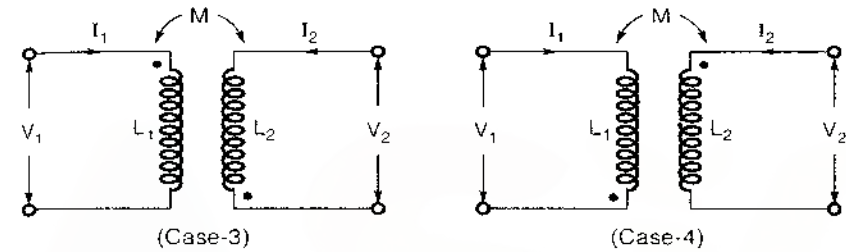

For above two cases, effect of the mutual coupling is negative. So e_{ind} is subtractive in nature.

KVL in time domain:

$$V_1 = L_1 \frac{dI_1}{dt} - M \frac{dI_2}{dt}$$

$$V_2 = -M \frac{dI_1}{dt} + L_2 \frac{dI_2}{dt}$$

KVL in s-domain:

$$\begin{bmatrix} V_1(s) \\ V_2(s) \end{bmatrix} = \begin{bmatrix} sL_1 & -sM \\ -sM & sL_2 \end{bmatrix} \begin{bmatrix} I_1(s) \\ I_2(s) \end{bmatrix}$$

For sinusoidal excitation:

$$\begin{bmatrix} V_1 \\ V_2 \end{bmatrix} = \begin{bmatrix} j\omega L_1 & -j\omega M \\ -j\omega M & j\omega L_2 \end{bmatrix} \begin{bmatrix} I_1 \\ I_2 \end{bmatrix}$$

Representation of Mutual Inductance

Case-1: In terms of M.

Case-2: In terms of 'K' i.e. coefficient of coupling.

$$K = \frac{M}{\sqrt{L_1 L_2}}$$

- (a) If $K < 1$; loose coupling (under coupling circuit).
 (b) If $K = 1$ i.e. $M = \sqrt{L_1 L_2}$; (critical coupling)
 (c) $K > 1$; tight coupling (over coupled circuit).

Case-3: In terms of turns ratio

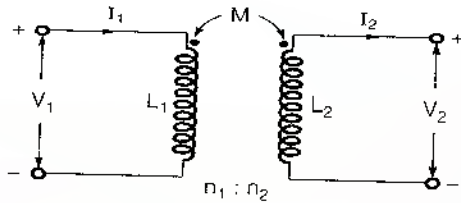

$$\frac{V_1}{V_2} = \frac{n_1}{n_2} = \frac{I_2}{I_1}$$

and

$$\frac{n_1}{n_2} \cong \frac{L_1}{M} \cong \frac{M}{L_2} = \sqrt{\frac{L_1}{L_2}}$$

■ ■ ■ ■



Two Port Network

Two Port Network

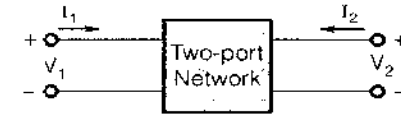

Driving Point Impedance and Admittance Functions

- Driving point impedance function

$$Z_{11}(s) = \frac{V_1(s)}{I_1(s)} \quad \text{and} \quad Z_{22}(s) = \frac{V_2(s)}{I_2(s)}$$

- Driving point admittance function

$$Y_{11}(s) = \frac{I_1(s)}{V_1(s)} \quad \text{and} \quad Y_{22}(s) = \frac{I_2(s)}{V_2(s)}$$

Impedance and Admittance Transfer Function

- Impedance Transfer Function

$$Z_{21}(s) = \frac{V_2(s)}{I_1(s)} \quad \text{and} \quad Z_{12}(s) = \frac{V_1(s)}{I_2(s)}$$

- Admittance Transfer Function

$$Y_{21}(s) = \frac{I_2(s)}{V_1(s)} \quad \text{and} \quad Y_{12}(s) = \frac{I_1(s)}{V_2(s)}$$

Voltage and Current Transfer Function

- Voltage transfer function

$$G_{12}(s) = \frac{V_1(s)}{V_2(s)} \quad \text{and} \quad G_{21}(s) = \frac{V_2(s)}{V_1(s)}$$

- Current transfer function

$$\alpha_{12} = \frac{I_1(s)}{I_2(s)} \text{ and } \alpha_{21} = \frac{I_2(s)}{I_1(s)}$$

Parameters

Impedance or z-parameters (Open circuit parameters)

$$V_1 = z_{11}I_1 + z_{12}I_2$$

$$V_2 = z_{21}I_1 + z_{22}I_2$$

Admittance or y-parameters (Short circuit parameters)

$$I_1 = y_{11}V_1 + y_{12}V_2$$

$$I_2 = y_{21}V_1 + y_{22}V_2$$

h-parameters (Hybrid parameters)

$$V_1 = h_{11}I_1 + h_{12}V_2$$

$$I_2 = h_{21}I_1 + h_{22}V_2$$

g-parameters (Inverse hybrid parameters)

$$I_1 = g_{11}V_1 + g_{12}I_2$$

$$V_2 = g_{21}V_1 + g_{22}I_2$$

ABCD parameters (Transmission parameters)

$$V_1 = AV_2 - BI_2$$

$$I_1 = CV_2 - DI_2$$

Conditions for a network to be symmetrical and reciprocal

Reciprocal	Symmetrical
$z_{12} = z_{21}$	$z_{11} = z_{22}$
$y_{12} = y_{21}$	$y_{11} = y_{22}$
$\begin{vmatrix} A & B \\ C & D \end{vmatrix} = 1$	$A = D$
$h_{12} = -h_{21}$	$\begin{vmatrix} h_{11} & h_{12} \\ h_{21} & h_{22} \end{vmatrix} = 1$
$g_{12} = -g_{21}$	$\begin{vmatrix} g_{11} & g_{12} \\ g_{21} & g_{22} \end{vmatrix} = 1$

Interconnection Between two-port Network

Cascaded Network

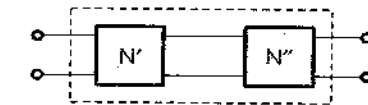

$$\begin{bmatrix} A & B \\ C & D \end{bmatrix} = \begin{bmatrix} A' & B' \\ C' & D' \end{bmatrix} \begin{bmatrix} A'' & B'' \\ C'' & D'' \end{bmatrix}$$

Series Network

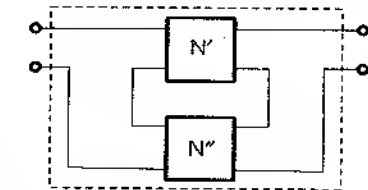

$$\begin{bmatrix} Z_{11} & Z_{12} \\ Z_{21} & Z_{22} \end{bmatrix} = \begin{bmatrix} Z'_{11} + Z''_{11} & Z'_{12} + Z''_{12} \\ Z'_{21} + Z''_{21} & Z'_{22} + Z''_{22} \end{bmatrix}$$

Parallel Network

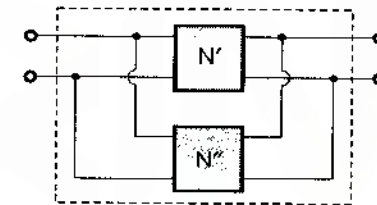

$$\begin{bmatrix} Y_{11} & Y_{12} \\ Y_{21} & Y_{22} \end{bmatrix} = \begin{bmatrix} Y'_{11} + Y''_{11} & Y'_{12} + Y''_{12} \\ Y'_{21} + Y''_{21} & Y'_{22} + Y''_{22} \end{bmatrix}$$

Series-parallel Network

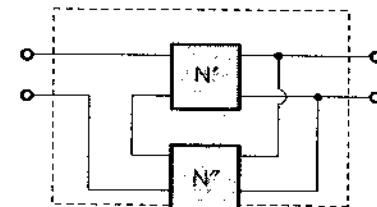

$$\begin{bmatrix} h_{11} & h_{12} \\ h_{21} & h_{22} \end{bmatrix} = \begin{bmatrix} h'_{11} + h''_{11} & h'_{12} + h''_{12} \\ h'_{21} + h''_{21} & h'_{22} + h''_{22} \end{bmatrix}$$

Parallel-series Network

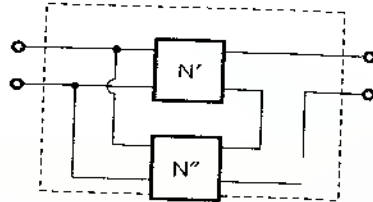

$$\begin{bmatrix} g_{11} & g_{12} \\ g_{21} & g_{22} \end{bmatrix} = \begin{bmatrix} g'_{11} + g''_{11} & g'_{12} + g''_{12} \\ g'_{21} + g''_{21} & g'_{22} + g''_{22} \end{bmatrix}$$

Lattice Network

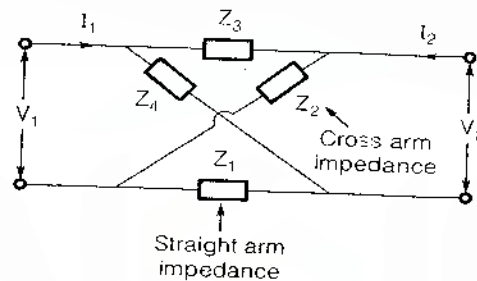

1. A lattice network is said to be symmetrical if the two straight arm impedances are equal i.e. $Z_1 = Z_3$.
Therefore, $Z_{11} = Z_{22}$
2. A lattice network is said to be reciprocal if the two cross arm impedances are equal i.e. $Z_2 = Z_4$.
Therefore, $Z_{12} = Z_{21}$



Network Synthesis

8

Before any network is synthesized, we have to check whether the given network is:

1. **Physically realisable:** For a physically realisable network, all the element values must be positive. Therefore, all the poles of the given network function must lie in the left half of the s-plane.
2. **Stable:** For a stable network, the output of the network must be finite for the finite input.

Condition for Physically Realisability & Stability of a Network

$$F(s) = \frac{\text{Numerator of polynomial}}{\text{Denominator of polynomial}}$$

(a) Network is always physically realisable when

Any network function $F(s)$ with poles in left half of s-plane has inverse Laplace transform, which is zero for $t < 0$. Therefore, such a network will be a causal network and therefore, will always be a physically realisable network.

(b) For stability of a network:

1. The network function $F(s)$ cannot have poles in the right half of the s-plane.
2. $F(s)$ cannot have multiple poles on the $j\omega$ axis.
3. The degree of numerator of the network function $F(s)$ cannot exceed the degree of denominator by more than unity.

Note:

Any stable network will always be a physically realisable network but the reverse may not be true.
.....

Feature of Hurwitz Polynomial

1. The Hurwitz polynomial represents the denominator polynomial of a stable and physically realizable network function.
2. This polynomial represents whether all the poles of the network function lie in left half of s-plane or not.

3. No term in a polynomial must be missing unless all the even parts or all the odd parts are missing.
4. No coefficient in the polynomial must be negative.
5. The continue fraction expansion (C.F.E.) of even to odd parts or odd to even parts has all positive quotient terms. These quotient terms represent the numerical value of RLC component of the network.
6. If any polynomial have only even parts or odd parts, then the given polynomial $P(s)$ is Hurwitz when the continued fraction expansion of $\frac{P(s)}{P'(s)}$ has all positive quotient term.
7. If $P(s) = P_1(s) \cdot P_2(s)$, then the polynomial $P(s)$ is Hurwitz when the polynomial $P_1(s)$ and $P_2(s)$ are individually Hurwitz.

Positive Real Function (PRF)

The positive real functions represent physically realizable and stable passive driving point immittance function.

Features of PRF

1. If $F(s)$ is positive real function, then $\frac{1}{F(s)}$ is also a PRF.
2. The sum of two PRF is also a PRF.
3. The poles and zeroes of a PRF cannot lie in right half of the s-plane.
4. Only simple poles with positive real residue can exist on $j\omega$ axis.
5. The poles and zeroes of a PRF are real or occur in complex conjugate pair.
6. The highest and lowest power of the numerator and denominator polynomial may differ at most by unity.

The Necessary and Sufficient Condition for $F(s)$ to be PRF

1. $F(s)$ must have no poles and zeros in the right half of s-plane, therefore the numerator and denominator polynomial must be Hurwitz.
2. $F(s)$ may have only simple poles on the $j\omega$ axis with positive real residues. Therefore, the partial fraction expansion is found and is verify for the residues of the poles which lie on the $j\omega$ axis.
3. $\text{Re}[F(s)]_{s=j\omega} \geq 0$, for all values of ω .

Synthesis of Different Network Function

Case-1: Synthesis of LC immittance function (Z_{LC}, Y_{LC})

Features

1. This function is a ratio of odd to even or even to odd polynomials.
2. The poles and zero are simple, lie on the $j\omega$ axis and they alternate.
3. There must be either a zero or a pole at the origin and at ∞ .
4. Highest power of numerator and denominator must differ by unity.
5. Lowest powers of numerator and denominator polynomial must also differ at most by unity.

Case-2: Synthesis of RC impedance function or RL admittance function (Z_{RC}, Y_{RL})

Features

1. All the poles and zeros lie on negative real axis and they alternate.
2. The singularity nearest to or at the origin must be a pole where as the singularity nearest to or at ∞ must be a zero.
3. The residues of the poles must be real and positive.

Case-3: Synthesis of RL impedance function or RC admittance function (Z_{RL}, Y_{RC})

Features

1. All the poles and zeroes lie on negative real axis and they alternate.
2. The singularity nearest to or at the origin must be a zero, where as the singularity nearest to or at ∞ must be a pole.
3. The residues of the poles must be real and negative.

Case-4: Driving point RLC immittance function (Z_{RLC}, Y_{RLC})

Features

No set rules are follow for the location of the poles and zeros. Therefore, the poles and zeros can lie anywhere in the left half of s-plane.

Synthesis of Network Function by Cauer's Form

1. In both Cauer's type-I and type-II forms, the elements are connected in series-parallel-series-parallel form.
2. If an impedance function is given, then the first element represents impedance and therefore represents a series element in the ladder network.
3. If an admittance function is given, the first element represents admittance and therefore, represents a parallel element.
4. In a RLC network, the number of elements is equal to sum of total number of zeros and poles.
5. In Cauer's type-I form, inductor is always a series element where as a capacitor is a shunt element.
6. In Cauer's type-II form, the capacitor is always a series element where as inductor is a shunt element.
7. In Cauer's type-I form, continued fraction expansion (CFE) is found by rearranging the numerator and denominator polynomial in the descending power of s .
8. In Cauer's type-II form, continued fraction expansion is found by rearranging numerator and denominator polynomial in ascending power of s .



Dual Network

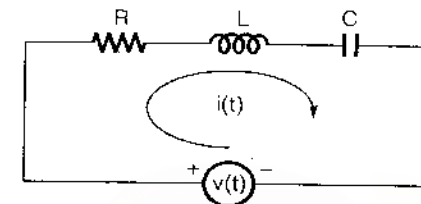

Series RLC circuit (N_1)

By applying KVL,

$$v(t) = Ri(t) + L \frac{di}{dt} + \frac{1}{C} \int_0^t i(t) dt$$

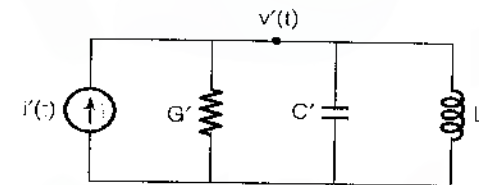

Parallel RLC circuit (N_2)

By applying KCL,

$$i'(t) = v'(t)G' + C' \frac{dv'(t)}{dt} + \frac{1}{L'} \int_0^t v'(t) dt$$

- The networks N_1 and N_2 are called dual networks but these networks are not equivalent networks and therefore, the network N_1 cannot be replaced by N_2 network.
- The KVL equation for network N_1 has similar format as for the KCL equation for network N_2 . Therefore, if the response of the first network is known in terms of current $i(t)$ then the response of its dual network for voltage $v'(t)$ can be directly written without actually solving it by using necessary transformation by various elements as follows:

N_1	N_2
$v(t)$	$i(t)$
R	G
G	R
L	C
C	L
KVL	KCL



A Handbook on Electrical Engineering

6

Control Systems

CONTENTS

1. Introduction	335
2. Mathematical Modelling	337
3. Transfer Function	347
4. Time Response Analysis of Control System	353
5. Stability in Time-Domain	363
6. Industrial Controller	368
7. Compensator	371
8. Frequency Response Analysis	374
9. State Space Analysis	384

Introduction



A control system is a combination of elements arranged in a planned manner wherein each element causes an effect to produce a desired output.

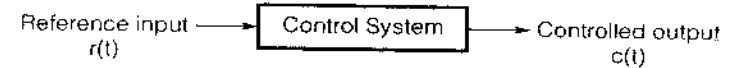

Classification of Control System

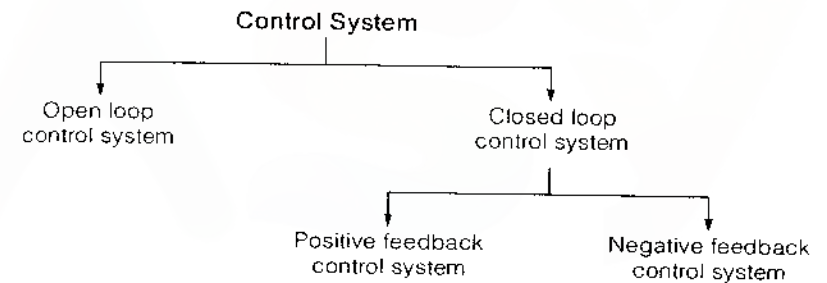

Open Loop Control System

It is a conditional control system, formulated under the basic condition that, the system is not subjected to any type of the disturbances. Control characteristics of such systems are independent of output of the system. The output is neither measured nor feedback for comparison with the input.

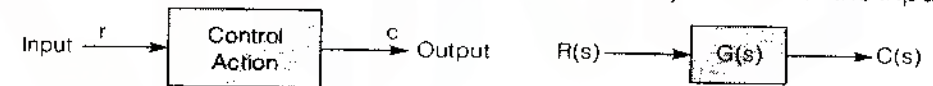

Note:

- Performance analysis is not applicable to open loop system because they are highly stable system.
- Faithfulness of an open loop control system depends upon the accuracy of input calibration.

Closed Loop Control System

Control characteristics of the system depends upon the output of the system. It is also termed as feedback control system. The control action is actuated by an error signal 'e', which is the difference between input signal and output signal. The purpose of feedback is to reduce the error between the reference input and the system output.

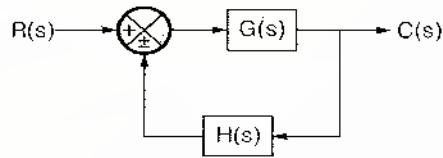
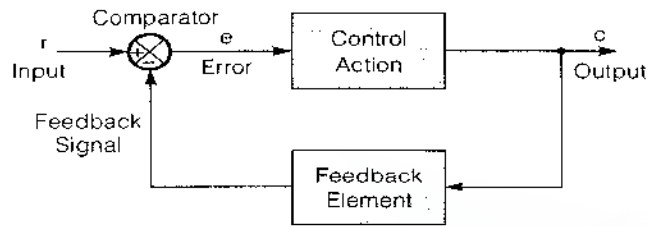

Effect of Negative Feedback

1. Effect of parameter variation reduces.
2. The gain of system reduces by a factor (1 + GH).
3. The bandwidth of the system increases.
4. Effect of internal disturbance reduces.

Note:

- Except oscillators, in positive feedback, we have always unstable systems.
- Closed loop system is complex and costly.

Comparison of Open Loop and Closed Loop Control System

Open Loop System	Close Loop System
1. So long as the calibration is good, as open-loop system will be accurate	1. Due to feedback, the close-loop system is more accurate
2. Organization is simple and easy to construct	2. Complicated and difficult
3. Generally stable in operation	3. Stability depends on system components
4. If non-linearity is present, system operation degenerates	4. Comparatively, the performance is better than open-loop system if non-linearity is present



Mathematical Modelling

Mechanical Systems

All mechanical systems are classified of two types.

- (i) Mechanical translation system.
- (ii) Mechanical rotational system.

1. Mechanical Translational System

Input : Force

Output : Linear displacement (x) OR Linear velocity (v)

(a) Inertia force

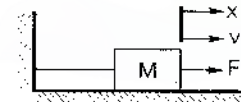

$$F = M \frac{d^2x}{dt^2} = M \frac{dv}{dt}$$

where,

F = Force on block M

x = Displacement of block M

v = Velocity of block M

M = Mass of block M

(b) Damping force

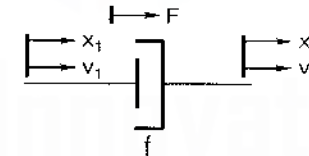

$$F = f \frac{d(x_1 - x_2)}{dt} = f(v_1 - v_2)$$

where, F = Damper force

x₁, x₂ = Displacement at side 1 and 2 of damper

v₁, v₂ = Velocity at side 1 and 2

f = Damper constant

(c) Spring force

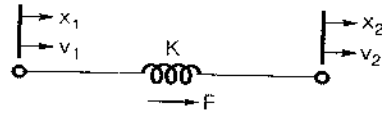

$$F = K(x_1 - x_2) = K \int (v_1 - v_2) dt$$

- where
- F = Spring force
 - x_1, x_2 = Compression or expansion of spring
 - v_1, v_2 = Velocity at side 1 and 2
 - K = Spring constant

2. Mechanical Rotational System

Input : Torque (T)
Output : Angular displacement (θ) OR Angular velocity (ω)

(a) Inertia torque

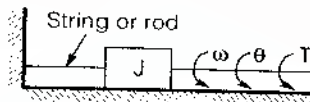

$$T = J \frac{d^2\theta}{dt^2} = J \frac{d\omega}{dt}$$

(b) Damper torque

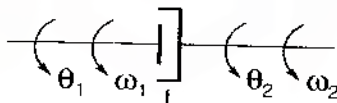

$$T = f \frac{d\theta}{dt} = f(\omega_1 - \omega_2)$$

(c) Spring torque

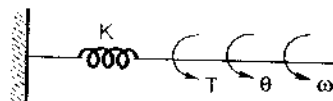

$$T = K\theta = K \int \omega dt$$

Analogous System

Electrical equivalent of mechanical system called analogous system

1. Mechanical Translation Systems

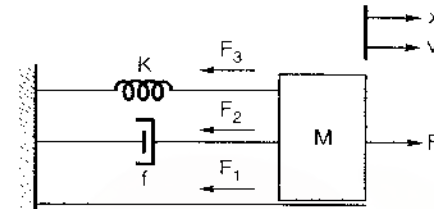

$$F = F_1 + F_2 + F_3$$

$$F = M \frac{dv}{dt} + fv + K \int v dt$$

$$F = M \frac{d^2x}{dt^2} + f \frac{dx}{dt} + Kx$$

2. Mechanical Rotational Systems

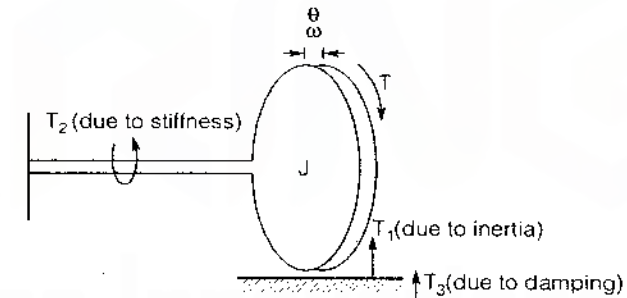

$$T = T_1 + T_2 + T_3$$

$$T = J \frac{d\omega}{dt} + f\omega + K \int \omega dt$$

$$T = J \frac{d^2\theta}{dt^2} + f \frac{d\theta}{dt} + K\theta$$

3. Electrical Series RLC Systems

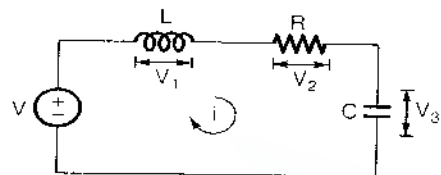

$$V = V_1 + V_2 + V_3$$

$$V = L \frac{di}{dt} + iR + \frac{1}{C} \int i dt$$

$$V = L \frac{d^2q}{dt^2} + R \frac{dq}{dt} + \frac{q}{C}$$

Electrical Parallel RLC Systems

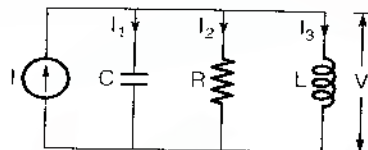

$$I = I_1 + I_2 + I_3$$

$$I = C \frac{dv}{dt} + \frac{v}{R} + \frac{1}{L} \int v dt$$

$$I = C \frac{d^2\phi}{dt^2} + \frac{1}{R} \frac{d\phi}{dt} + \frac{\phi}{L}$$

Force Voltage Analogy & Force Current Analogy

Series RLC	Parallel RLC	Mechanical Translation System	Mechanical Rotational System
V	I	F	T
q	φ	x	θ
R	1/R	f	f
I	V	Linear velocity (v)	Angular velocity (ω)
1/C	1/L	K	K
L	C	M	J

Nodal Method

1. Number of nodes = Number of displacement.
2. Take an additional node which is reference node.
3. Connect the mass or inertia element between principle node and reference node only.
4. Connect the spring and damping elements either between the principle nodes or between the principal node and reference node, depending on their position.
5. Obtain the nodal diagram and write the differential equation at each node.

Servomotors

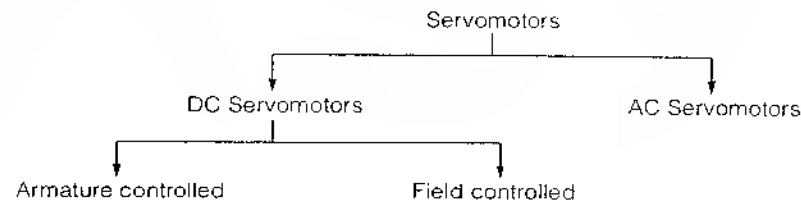

1. Armature Controlled DC Servo Motors

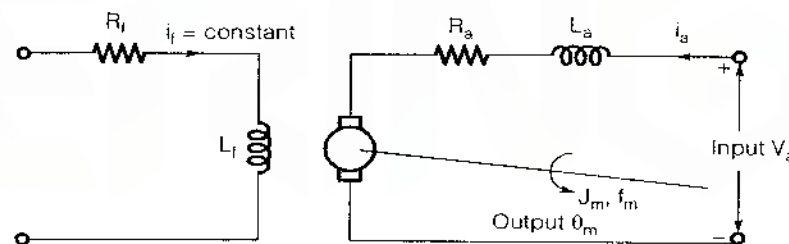

□ Block diagram

(a) Relating θm(s) and Va(s)

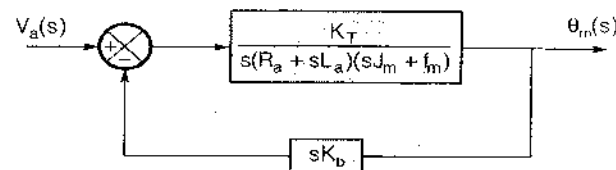

(b) Relating $\omega_m(s)$ and $V_a(s)$

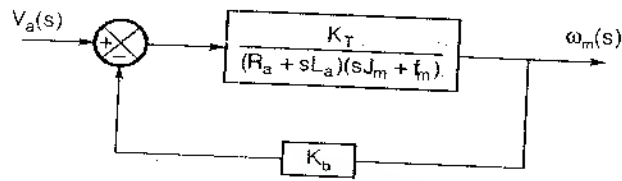

Dynamic equations

Dynamic equations in time domain	Corresponding equation in s-domain
$V_a - e_b = R_a i_a + L_a \frac{di_a}{dt}$	$V_a(s) - E_b(s) = R_a I_a(s) + sL_a I_a(s)$
$e_b = K_b \frac{d\theta_m}{dt} = K_b \omega_m$	$E_b(s) = sK_b \theta_m(s) = K_b \omega_m(s)$
$T_M = K_T i_a$	$T_M(s) = K_T I_a(s)$
$T_M = J_m \frac{d^2\theta_m}{dt^2} + f_m \frac{d\theta_m}{dt}$	$T_M(s) = s^2 J_m \theta_m(s) + s f_m \theta_m(s)$
$T_M = J_m \frac{d\omega_m}{dt} + f_m \omega_m$	$T_M(s) = s J_m \omega_m(s) + f_m \omega_m(s)$

2. Field Controlled DC Servomotor

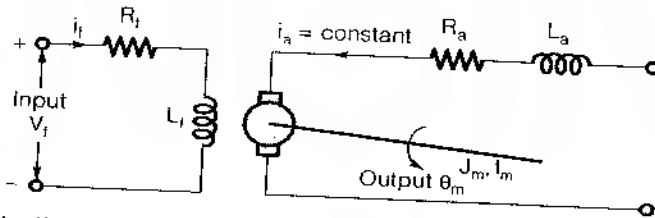

Block diagram

(a) Relating $\theta_m(s)$ and $V_f(s)$

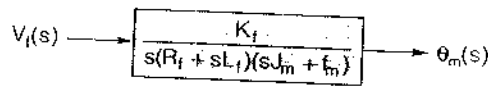

(b) Relating $\omega_m(s)$ and $V_f(s)$

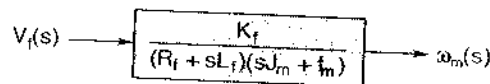

Dynamic equations

Dynamic equations in time domain	Corresponding equation in s-domain
$V_f = R_f i_f + L_f \frac{di_f}{dt}$	$V_f(s) = R_f I_f(s) + sL_f I_f(s)$
$T_M = K_f i_f$	$T_M(s) = K_f I_f(s)$
$T_M = J_m \frac{d^2\theta_m}{dt^2} + f_m \frac{d\theta_m}{dt}$	$T_M(s) = s^2 J_m \theta_m(s) + s f_m \theta_m(s)$
$T_M = J_m \frac{d\omega_m}{dt} + f_m \omega_m$	$T_M(s) = s J_m \omega_m(s) + f_m \omega_m(s)$

3. Two Phase AC Servomotor

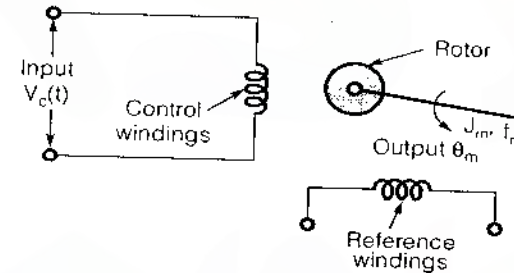

Block diagram

(a) Relating $\theta_m(s)$ and $V_c(s)$.

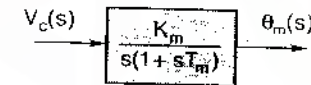

(b) Relating $\omega_m(s)$ and $V_c(s)$.

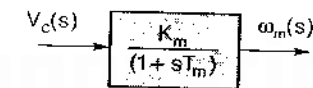

Dynamic equations

Dynamic equations in time domain	Corresponding equations in s-domain
$T_M = m \frac{d\theta_m}{dt} + KV_c$	$T_M(s) = sm\theta_m(s) + KV_c(s)$
$T_M = J_m \frac{d^2\theta_m}{dt^2} + f_m \frac{d\theta_m}{dt}$	$T_M(s) = s^2 J_m \theta_m(s) + s f_m \theta_m(s)$

where, $m = \frac{T_o}{\omega_o}$ (slope of torque speed characteristic)

$$K = \frac{T_o}{V_c}$$

T_o = Stalling torque

ω_o = No load speed

Generators

1. Separately Excited DC Generator

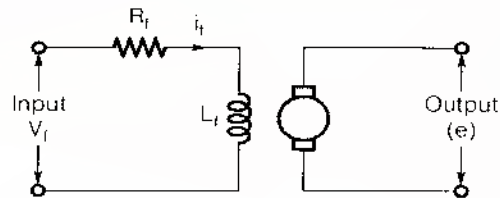

Block diagram

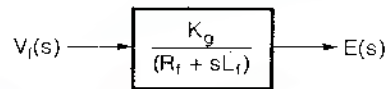

Dynamic equations

Related equations in time domain	Corresponding equations in s-domain
$V_f = R_f i_f + L_f \frac{di_f}{dt}$	$V_f(s) = R_f i_f(s) + sL_f i_f(s)$
$e = K_g i_f$	$E(s) = K_g i_f(s)$

where, K_g = Generator constant

2. Separately Excited DC Generator Connected to Load

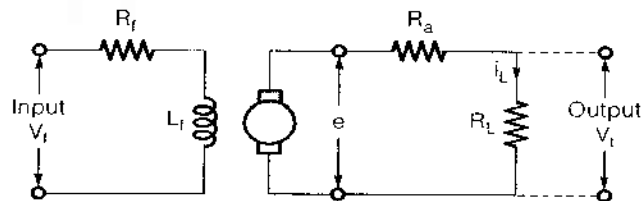

Block diagram

Relating $V_t(s)$ and $V_f(s)$

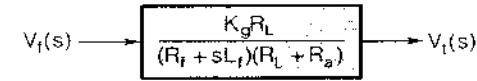

Dynamic equations

Related equations in time domain	Corresponding equations in s-domain
$V_t = e - R_a i_L$	$V_t(s) = E(s) - R_a i_L(s)$
$i_L = \frac{V_t}{R_L}$	$i_L(s) = \frac{V_t(s)}{R_L}$

Note:

- Servomechanism is electromechanical system whose input is electrical **voltage** and output is mechanical **position** or its time derivative.
- Field control DC servo motor is used for low power applications while armature control DC servomotor is used for high power applications.
- AC servomotor is generally used for low power application.
- Torque speed characteristic is linear for AC servomotor whereas, it is nonlinear for general purpose induction motor.
- For the fast response of the servomotor system, the inertia of the rotor should be kept to minimum. This is achieved by reducing the diameter and increasing the length of the rotor.

Tachometer

Tachometer is speed transducer, used as feedback element in control system.

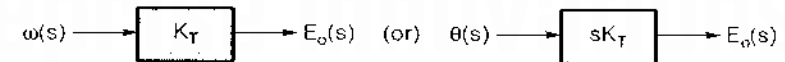

where, sK_T = Tachometer constant

Potentiometer

It is variable resistive displacement transducer. A pair of potentiometer act as error detectors in control system application.

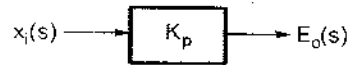

Input = Wiper displacement (x_i)

Output = Voltage (e_o)

$$K_p = \frac{e_i}{x_t} = \text{Potentiometer gain}$$

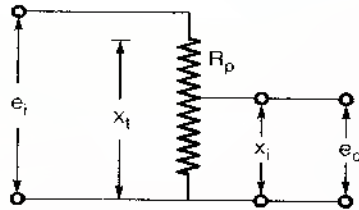

Transfer Function

3

Transfer function

The transfer function of a linear, time-invariant, differential equation system is defined as the ratio of the Laplace transform of the output to the Laplace transform of the input, under the assumption that all initial conditions are zero.

Note:

- A system is said to be linear if principle of superposition and principle of homogeneity applies.
- A differential equation is linear if the coefficients are constants or function only of independent variable.

Open Loop Transfer Function

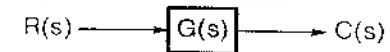

□ Transfer function (T.F.)

$$\text{T.F.} = \frac{C(s)}{R(s)} = G(s)$$

where, $C(s)$ = Laplace transform of output

$R(s)$ = Laplace transform of input

□ Impulse response of a system

$$g(t) = c(t)$$

where, $g(t)$ = Impulse response

$c(t)$ = Output to the system

Note:

The transfer function of a system is the Laplace transform of its impulse response.

Closed Loop Transfer Function

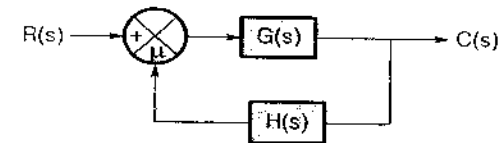

Transfer function

$$T.F. = \frac{G(s)}{1 \pm G(s)H(s)}$$

Block Diagram Reduction

Equivalent Block Diagram	Original Block Diagram

Rules for Drawing Signal Flow Graph From A Given Block Diagram

While drawing SFG from a given block diagram, the adjacent summing points and take-off points (but not a take-off point preceding a summing point in the direction of SFG) are represented by a node and the block transfer function is represented by a line joining the respective nodes. The direction of signal flow is indicated by an arrow on the line.

2. If in the direction of signal flow, a take-off point precedes a summing point then such points are represented by two separate nodes with a transmittance of unity between them.

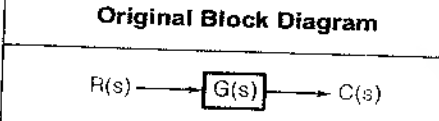
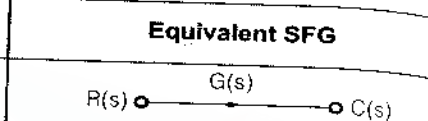
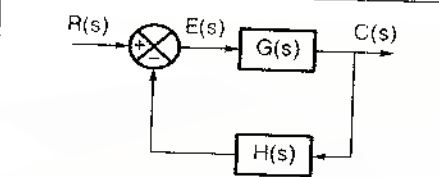
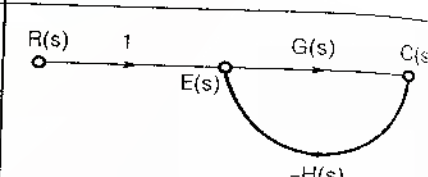
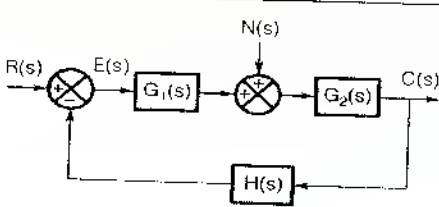
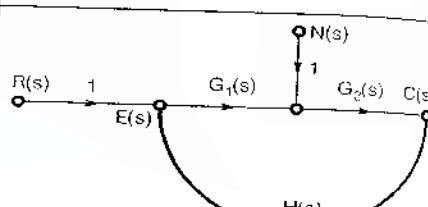
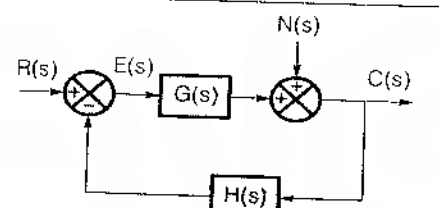
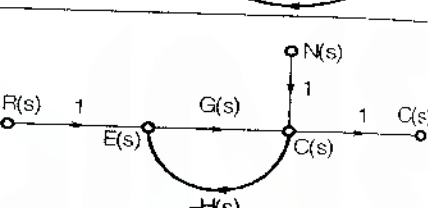
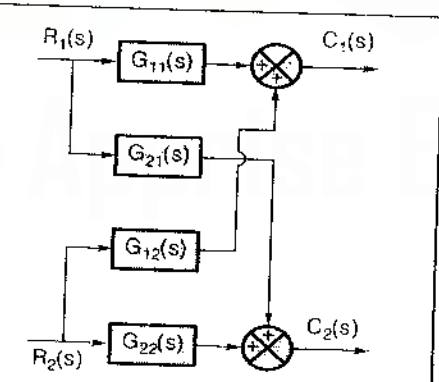
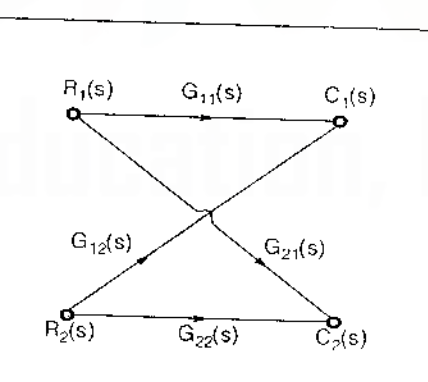
Original Block Diagram	Equivalent SFG
	
	
	
	
	

Mason's gain formula

$$P = \frac{1}{\Delta} \sum_k P_k \Delta_k$$

where, P = Overall gain or transfer function
 P_k = Path gain of k^{th} forward path
 $\Delta = 1 - (\text{sum of loop gains of all individual loops}) + (\text{sum of gain products of all possible combinations of two non-touching loops}) - (\text{sum of gain products of all possible combinations of three non-touching loops}) + \dots$
 Δ_k = Value of Δ obtained by removing all the loops touching k^{th} forward path

Note:

- Forward path is a path that can be traced through the graph from the input node to the output node without touching a node twice.
- Path gain is the product of all branch gain in a path.
- The individual loop is a closed path starting and ending at the same node.
- Loop gain is the product of all branch gains in a loop.
- Non touching loops are loops which do not have a common node.

Sensitivity

$$\text{Sensitivity} = \frac{\% \text{ change in } A}{\% \text{ change in } K}$$

$$S_K^A = \frac{\partial A / A}{\partial K / K} = \frac{\partial A}{\partial K} \times \frac{K}{A}$$

where, S_K^A = Sensitivity of variable A with respect to parameter K

Note:

It is preferable that the sensitivity function S_K^A should be minimum.

1. Sensitivity of Overall Transfer Function $M(s)$ With Respect to Forward Path Transfer Function $G(s)$

- For open loop control system

$$S_G^M = \frac{G(s)}{M(s)} \cdot \frac{\partial M(s)}{\partial G(s)} = 1$$

- For closed loop control system

$$S_G^M = \frac{1}{1 + G(s)H(s)}$$

2. Sensitivity of Overall Transfer Function $M(s)$ With Respect to Feedback Path Transfer Function $H(s)$

$$S_H^M = - \frac{G(s)H(s)}{1 + G(s)H(s)}$$

Note:

Closed loop system is lesser sensitive to parameter variation. Hence, closed loop system is better.



Time Response Analysis of Control System

4

The time response of a control system means as to how a system behaves in accordance with time when a specified input test signal is applied.

The time response of a control system is divided in two parts:

- (i) Transient response
- (ii) Steady state response

Transient part of time response reveals the nature of response and its speed, where as steady state part of time response reveals the accuracy of a control system.

Standard Input Test Signals

(a) Step function



where,

$$u(t) = \begin{cases} 1 & ; t \geq 0 \\ 0 & ; t < 0 \end{cases}$$

(b) Ramp function

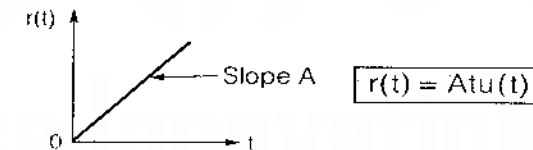

(c) Parabolic function

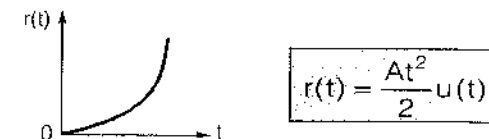

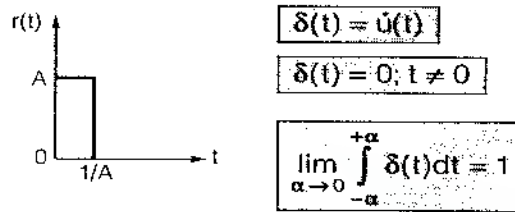
(d) Impulse Function**Time response of a first order control system**

□ Transfer Function

$$\frac{C(s)}{R(s)} = \frac{1}{sT + 1}$$

(i) Subjected to Unit Step Input Function

$$C(s) = \frac{1}{s(sT + 1)}$$

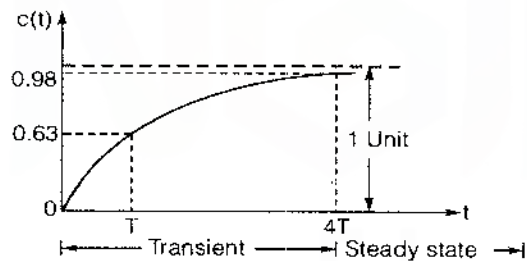

□ Time response expression

$$c(t) = \mathcal{L}^{-1}C(s) = 1 - e^{-t/T}$$

□ Error

$$e(t) = r(t) - c(t) = e^{-t/T}$$

□ Steady state error

$$e_{ss} = \lim_{t \rightarrow \infty} e^{-t/T} = 0$$

Note:

Lower the time constant, faster is the time response of a control system.

Subjected to Unit Ramp Input Function

□ Time response expression

$$c(t) = (t - T + Te^{-t/T})$$

□ Error

$$e(t) = r(t) - c(t) = (T - Te^{-t/T})$$

□ Steady State Error

$$e_{ss} = \lim_{t \rightarrow \infty} (T - Te^{-t/T}) = T$$

Subjected to Unit Impulse Input Function

□ Time response expression

$$c(t) = \frac{1}{T} e^{-t/T}$$

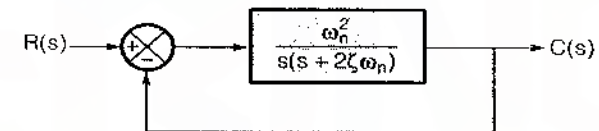
Time Response of Second Order Control System

□ Transfer function

$$\frac{C(s)}{R(s)} = \frac{\omega_n^2}{s^2 + 2\zeta\omega_n s + \omega_n^2}$$

where, ω_n = Natural frequency of oscillations

ζ = Damping ratio

$\zeta\omega_n$ = Damping factor

□ Damped frequency

$$\omega_d = \omega_n \sqrt{1 - \zeta^2}$$

where, ω_d = Damped frequency of oscillations

Subjected to Unit Step Input Function

□ Time response expression

Case-1: $\zeta < 1$ i.e. underdamped oscillations

$$c(t) = 1 - \frac{e^{-\zeta\omega_n t}}{\sqrt{1-\zeta^2}} \sin(\omega_d t + \phi)$$

$$\phi = \tan^{-1} \left(\frac{\sqrt{1-\zeta^2}}{\zeta} \right)$$

Note:

- Response settles within 2% of the desired value (1 unit) after damping out the oscillations in a time $4T$ (or $4/\zeta\omega_n$).

Case-2: $\zeta = 0$ i.e. sustained (undamped) Oscillations

$$c(t) = (1 - \cos \omega_n t)$$

Case-3: $\zeta = 1$ i.e. critically Damped Oscillations

$$c(t) = [1 - e^{-\omega_n t}(1 + \omega_n t)]$$

Case-4: $\zeta > 1$ i.e. overdamped Oscillations

$$c(t) = 1 - \frac{e^{-(\zeta - \sqrt{\zeta^2 - 1})\omega_n t}}{(2\sqrt{\zeta^2 - 1})(\zeta - \sqrt{\zeta^2 - 1})}$$

□ Time constant of the response

$$T = \frac{1}{(\zeta - \sqrt{\zeta^2 - 1})\omega_n}$$

Effect of ξ on Time Response

SNo.	Value of ξ	Type of closed poles	Nature of response	System classification
1.	$\xi = 0$	Purely imaginary	Oscillations with constant frequency and amplitude	Undamped
2.	$0 < \xi < 1$	Complex conjugate	Damped oscillation	Underdamped
3.	$\xi = 1$	Real, equal and negative	Critical and pure exponential	Critically damped
4.	$1 < \xi < \infty$	Real, unequal and negative	Purely exponential slow and sluggish	Overdamped

Pole Locations for Different Cases, for a Second Order System

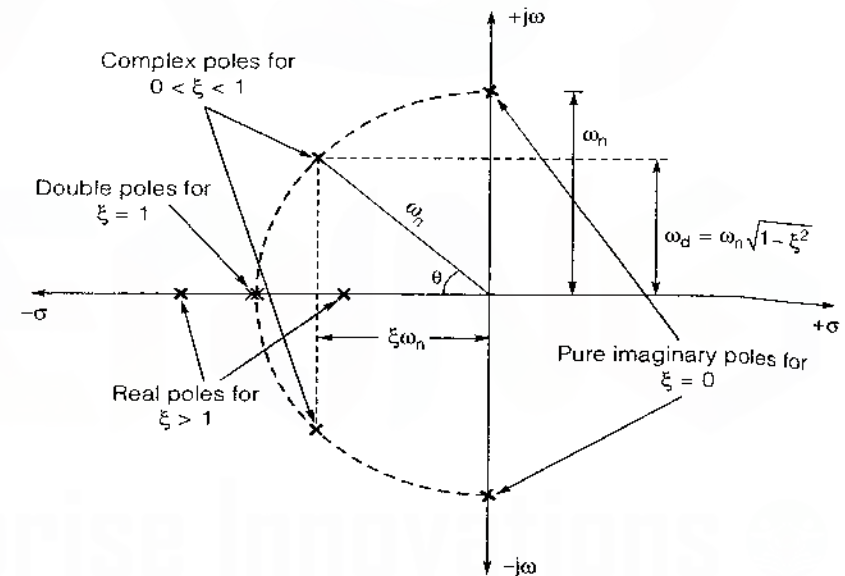

Note:

- As ξ increases from 0 to 1 then the frequency of oscillation reduces.
- For all positive value of ξ , system are stable.
- Pole away from origin called insignificant pole, and does not affect the stability of system.
- $\theta = \cos^{-1} \xi$.

Some Practical Example of Second Order System

Series RLC Circuit	Parallel RLC Circuit	Translatory System	Rotational System
Characteristic equation $s^2 + \frac{R}{L}s + \frac{1}{LC} = 0$	Characteristic equation $s^2 + \frac{1}{RC}s + \frac{1}{LC} = 0$	Characteristic equation $s^2 + \frac{f}{M}s + \frac{K}{M} = 0$	Characteristic equation $s^2 + \frac{f}{J}s + \frac{K}{J} = 0$
$\omega_n = \frac{1}{\sqrt{LC}}$	$\omega_n = \frac{1}{\sqrt{LC}}$	$\omega_n = \sqrt{\frac{K}{M}}$	$\omega_n = \sqrt{\frac{K}{J}}$
$\xi = \frac{R}{2\sqrt{L/C}}$	$\xi = \frac{1}{2R\sqrt{C/L}}$	$\xi = \frac{f}{2\sqrt{KM}}$	$\xi = \frac{f}{2\sqrt{KJ}}$

Transient Response Specifications of Second Order Control System

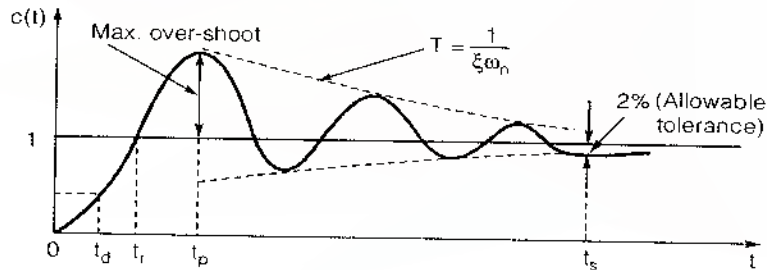

1. Delay Time (t_d)

It is the time require for the response to rise from 0 to 50% of the final value.

$$t_d = \frac{1 + 0.7\xi}{\omega_n}$$

2. Rise Time (t_r)

It is the time required for the response to rise from

0 to 100% (underdamped) → for underdamped system

5 to 95% (critical damped) → for critically damped system

10 to 90% (over damped) → for overdamped system

of the final value

$$t_r = \frac{\pi - \tan^{-1}\left(\frac{\sqrt{1-\xi^2}}{\xi}\right)}{\omega_d} = \frac{\pi - \cos^{-1}\xi}{\omega_d} \text{ radian}$$

3. Peak Time (t_p)

It is the time required for the response to rise from zero to peaks of the time response.

$$t_p = \frac{n\pi}{\omega_d}$$

where, $n = 1, 2, 3, \dots$

for $n = 1$, first overshoot

$n = 2$, first undershoot

4. Settling Time (t_s)

It is the time require for response to rise and reach to the tolerance band

For 2% tolerance band,

$$t_s = 4\tau = \frac{4}{\xi\omega_n}$$

For 5% tolerance band,

$$t_s = 3\tau = \frac{3}{\xi\omega_n}$$

5. Peak Over Shoot (M_p)

It gives the normalised difference between the steady state output to first peak of the time response.

$$\%M_p = e^{-\frac{\pi\xi}{\sqrt{1-\xi^2}}} \times 100\%$$

Note:

- The time period of the oscillation before reaching the steady state.

$$T_{\text{oscillation}} = \frac{2\pi}{\omega_d}$$

- Number of oscillation before reaching steady state is

$$N = \frac{T_{\text{settling}}}{T_{\text{oscillation}}}$$

Types and Order of System

- Every Transfer function representing the control system has certain type and order.
- The steady state analysis depends on type of the system.
- The type of the system is obtain from open loop transfer function i.e. $G(s) H(s)$.
- The number of open loop poles occurring at origin determines the type of the system.

$$\text{Let } G(s) H(s) = \frac{K(1+sT_a)}{s^P(1+sT_1)}$$

For $P = 0$ for Type-0 system
 $P = 1$ for Type-1 system
 $P = n$ for Type-n system

- Transient state analysis depends on order of the system.
- The order of system is obtain from closed loop transfer function i.e.

$$\frac{G(s)}{1 + G(s)H(s)}$$

- The highest power of characteristic equation, i.e. $1 + G(s) H(s) = 0$ determines the order of control system.

Steady State Error

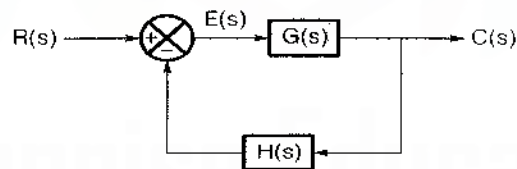

$$E(s) = \frac{R(s)}{1 + G(s)H(s)}$$

Steady state error, $e_{ss} = \lim_{t \rightarrow \infty} e(t)$ (in time-domain)

$$e_{ss} = \lim_{s \rightarrow 0} sE(s) \quad (\text{in s-domain})$$

$$e_{ss} = \lim_{s \rightarrow 0} s \frac{R(s)}{1 + G(s)H(s)}$$

$$e_{ss} = \frac{\lim_{s \rightarrow 0} sR(s)}{1 + \lim_{s \rightarrow 0} G(s)H(s)}$$

Note:

Steady state error depends on two factor:

- Type of input applied i.e. $R(s)$.
- Type of system i.e. $G(s) H(s)$.

1. Steady State Error for Different Types of Input

(i) Step input

$$R(s) = \frac{A}{s}$$

$$e_{ss} = \frac{A}{1 + K_p}$$

$$K_p = \lim_{s \rightarrow 0} G(s)H(s)$$

where, $K_p =$ Static position error constant

(ii) Ramp input

$$R(s) = \frac{A}{s^2}$$

$$e_{ss} = \frac{A}{K_v}$$

$$K_v = \lim_{s \rightarrow 0} sG(s)H(s)$$

where, $K_v =$ Static velocity error constant

(iii) Parabolic input

$$R(s) = \frac{A}{s^3}$$

$$e_{ss} = \frac{A}{K_a}$$

$$K_a = \lim_{s \rightarrow 0} s^2 G(s)H(s)$$

where, K_a = Static acceleration error constant

2. Steady State Error for Different Types of System

Type	Step input	Ramp input	Parabolic input
Type-0	$\frac{A}{1+K}$	∞	∞
Type-1	0	$\frac{A}{K}$	∞
Type-2	0	0	$\frac{A}{K}$

Where, K is the system gain.

Observation

- (i) $e_{ss} \propto \frac{1}{K}$, so, as system gain increases, steady state error decreases.
- (ii) For Linear Time Invariant (LTI) system, the maximum type number is two. Beyond type-2, the system exhibits non-linear characteristics.

Note:

- Steady state error is valid only for closed loop stable system'
- Steady state error are calculated to the closed loop system by using open loop transfer function.



Stability in Time-Domain

5

Stability

A Linear Time Invariant (LTI) system is said to be stable if the following conditions are satisfied:

- (i) If the system is excited by a bounded input, the output must be bounded.
- (ii) If input to the system is zero, the output must be zero, irrespective of all the initial condition.

Marginal Stable System

A LTI system is said to be marginal stable if for the bounded input, the output maintains the constant amplitude and frequency.

Absolute Stable System

System is stable for all the value of system gain (K) from 0 to ∞ .

Conditional Stable System

System is stable for a certain range of K.

Routh Hurwitz (R-H) Criteriaon

Purpose

1. To find out closed loop system stability.
2. Number of closed loop pole in right side or left side of the s-plane.
3. Range of K for conditionally stable system.
4. Value of K required for marginal stability and thereby, determine the frequency of oscillations.

Note:

To find a closed loop system stability by using R-H criteria we need characteristic equation.

Routh Array

- General n^{th} order characteristics equation is
 $a_0 s^n + a_1 s^{n-1} + a_2 s^{n-2} + \dots + a_{n-1} s^1 + a_n = 0$
- Routh array

s^n	a_0	a_2	a_4	\dots
s^{n-1}	a_1	a_3	a_5	\dots
s^{n-2}	$\frac{a_1 a_2 - a_0 a_3}{a_1}$	$\frac{a_1 a_4 - a_0 a_5}{a_1}$	\dots	\dots
\vdots	\vdots	\vdots	\vdots	\vdots
s^0	a_n	\dots	\dots	\dots

- For closed loop system to be stable, all the coefficient in the first column must be positive and there should not be any missing coefficient in the first column.
- If there is any sign change in the first column of the Routh array then system is unstable.
- Number of sign changes is equal to number of roots lie in the right side of the s -plane.

Note:

- Magnitude and sign of every term in each row and column depend on first column element, therefore we always see first column term.
- Row zero occurs only when all the poles are located symmetrical about origin.
- The presence of a zero in the first column of the Routh's tabulation leads to following conclusions
 - Equal real roots with opposite signs.
 - Pair of conjugate roots on imaginary axis.

Difficulties and Limitations of Routh Array

- The routh array is applicable to LTI system only.
- It determines poles in LHS or RHS of s -plane but not their exact location.
- Whenever any one coefficient is zero in first column then replace zero by smallest positive constant (ϵ) and continue the Routh array, finally substitute $\epsilon = 0$ and check for the sign change.

- When routh array ends abruptly, construct an auxiliary equation and differentiate it to get new coefficient to complete the routh array.
- When the system is marginally stable, find the frequency of sustain oscillations form auxiliary equation. The auxiliary equation should be an even polynomial of order two only.

Root Locus

Root locus is defined as the locus of closed loop poles obtained when system gain K varied from 0 to ∞ .

Angle Condition

Angle condition is used for checking whether certain points lie on root locus or not and hence, the validity of root locus for closed loop poles. For a point to lie on root locus, the angle evaluated at that point must be an odd multiple of $\pm 180^\circ$ i.e. $\pm(2q + 1)180^\circ$.

Magnitude Condition

The magnitude condition is used for finding the system gain K at any point on root locus.

$$|G(s)H(s)| = 1$$

Construction Rules of Root Locus

- Root locus is symmetrical about real axis.
- Let P = Number of open loop poles
 Z = Number of open loop zeros
 If $p > z$
 then (a) The number of branches of root locus = P
 (b) The number of branches terminating at zero = Z
 (c) The number of branches terminating at infinity = $P - Z$
- A point on real axis is said to be on root locus if, to the right side of this point, the sum of open loop poles and zeros is an odd number.
- Angle of Asymptotes**

$$\square \text{ Number of asymptotes} = P - Z$$

$$\square \text{ Angle of asymptotes} = \frac{(2q + 1)180^\circ}{P - Z} \quad (\text{where, } q = 0, 1, 2, \dots)$$

5. Centroid

Centroid is the point of intersection of asymptote on the real axis.

$$\text{Centroid} = \frac{\Sigma \text{Real part of open loop poles} - \Sigma \text{Real part of open loop zeros}}{P - Z}$$

6. Break away point

They are the points where multiple roots of characteristic equation occurs.

Procedure to find out break away point:

(a) Construct characteristic equation i.e. $1 + G(s)H(s) = 0$.

(b) Write K in terms of s.

(c) Find $\frac{dK}{ds}$.

(d) The root of $\frac{dK}{ds} = 0$ give break away points.

7. Intersection of root locus with imaginary axis

Roots of auxiliary equation at $K = K_{(\text{marginal})}$ from routh array gives intersection of root locus with imaginary axis.

8. Angle of departure and arrival

The angle of departure is tangent to the root locus at the complex poles.

$$\phi_D = 180^\circ + \phi$$

The angle of arrival is tangent to the root locus at the complex zero.

$$\phi_A = 180^\circ - \phi$$

$$\phi = \phi_z - \phi_p$$

where, ϕ_z = Sum of all the angles subtended by remaining zeros

ϕ_p = Sum of all the angle subtended by poles

Note:

Whenever the system transfer function consist of the poles at origin then the root locus is nothing but angle of asymptotes.

Effect of Addition of Pole

1. Operating range of K decreases for system to be stable.
2. Relative stability reduces.
3. System becomes more oscillatory.
4. The break away point shift towards the imaginary axis.
5. Damping factor decreases and system becomes unstable.
6. Settling time (T_s) and bandwidth increases.
7. Rise time (T_r) decreases.

Effect of Addition of Zero

1. System become stable.
2. Relative stability improved.
3. Range of K for stability increases.
4. System becomes less oscillatory.
5. Break away point shift towards the left side of the s-plane.
6. Damping factor increases.
7. Bandwidth decreases.



Industrial Controller

6

Types of Industrial Controller

1. Proportional Controller

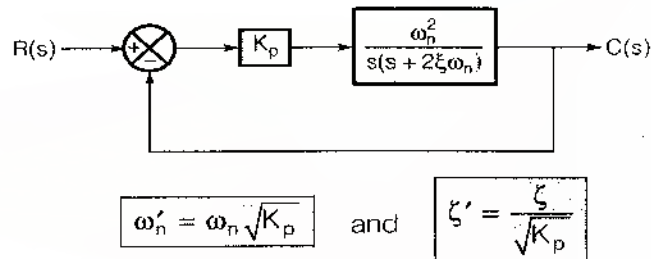

where, K_p = Proportional gain

Effect

- (i) Natural frequency of oscillation (ω_n) increases by $\sqrt{K_p}$.
- (ii) Damping ratio (ξ) decreases by $\sqrt{K_p}$.
- (iii) Peak overshoot (M_p) increases.
- (iv) Steady state error reduces.

2. Derivative Controller

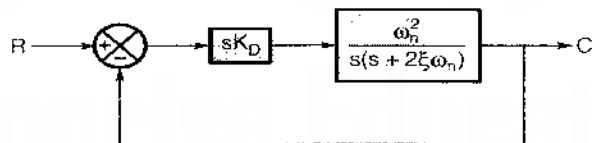

where, K_D = Rate constant

Effect

- (i) Type and order of the system reduces by one.
- (ii) Oscillations has died out, hence transient response improves.
- (iii) Not used in isolation.

Integral Controller

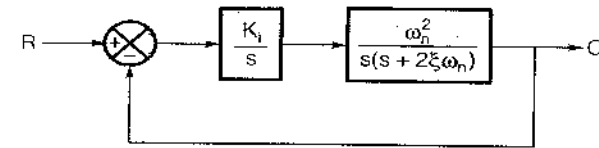

where, K_i = Integral scaling

Integral controller is a memory based controller.

Effect:

- (i) It increases type and order by one.
- (ii) Makes the system lesser stable.
- (iii) Steady state error reduces.
- (iv) It improves the steady state response.

4. P-D Controller

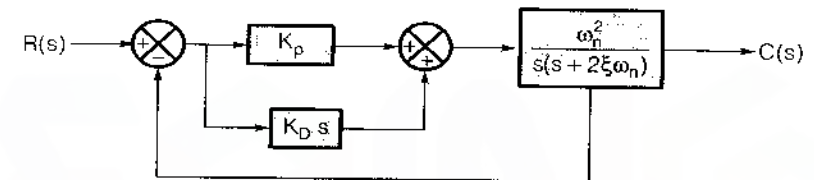

Effect:

- (i) Transient response improves.
- (ii) Damping ratio increases.
- (iii) Peak overshoot decreases.
- (iv) Bandwidth increases.
- (v) Noise level increases.
- (vi) Improves gain margin, phase margin and resonant peak.

5. P-I Controller

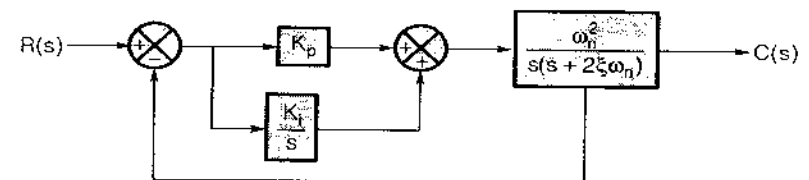

Effect

- (i) Improves steady state response.
- (ii) Improves type and order of system by one.
- (iii) Noise level reduces.
- (iv) Increases error constant.
- (v) Bandwidth reduces.

6. PID Controller

It is similar to lead-lag compensator and band reject filter.

Effect

- (i) It improves both steady state as well as transient response.
- (ii) It reduces rise-time.
- (iii) It increases bandwidth.
- (iv) It increases stability.
- (v) It eliminates steady state error between input and output.
- (vi) It increases type and order of system by one.

■■■■

**Compensator**

Compensator in control system are used for improving the performance specifications i.e. the transient and steady state response characteristics.

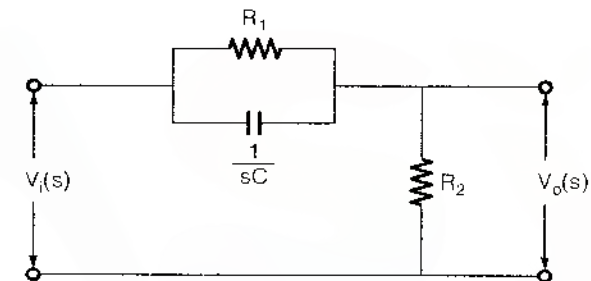
Lead Compensator

$$\frac{V_o(s)}{V_i(s)} = \frac{\alpha(1 + Ts)}{(1 + \alpha Ts)}$$

where,

$$T = R_1 C \quad \text{and} \quad \alpha = \frac{R_2}{R_1 + R_2} \quad (\alpha < 1)$$

Note:

- Zero is closer to origin than the pole.
- It is similar to the PD controller.

Effect of Lead Compensator

1. It improves the transient response.
2. It increases the margin of stability.
3. It increases the bandwidth.
4. $\left(\frac{\text{Signal}}{\text{Noise}}\right)_{\text{output}} < \left(\frac{\text{Signal}}{\text{Noise}}\right)_{\text{input}}$
5. It helps to increase error constant upto some extent.
6. It allows to pass high frequencies and low frequencies are attenuated.
7. Increase the phase shift.

LAG Compensator

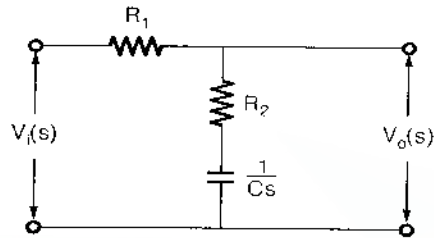

$$\frac{V_o(s)}{V_i(s)} = \frac{1 + Ts}{1 + \beta Ts}$$

where,

$$T = R_2 C \quad \text{and} \quad \beta = \frac{1}{\alpha} = \frac{R_1 + R_2}{R_2} \quad (\beta > 1)$$

Note:

- Pole is closer to origin than the zero.
- It is similar to the PI controller.

Effect of Lag Compensator

1. It improves the steady state response.
2. It increases the error constant.
3. It decreases the bandwidth.
4. It reduces the effect of noise.
5. It reduces the stability margin.
6. It does not affect the transient response.
7. System become lesser stable.
8. It allows to pass low frequencies and attenuates the high frequencies.
9. Decreases the phase shift.

Lead-LAG/LAG-Lead Compensator

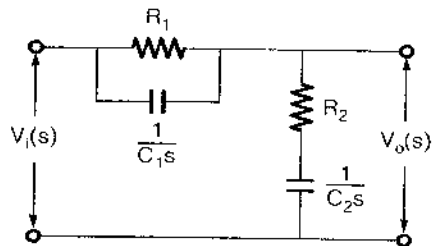

$$\frac{V_o(s)}{V_i(s)} = \frac{\alpha(1 + T_1 s)(1 + T_2 s)}{(1 + \alpha T_1 s)(1 + \beta T_2 s)}$$

where,

$$T_1 = R_1 C_1 \quad \text{and} \quad T_2 = R_2 C_2$$

$$\alpha = \frac{R_2}{R_1 + R_2} \quad \text{and} \quad \beta = \frac{R_1 + R_2}{R_2}$$

Effect of lead-lag/lag-lead compensator

Lead-Lag network improves both steady state and transient response of the system.

■■■■

Frequency Response Analysis

Frequency response analysis implies varying ω from zero to ∞ and observing corresponding variation in magnitude and phase angle of the response.

Frequency Response Analysis for Second Order System

Transfer Function

$$\frac{C(s)}{R(s)} = \frac{\omega_n^2}{s^2 + 2\xi\omega_n s + \omega_n^2}$$

Resonant Frequency

It is defined as, the frequency at which the magnitude has maximum value.

$$\omega_r = \omega_n \sqrt{1 - 2\xi^2}$$

Resonant Peak

It is maximum value of magnitude occurring at resonant frequency ω_r .

$$|M_r| = \frac{1}{2\xi\sqrt{1 - \xi^2}}$$

Phase Angle at Resonant Frequency

$$\phi_r = -\tan^{-1} \left[\frac{\sqrt{1 - 2\xi^2}}{\xi} \right]$$

Remember:

- As ξ approaches zero, ω_r approaches ω_n and M_r approaches to infinity.
- For $0 < \xi \leq 1/\sqrt{2}$, the resonant frequency always has a value less than ω_n and the resonant peak has a value greater than 1.

Cut-off Frequency and Bandwidth

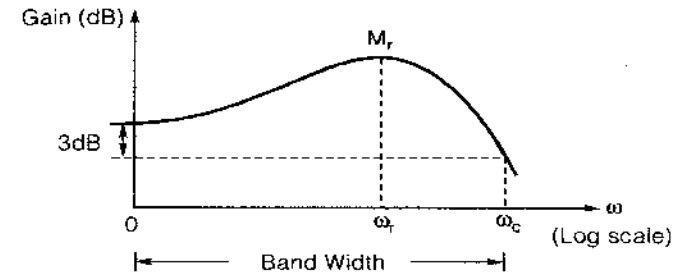

□ Cut-off frequency

$$\omega_c = \omega_n \left[1 - 2\xi^2 + \sqrt{4\xi^4 - 4\xi^2 + 2} \right]^{1/2}$$

□ Bandwidth

$$\text{B.W.} = \omega_c$$

Stability from Frequency Response Plot

□ Phase Margin (P.M.)

$$\text{P.M.} = 180^\circ + \angle G(j\omega) H(j\omega)$$

...at gain cross over frequency

□ Gain Margin (G.M.)

$$\text{G.M.} = \frac{1}{|G(j\omega) H(j\omega)|_{\omega=\omega_{pc}}} = \frac{1}{X}$$

... at phase crossover frequency

$$\text{G.M. (dB)} = 20 \log \left(\frac{1}{X} \right)$$

Remember:

- **For stable systems**
 - (i) Gain cross over frequency < phase cross-over frequency
 - (ii) G.M. and P.M. both are positive
- **For unstable systems**
 - (i) Gain cross over frequency > phase cross-over frequency
 - (ii) G.M. and P.M. both are negative
- **For marginally stable systems**
 - (i) Gain cross over frequency = Phase cross-over frequency
 - (ii) G.M. and P.M. both are zero

G.M. and P.M. for Second Order System

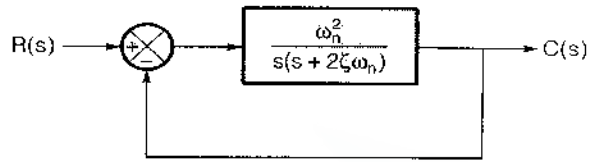

□ Gain cross-over frequency

$$\omega_{gc} = \omega_n \sqrt{-2\zeta^2 + \sqrt{4\zeta^4 + 1}}$$

□ Phase margin

$$P.M. = \tan^{-1} \left[\frac{2\zeta}{\sqrt{-2\zeta^2 + 4\zeta^4 + 1}} \right] \approx 100\zeta$$

Polar Plot

It is a plot of absolute values of magnitude and phase angle in degree of open loop transfer function $G(j\omega)H(j\omega)$ versus ω drawn on polar coordinates.

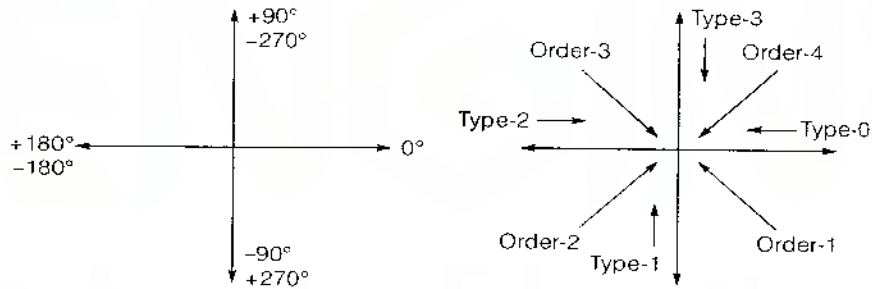

General Shapes of Polar Plot

1. Type-0/Order-1

$$G(s) = \frac{1}{1 + Ts}$$

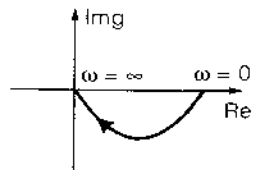

2. Type-0/Order-2

$$G(s) = \frac{1}{(1 + T_1s)(1 + T_2s)}$$

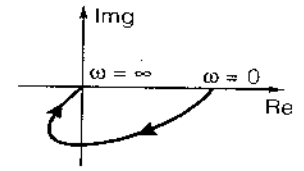

3. Type-0/Order-3

$$G(s) = \frac{1}{(1 + T_1s)(1 + T_2s)(1 + T_3s)}$$

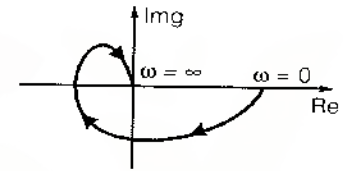

4. Type-0/Order-4

$$G(s) = \frac{1}{(1 + T_1s)(1 + T_2s)(1 + T_3s)(1 + T_4s)}$$

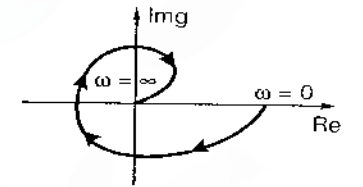

5. Type-1/Order-1

$$G(s) = \frac{1}{s}$$

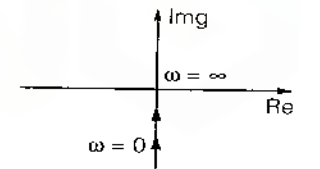

6. Type-1/Order-2

$$G(s) = \frac{1}{s(1 + Ts)}$$

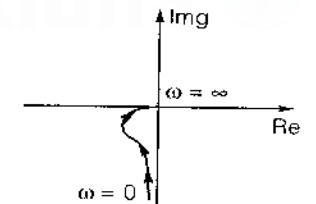

7. Type-1/Order-3

$$G(s) = \frac{1}{s(1+T_1s)(1+T_2s)}$$

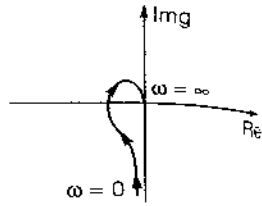

8. Type-1/Order-4

$$G(s) = \frac{1}{s(1+T_1s)(1+T_2s)(1+T_3s)}$$

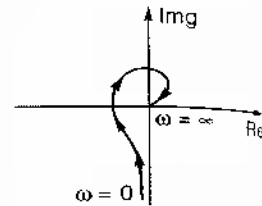

9. Type-2/Order-2

$$G(s) = \frac{1}{s^2}$$

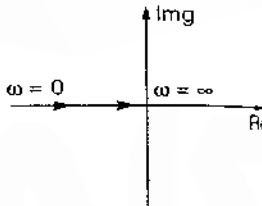

10. Type-2/Order-3

$$G(s) = \frac{1}{s^2(1+Ts)}$$

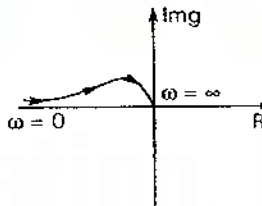

11. Type-2/Order-4

$$G(s) = \frac{1}{s^2(1+T_1s)(1+T_2s)}$$

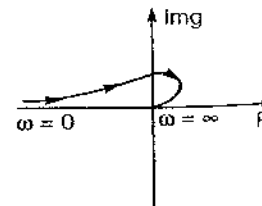

12. Type-3/Order-3

$$G(s) = \frac{1}{s^3}$$

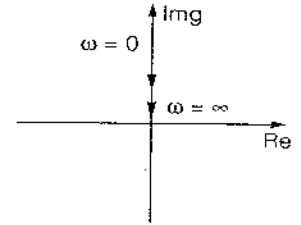

13. Type-3/Order-4

$$G(s) = \frac{1}{s^3(1+Ts)}$$

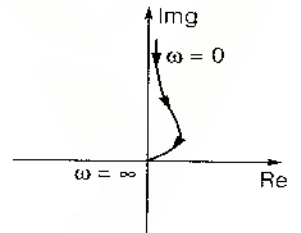

Note:

- For standard transfer function of type-2 and type-3 systems, the polar plot intersects negative real axis as many times as there are zeros in open loop transfer function.

Nyquist Stability Criteria

Open loop transfer function

$$G(s)H(s) = \frac{K(s \pm Z_1)}{s(s \pm P_1)}$$

$$1 + G(s)H(s) = 0$$

$$1 + \frac{K(s \pm Z_1)}{s(s \pm P_1)} = 0$$

$$\frac{s(s \pm P_1) + K(s \pm Z_1)}{s(s \pm P_1)} = 0 \quad \dots(i)$$

Nyquist stability criteria states that the number of encirclements about the critical point $(-1 + j0)$ should be equal to poles of open loop transfer function $G(s)H(s)$, which are in the right half of s -plane.

i.e.

$$N = P - Z$$

For stability

(i) $Z = 0$

and (ii) $N = P$

where,

 P = Number of open loop poles in RHS of s-plane Z = Number of closed loop poles in RHS of s-plane N = Number of encirclements about of the point $(-1 + j0)$ by $G(s)H(s)$ plot. The positive direction of encirclements being anti-clockwise.

Bode Plot

The variation of magnitude of sinusoidal transfer function expressed in decibel and the corresponding phase angle in degrees being plotted with frequency on a logarithmic scale in rectangular axis. The plot thus obtained is known as Bode plot.

Procedure to Draw Bode Plot

- s is replaced by $j\omega$ to convert into frequency domain.
- Find magnitude in terms of ω and write in terms of dB.

$$\text{Magnitude in dB} \quad M_{dB} = 20 \log |G(j\omega)H(j\omega)|$$

- Find the phase angle $\angle\phi$

$$\angle\phi = \tan^{-1} \left(\frac{\text{imaginary part}}{\text{real part}} \right)$$

- With required approximation by varying the frequency minimum to maximum, draw the magnitude and phase plot.

$$\square \text{ If } G(s)H(s) = K$$

then

$$|M_{dB}| = 20 \log K$$

System gain K shift the magnitude plot either in upward or downward by " $20 \log K$ ".

- Slope

$$\text{Slope} = \frac{d|M|_{dB}}{d \log \omega}$$

Note:

- The magnitude plot should be started at the frequency of 0.1 with opposite sign of the slope and it should be passes through 0 dB line and intersect at $\omega = 1$, when $K = 1$.

- n poles at origin gives

$$\text{Slope} = -20n \text{ dB/dec}$$

$$\angle\phi = -90n^\circ$$

- n zeros at origin gives

$$\text{Slope} = +20n \text{ dB/dec}$$

$$\angle\phi = +90n^\circ$$

Remember:

- The initial slope of the magnitude plot is given by the poles or zero located at origin.

- Corner frequency

The frequency at which slope changes from one level to another level. Corner frequencies are nothing but a finite poles and finite zeroes location in the form of magnitude.

$$\square \text{ If } G(s)H(s) = \frac{1}{(1 + sT)^n}$$

Frequency	Slope	Phase (ϕ)
Below corner frequency	0	0
Above corner frequency	-20n dB/dec	-90n°

$$\square \text{ If } G(s)H(s) = (1 + sT)^n$$

Frequency	Slope	Phase (ϕ)
Below corner frequency	0	0
Above corner frequency	20n dB/dec	90n°

Error

Maximum error between the exact and asymptotic plot occurs at corner frequency

Frequency	Error in magnitude plot	Error in phase plot
$\frac{0.1}{T}$	0 dB	-5.6°
$\frac{0.5}{T}$	0.96 dB	-26.56°
$\frac{1}{T}$	3 dB	-45°
$\frac{10}{T}$	0 dB	-5.6°

Remember:

- The error is nothing but difference between actual value and asymptotic value.
- Error is maximum at corner frequency.
- Error is even function w.r.t. corner frequency.
- 6 dB/oct = 20 dB/dec.

Classification of system**1. Minimum Phase System**

A system in which all finite poles and finite zeros are located in left half of s-plane then it is called as minimum phase system.

2. Non Minimum Phase System

A system in which one or more zeros lies in the right half of s-plane, remaining all the poles and zeros lies on the left half of s-plane.

3. All Pass System

A system in which zeros lies on the right half of s-plane, poles lies on the left half of s-plane and which are symmetrical about imaginary axis. For all pass system magnitude should be 1 and phase angle is -180° .

Note:

- Non minimum system = Minimum phase system * all pass system
- $\angle\phi_{MNPS} = \angle\phi_{MPS} + \angle\phi_{ALP}$

Constant Magnitude Loci (M-circles)

- Radius of M-circles

$$\text{Radius} = \frac{M}{1-M^2}$$

- Centre of M-circles

$$\text{Centre} = \left(\frac{M^2}{1-M^2}, 0 \right)$$

Constant Phase Angles Loci (N-circles)

- Radius of N-circles

$$\text{Radius} = \sqrt{\frac{1}{4} + \frac{1}{4N^2}}$$

- Centre of N-circles

$$\text{Centre} = \left(-\frac{1}{2}, \frac{1}{2N} \right)$$

■■■■

State Space Analysis

General Representation of State Model

□ State equation

$$\dot{x} = Ax + Bu$$

□ Output equation

$$y = Cx + Du$$

where, \dot{x} = Velocity vector ($n \times 1$)
 x = State vector ($n \times 1$)
 u = Input vector ($m \times 1$)
 y = Output vector ($p \times 1$)
 A = State matrix ($n \times n$)
 B = Input matrix ($n \times m$)
 C = Output matrix ($p \times n$)
 D = Transmission matrix ($p \times m$)
 n = Number of state variables
 p = Number of outputs
 m = Number of inputs

Controllability

$$Q_c = [B : AB : A^2B : \dots : A^{n-1}B]$$

where, Q_c = Controllability test matrix ($n \times nm$)

Condition for State Controllability

$$|Q_c| \neq 0 \dots \text{(Matrix be non singular)}$$

Observability

$$Q_o = [C^T : A^T C^T : (A^T)^2 C^T : \dots : (A^T)^{n-1} C^T]$$

where, Q_o = Observability test matrix ($n \times np$)

Condition for State Observability

$$|Q_o| \neq 0 \dots \text{(Matrix be non singular)}$$

Note:

- If AB is controllable, $A^T B^T$ is observable.
- If AC is observable, $A^T C^T$ is controllable.
- If input-output transfer function of a linear time invariant system does not have pole-zero cancellation, the system can always be represented by completely controllable and observable state model.

□ Transfer function (T.F.)

$$\text{T.F.} = C[sI - A]^{-1}B + D$$

State transition matrix (STM)

$$e^{At} \equiv \phi(t) = L^{-1}[(sI - A)^{-1}]$$

Properties of STM

- (i) $\phi(0) = I$ (identity matrix)
- (ii) $\phi^{-1}(t) = \phi(-t)$
- (iii) $[\phi(t)]^K = \phi(Kt)$
- (iv) $\phi(t_1 + t_2) = \phi(t_1) \phi(t_2)$
- (v) $\phi(t_2 - t_1) \phi(t_1 - t_0) = \phi(t_2 - t_0)$
- (vi) $\dot{\phi}(t) = A\phi(t)$



A Handbook on Electrical Engineering

7

Signals and Systems

CONTENTS

1. Introduction to Signals	387
2. Linear Time Invariant Systems	396
3. Fourier Series	400
4. Fourier Transform	405
5. Laplace Transform	408
6. Z -Transform	413



Introduction to Signals

1

Signals

A signal can be defined as a function of one or more independent variable, which conveys information about the behaviour or nature of some phenomenon.

Elementary Signals

1. Unit step function

(a) For continuous time

$$u(t) = \begin{cases} 1 & ; t > 0 \\ 0 & ; t < 0 \end{cases}$$

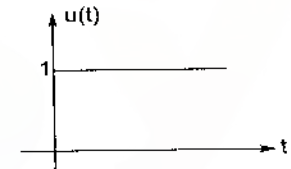

(b) For discrete-time

$$u[n] = \begin{cases} 1 & ; n \geq 0 \\ 0 & ; n < 0 \end{cases}$$

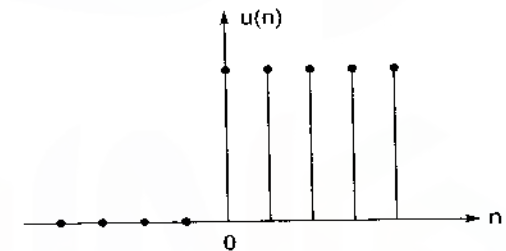

Remember:

- Extension of wire result into increase in resistance while compression of wire result into decrease in resistance.

- Mathematically $u(0) = \frac{1}{2}$; average value

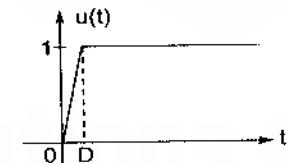

2. Unit impulse function

(a) For continuous time

$$\delta(t) = \begin{cases} \infty & ; t = 0 \\ 0 & ; t \neq 0 \end{cases}$$

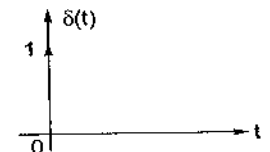

Properties of the impulse function

- (i) Impulse function is a continuous function and the area under this function is equal to one

$$\int_{-\infty}^{\infty} \delta(t) dt = 1$$

- (ii) Even function of time

$$\delta(-t) = \delta(t)$$

- (iii) $\delta(at) = \frac{1}{|a|} \delta(t)$

- (iv) Product :

$$x(t) \delta(t - t_0) = x(t_0) \delta(t - t_0); \text{where, } t_0 \text{ is time shift}$$

- (v) Sampling property :

$$\int_{t_1}^{t_2} x(t) \delta(t - t_0) dt = x(t_0); \quad t_1 < t_0 < t_2$$

- (vi) $\int_{-\infty}^{\infty} \frac{d\delta(t)}{dt} x(t) dt = \frac{dx(t)}{dt} \Big|_{t=0}$

Relationship between unit impulse and unit step function

$$u(t) = \int_{-\infty}^t \delta(t) dt \quad \text{and} \quad \delta(t) = \frac{du(t)}{dt}$$

Remember:

- As the unit step function is neither continuous nor differentiable at $t = 0$. The unit impulse function is defined as

$$\delta_{\Delta}(t) = \frac{du_{\Delta}(t)}{dt}$$

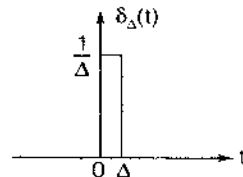

- $\delta(t)$ is the limit as $\Delta \rightarrow 0$ of $\delta_{\Delta}(t)$

(b) For discrete-time

$$\delta[n] = \begin{cases} 1 & ; n = 0 \\ 0 & ; n \neq 0 \end{cases}$$

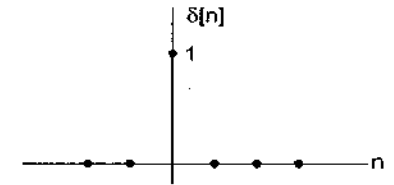

Remember:

- The discrete-time unit impulse is the first difference of the discrete-time unit step

$$\delta[n] = u[n] - u[n-1]$$

- Relationship between unit impulse and unit step

$$u[n] = \sum_{k=0}^{\infty} \delta[n-k]$$

- Sampling property

$$x[n] \delta[n - n_0] = x[n_0] \delta[n - n_0]$$

3. Rectangular or Gate function

$$x(t) = \begin{cases} A & ; -T/2 < t < T/2 \\ 0 & ; \text{otherwise} \end{cases}$$

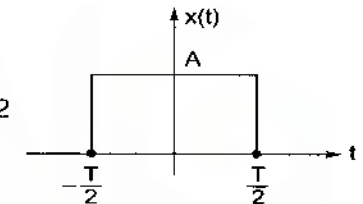

4. Unit Ramp function

$$r(t) = \begin{cases} t & ; t > 0 \\ 0 & ; t < 0 \end{cases}$$

$$\frac{d}{dt} r(t) = u(t)$$

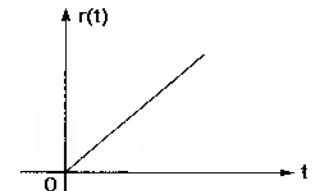

5. Signum or sgn function

$$\text{sgn}(t) = 2u(t) - 1$$

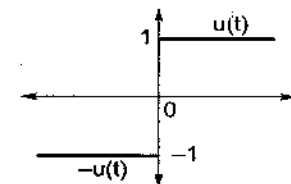

Note:

- $u(-t) = 1 - u(t)$
- Sgn function is not defined at $t = 0$ and is chosen as 0 at $t = 0$

6. Sinc and sinc² function

- The sinc and sinc² functions are defined in terms of an independent variable λ .

$$\text{sinc}(\lambda) = \frac{\sin(\pi\lambda)}{\pi\lambda}$$

- Sinc (λ) is equal to zero for $\lambda = \pm n$ ($n \neq 0$), n an integer.

7. Sine integral function

- Sine integral function is an odd function

$$\text{Si}(y) = \int_0^y \frac{\sin(\alpha)}{\alpha} d\alpha ; \quad \text{Si}(y) = \frac{y}{(1)!} - \frac{y^3}{(3)!} + \frac{y^5}{(5)!} - \frac{y^7}{(7)!} + \dots$$

Remember:

- $\text{Si}(a) = 0, \text{Si}(\pi) \cong 2.0123, \text{Si}(\infty) = \left(\frac{\pi}{2}\right)$
- Si function converges fast and only a few terms in above equation are needed for a good approximation

Operators**1. Time scaling****For analog signals**

Let $x(t)$ be an arbitrary signal, a time scaled version of $x(t)$ is obtained by replacing 't' by 'at' where 'a' is scaling factor.

$$\varphi(t) = x(at)$$

- $a > 1$ shows compression of $x(t)$.
- $0 < a < 1$ shows expansion of $x(t)$.

For discrete signals

For a discrete time sequence $x[n]$, compression of a signal by factor M is given by

$$\varphi[n] = x[Mn]; \quad M \text{ and } n \text{ both are integers}$$

2. Time Shifting**For analog signals**

Shifting in time may results in time delay or time advancement.

For a continuous-time signals $x(t)$, time shifting is given as

$$\varphi(t) = x(t - t_0) \quad \dots \quad \text{delay or shift right by 't}_0\text{'}$$

$$\varphi(t) = x(t + t_0) \quad \dots \quad \text{advance or shift left by 't}_0\text{'}$$

For discrete signals

For a discrete time sequence $x[n]$ time shifting is given as

$$\varphi[n] = x[n - n_0] \quad \dots \quad \text{delay or shift right by } n_0 \text{ samples.}$$

$$\varphi[n] = x[n + n_0] \quad \dots \quad \text{advance or shift left by } n_0 \text{ samples.}$$

3. Time Reversal**For analog signals**

Time reversal $x(t)$ is achieved by rotation of signal 180° about vertical axis. This operation is also called as folding or reflection about vertical axis.

For a continuous-time signals $x(t)$, time reversal is given as

$$\varphi(t) = x(-t)$$

For discrete signals

For discrete time sequence $x[n]$, time reversal is given as

$$\varphi[n] = x[-n]$$

Note:

- In priority order: Shifting > Scaling > Reversal
- There is no effect of scaling on unit step signal.
- The time scaling on ramp signal will result into magnitude scaling as

$$r(at) \longrightarrow ar(t)$$

Classification of Signals**1. Continuous time and discrete time signals**

$x(t)$ is a continuous-time signal if 't' is a continuous variable. But if 't' is a discrete variable that is $x(t)$ is defined at discrete times, then $x(t)$ is a discrete-time signal.

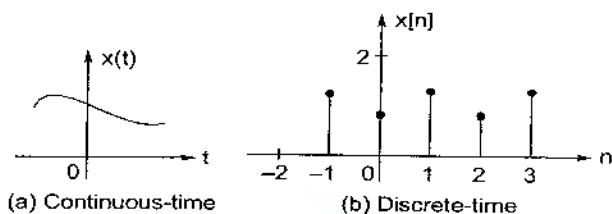

(a) Continuous-time

(b) Discrete-time

Note:

A discrete-time signal $x[n]$ may be obtained by sampling a continuous-time signal $x(t)$.

2. Analog and digital signals

If a continuous-time signal $x(t)$ can take on any value in the continuous interval (a, b) where 'a' may be $-\infty$ and 'b' may be $+\infty$, then the continuous time signal $x(t)$ is called an analog signal. If a discrete-time signal $x[n]$ can take on only a finite number of distinct value, then this signal is called a digital signal.

3. Real and complex signal

A signal $x(t)$ is a real signal if its value is a real number and a signal $x(t)$ is a complex signal if its value is a complex number.

4. Deterministic and Random signals

If $x(t)$ can be perfectly known for any time 't' then it is called deterministic signal. If $x(t)$ can not be exactly determined at any given time then it is called Random signal.

5. Even and Odd signals

A signal $x(t)$ or $x[n]$ is an even signal

$$\text{if } x(-t) = x(t)$$

$$x[-n] = x[n]$$

A signal $x(t)$ or $x[n]$ is referred to as an odd signal

$$\text{if } x(-t) = -x(t)$$

$$x[-n] = -x[n]$$

Note:

- The product of two even signals or of two odd signals is an even signal.
- The product of an even signal and an odd signal is an odd signal.

6. Energy and Power signals**(a) Energy of the signal**

$$E = \int_{-\infty}^{\infty} |x(t)|^2 dt$$

$$E = \sum_{n=-\infty}^{\infty} |x[n]|^2$$

(b) Average power of a signal

$$P = \lim_{T \rightarrow \infty} \frac{1}{T} \int_{-T/2}^{T/2} |x(t)|^2 dt$$

$$P = \lim_{N \rightarrow \infty} \frac{1}{2N+1} \sum_{n=-N}^N |x[n]|^2$$

Note:

- An energy signal has always zero average power.
- A power signal has infinite energy
- A signal maintain constant amplitude for all time is a power signal.
- If any signal is power signal for some time and it is energy signal for some other time then resultant signal is power signal.
- As $t \rightarrow \pm \infty$, if amplitude tends to ∞ , it is neither energy nor power signal.
- All finite duration and bounded signals are energy signal.
- Energy of a signal is only affected by scaling operation as

$$E(at) \longrightarrow \frac{E(t)}{a}$$

7. Periodic and Non Periodic signals

A continuous time signal $x(t)$ is said to be periodic with period T if there is a positive non zero value of T for which

$$x(t + T) = x(t); \quad \forall t$$

In discrete-time signal, a sequence $x[n]$ is periodic with period N , if there is a positive integer N for which

$$x[n + N] = x[n]; \quad \forall n$$

Note:

- The fundamental period for analog signal is

$$T_0 = \frac{2\pi}{\omega_0}$$

- For discrete signal

$$\frac{N}{K} = \frac{2\pi}{\omega_0}; \quad \text{where } K = 0, 1, 2, 3 \dots$$

- The fundamental period T_0 of $x(t)$ and N of $x[n]$ is the smallest positive integer for which above equation holds good.
- Sum of two continuous-time periodic signals may not be periodic but the sum of two periodic sequences is always periodic.

For periodic signal $x_T(t)$

- Average value of the signal

$$x_{\text{avg}} = \frac{1}{T} \int_T x_T(t) dt$$

- Average signal power

$$P_x = \frac{1}{T} \int_T |x_T|^2 dt$$

- Effective or rms value of the signal

$$x_{\text{rms}} = \sqrt{P_x}$$

Note:

- If $x_{T_1}(t)$ and $x_{T_2}(t)$ are two periodic functions with periods T_1 and T_2 , then

$x(t) = x_{T_1}(t) + x_{T_2}(t)$ is periodic with period T if

$$T = nT_1 = mT_2 \text{ or } \left[\frac{T_1}{T_2} \right] = \left[\frac{m}{n} \right]$$

where m and n are integers and $\left(\frac{T_1}{T_2} \right)$ is a rotational number.

- The period of $x(t)$ is equal the least common multiple (LCM) of T_1 and T_2 . The LCM of two integers m and n ; is the smallest integer divisible by both m and n .

Symmetries of periodic function**Half-wave symmetry**

A periodic function $x(t)$ is half-wave symmetric if

$$x_T(t) = -x_T\left(t - \frac{T}{2}\right)$$

where, T = Period of signal $x_T(t)$

- For even half-wave symmetry

$$x_T(t) = \begin{cases} x_T(-t) = x_T(t) \\ x_T(t) = -x_T\left(t + \frac{T}{2}\right) \end{cases}; x_T(t+T) = x_T(t)$$

- For odd half-wave symmetry

$$x_T(t) = \begin{cases} x_T(-t) = -x_T(t) \\ x_T(t) = -x_T\left(t + \frac{T}{2}\right) \end{cases}; x_T(t+T) = x_T(t)$$



A system is a quantity which maps a set of input signal to a set of output signals. Linear time invariant (LTI) systems are used to represent signals as linear combinations of basic signals.

Continuous-time and Discrete-time Systems

A continuous time system (CTS) is one in which continuous time input signals are transformed into continuous time output signals.

e.g. integrator, differentiator, filters etc.

A discrete time system (DTS) is one which transform discrete time input signal into discrete time output signal.

$$y[n] = T\{x[n]\}$$

Moreover, a continuous time signal can be processed by a discrete time system. On the other hand processing of discrete time signal by a continuous time system is also possible because discrete time systems have several significant advantages over continuous time systems.

Classification of Systems

1. Linear systems and non linear systems

When system satisfy principal of superposition and homogeneity, it is called linear system. Else non linear system.

(i) Superposition (Additivity)

$$\text{if } x_1(t) \rightarrow y_1(t)$$

$$x_2(t) \rightarrow y_2(t)$$

$$\text{then } x_1(t) + x_2(t) \rightarrow y_1(t) + y_2(t)$$

(ii) Homogeneity (Scaling)

$$ax_1(t) + bx_2(t) \rightarrow ay_1(t) + by_2(t)$$

2. Time-invariant and time varying systems

A system is called time-variant if a time shift in the input signal causes the same time-shift in the output signal.

$$\text{If } x(t) \rightarrow y(t)$$

$$\text{then } x(t - t_0) \rightarrow y(t - t_0)$$

3. Causal and non causal systems

The output of the causal system at the present time depends on only the present and/or past value of the input, not on its future values. A system is called non causal if it is not causal.

Note:

- All memory-less systems are causal, but not vice-versa.
- Causal system are referred as non-anticipative as the system output does not anticipate future values of input.

4. Static and dynamic systems

System is said to be static or memory less if the output at any instant depends on only the input at that instant otherwise, the system is a dynamic system with memory.

5. Stable and unstable systems

A system is bounded input bounded output i.e. BIBO stable if for any bounded input x the corresponding output y is also bounded.

Note:

A consequence of the homogeneity of linear system is that a zero input yield a zero output.

Convolution

The convolution integral or the superposition integral, represent a continuous-time linear time invariant (LTI) system in terms of its response to a unit impulse.

Continuous-time LTI system

- Convolution of two functions, $x_1(t)$ and $x_2(t)$

$$y(t) = x_1(t) * x_2(t) = \int_{-\infty}^{\infty} x_1(\tau) x_2(t - \tau) d\tau$$

Note:

- If two analog signals get convolved:
 - (i) The resultant of convolution of two signals will have a width equal to the sum of the individual width of the two signals being convolved
 - (ii) Resultant of convolution has extent equal to the sum of the individual extents of the signals being convolved.

(iii) The area of resultant convolution is equal to the product of the area of the signals being convolved.

• If $f(t) * h(t) = y(t)$

then $f(\alpha t) * h(\alpha t) = \frac{1}{|\alpha|} y(\alpha t)$

Some important result for convolution

$$\int_{-\infty}^{\infty} x_1(\tau) x_2(t - \tau) d\tau = \int_{-\infty}^{\infty} x_2(\tau) x_1(t - \tau) d\tau$$

Special Cases

$$\phi(t) * \delta(t) = \int_{-\infty}^{\infty} \phi(\tau) \delta(t - \tau) d\tau = \phi(0)$$

$$\delta(t) * \delta(t) = \int_{-\infty}^{\infty} \delta(\tau) \delta(t - \tau) d\tau = \delta(t)$$

Properties of the convolution integral

- Commutative property

$$y(t) = x_1(t) * x_2(t) = x_2(t) * x_1(t)$$

- Distribution property

$$x_1(t) * [x_2(t) + x_3(t)] = x_1(t) * x_2(t) + x_1(t) * x_3(t)$$

- Associative property

$$x_1(t) * (x_2(t) * x_3(t)) = (x_1(t) * x_2(t)) * x_3(t)$$

- Derivative of the convolution

$$\frac{dy(t)}{dt} = \frac{dx_1(t)}{dt} * x_2(t) = x_1(t) * \frac{dx_2(t)}{dt}$$

- Convolution of two delayed functions

If $y(t) = x_1(t) * x_2(t)$

$$x_1(t - t_1) * x_2(t - t_2) = y(t - (t_1 + t_2))$$

- Time scaling property

if $y(t) = x_1(t) * x_2(t)$

$$x_1(\alpha t) * x_2(\alpha t) = \frac{1}{|\alpha|} y(\alpha t) ; \alpha \neq 0$$

Discrete-time LTI system

$$y[n] = \sum_{k=-\infty}^{\infty} x_1[k] x_2[n - k] = x_1[n] * x_2[n]$$

Note:

If two discrete signals get convolved:

- The resultant of convolution of two signals will have a length equal to the sum of the individual length of the two signals being convolved minus 1 i.e. $(L_1 + L_2 - 1)$.
- Resultant of convolution has extent equal to the sum of the individual extents of the signals being convolved.
- The sum of sampled values in resultant convolution is equal to the product of sum of the individual sampled values of the signals being convolved.



Fourier Series

Introduction

It is an approximated process by which a non-standard signal is converted into a standard signal. The approximation of a given function by Fourier series gives a smooth function even when the function being approximated has discontinuities.

Advantage

- We can find spectral width very easily.
- We can find steady state response very easily due to Periodic input.

Convergence of Fourier Series (Dirichlet Condition)

Periodic signal $x(t)$ has a Fourier series representation if it satisfies the following Dirichlet condition.

- $x(t)$ is absolutely integrable over any period i.e.

$$\int_{T_0} |x(t)| dt < \infty$$

- $x(t)$ has a finite number of maxima and minima within any finite interval of t .
- $x(t)$ has a finite number of discontinuities within any finite interval of t , and each of these discontinuities is finite.

Fourier Series Representation of Continuous Time

By using Fourier series, a non-sinusoidal periodic function can be expressed as an infinite sum of sinusoidal function.

1. Trigonometric Fourier series

Any practical periodic function of frequency ω_0 can be expressed as an infinite sum of sine (or) cosine functions that are integral multiples of ω_0

$$f(t) = a_0 + \sum_{n=1}^{\infty} (a_n \cos \omega_0 t + b_n \sin \omega_0 t)$$

- where,
- ω_0 = Fundamental frequency
 - a_0, a_n, b_n = Trigonometric Fourier series coefficient
 - $n\omega_0$ = n^{th} harmonic of ω_0

$$a_0 = \frac{1}{T} \int_0^T f(t) dt$$

$$a_n = \frac{2}{T} \int_0^T f(t) \cos n\omega_0 t dt$$

$$b_n = \frac{2}{T} \int_0^T f(t) \sin n\omega_0 t dt$$

Note:

- Here a_0 is the value of constant component of the signal $f(t)$
- The Fourier coefficient a_n and b_n are maximum amplitude of n^{th} harmonic component.

2. Polar form of trigonometric Fourier series

$$f(t) = C_0 + \sum_{n=1}^{\infty} C_n \cos(n\omega_0 t - \phi_n)$$

where,

$$C_0 = a_0$$

$$|C_n| = \sqrt{a_n^2 + b_n^2}$$

... Magnitude spectrum

$$\phi_n = \tan^{-1} \left(\frac{b_n}{a_n} \right)$$

... Phase spectrum

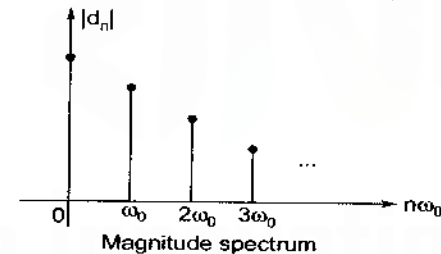

3. Exponential Fourier series

$$f(t) = \sum_{n=-\infty}^{\infty} C_n e^{jn\omega_0 t}$$

where,

$$C_0 = a_0 = \frac{1}{T} \int_0^T f(t) dt$$

$$C_n = \frac{1}{T} \int_0^T f(t) e^{-jn\omega_0 t} dt$$

Note:

Exponential Fourier series is compact form of Fourier series

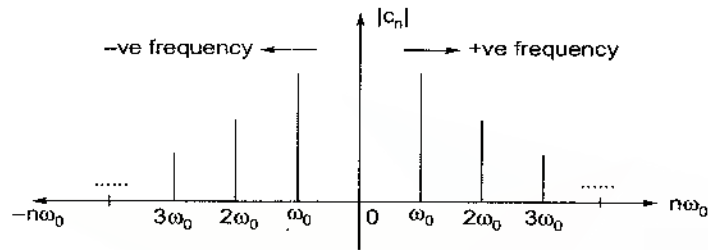

Positive and negative frequency indicate different phase of rotation, they maintain same magnitude but different phase.

Relation between exponential and trigonometric Fourier series

$$a_n = (C_n + C_{-n})$$

$$b_n = j(C_n - C_{-n})$$

Effect of Symmetry of Fourier Coefficients

1. Odd symmetry

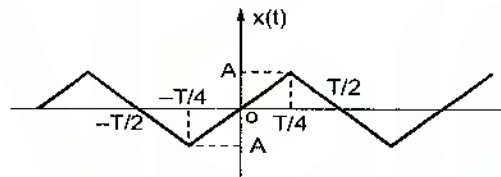

For signals with odd symmetry, the Fourier coefficient a_0 and a_n are zero.

$$x(t) = -x(-t)$$

2. Even symmetry

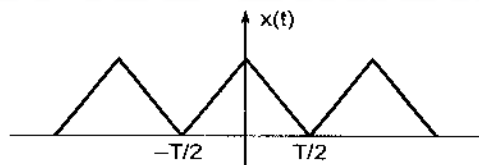

$$x(t) = x(-t)$$

For signals with even symmetry, the Fourier coefficient b_n are zero.

3. Half-wave symmetry

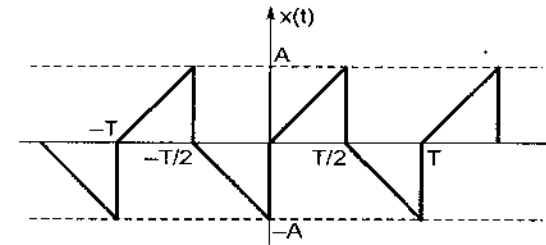

$$x(t \pm T/2) = -x(t)$$

For signals with half-wave symmetry, the Fourier series will consist of odd harmonic terms of sine and cosine signals.

Summary

Function	C_n	Fourier Coefficient	Trigonometric Fourier Series
Real (Neither even nor odd)	Generally Complex $C_n = C_n^*$	$a_0 \neq 0$ $a_n = b_n \neq 0$	DC term, sine terms and cosine terms are present.
Even	Real (Even in nature)	$a_0 \neq 0$ $a_n \neq 0$ $b_n = 0$	DC term and cosine terms are present.
Odd	Imaginary (odd in nature)	$a_0 = 0$ $a_n = 0$ $b_n \neq 0$	Only sine terms are present.
Half wave symmetry	$C_n = 0$; For $n = \text{even}$	$a_n = 0$; $b_n = 0$; $n = \text{even}$	Odd sine and odd cosine terms are present.
Even and Half wave symmetry	$C_n = \text{Real \& even}$ $C_n = 0$; $n = \text{even}$	$a_n = 0$; $b_n = 0$; $n = \text{even}$	Only odd cosine terms are present.
Odd and Half wave symmetry	$C_n = \text{Imaginary \& odd}$ $C_n = 0$; $n = \text{even}$	$a_n = 0$; $b_n = 0$; $n = \text{even}$	Only odd sine terms are present.

Parseval's Power Theorem

The average power P , if $x(t)$ has Fourier series coefficient C_n then Parseval's power theorem is given by

$$\frac{1}{T} \int_0^T |x(t)|^2 dt = \sum_{n=-\infty}^{\infty} |C_n|^2$$

Properties of Exponential Form of Fourier Series Coefficients

Property	Continuous Time Periodic Signal	Fourier Series Coefficients
Linearity	$A x(t) + B y(t)$	$AC_n + Bd_n$
Time shifting	$x(t \pm t_0)$	$C_n e^{\pm jn\omega_0 t_0}$
Frequency shifting	$e^{\pm jn\omega_0 t} x(t)$	$C_{n \pm m}$
Conjugation	$x^*(t)$	C_{-n}^*
Time reversal	$x(-t)$	C_{-n}
Time scaling	$x(\alpha t); \alpha > 0$ [x(t) is period with period T/α]	C_n (No change in Fourier coefficient)
Multiplication	$x(t) y(t)$	$\sum_{m=-\infty}^{\infty} C_m d_{n-m}$
Differentiation	$\frac{d}{dt} x(t)$	$jn\omega_0 C_n$
Integration	$\int_{-\infty}^t x(t) dt$ (Finite valued and periodic only if $a_0 = 0$)	$\frac{1}{jn\omega_0} C_n$
Periodic Convolution	$\int_T x(\tau) y(t - \tau) d\tau$	$TC_n d_n$
Symmetry of real signals	$x(t)$ is real	$C_n = C_{-n}^*$ $ C_n = C_{-n} ; \angle C_n = -\angle C_{-n}$ $\text{Re}\{C_n\} = \text{Re}\{C_{-n}\}$ $\text{Im}\{C_n\} = -\text{Im}\{C_{-n}\}$
Real and even	$x(t)$ real and even	C_n are real and even
Real and odd	$x(t)$ real and odd	C_n are imaginary and odd



Fourier Transform

4

Introduction

Fourier transform provides a frequency domain description of time domain signals and is extension of Fourier series to non-periodic signals.

- Fourier transform

$$F.T [f(t)] = F(\omega) = \int_{-\infty}^{\infty} f(t) e^{-j\omega t} dt$$

- Inverse Fourier transform

$$I.F.T [F(\omega)] = f(t) = \frac{1}{2\pi} \int_{-\infty}^{\infty} F(\omega) e^{j\omega t} d\omega$$

Dirichlets Conditions of Fourier Transformation

For existence of Fourier transform

- Fourier transform is defined for all stable signals

$$\int_{-\infty}^{\infty} |f(t)| dt < \infty$$

- Periodic signals, which are neither absolutely integrable nor square integral over an infinite interval, can be considered to have Fourier transform if impulse functions are permitted in the transform.
- $f(t)$ have a finite number of discontinuities and finite number of maxima and minima within any finite interval.

The Properties of Fourier Transform

Properties	X(f) - form	X(ω) - form
Linearity $ax_1(t) + bx_2(t)$	$aX_1(f) + bX_2(f)$	$aX_1(\omega) + bX_2(\omega)$
Time-scaling $x(at)$	$\frac{1}{ a } X\left(\frac{f}{a}\right)$	$\frac{1}{ a } X\left(\frac{\omega}{a}\right)$
Time-reversal $x(-t)$	$X(-f)$	$X(-\omega)$
Time-shift $x(t \pm t_0)$	$e^{\pm j2\pi f t_0} X(f)$	$e^{\pm j\omega t_0} X(\omega)$
Frequency shift $x(t)e^{\pm j\omega_0 t}$	$X(f \mp f_0)$	$X(\omega \mp \omega_0)$
Differentiation in time $\frac{d}{dt} x(t) \leftrightarrow j2\pi f X(f)$	$\frac{d}{dt} x(t) \leftrightarrow j\omega X(\omega)$	
Frequency Differentiation $-j2\pi f x(t) \leftrightarrow \frac{d}{df} X(f)$	$-j\omega x(t) \leftrightarrow \frac{d}{d\omega} X(\omega)$	
Convolution in time $x(t) * h(t)$	$X(f)H(f)$	$X(\omega)H(\omega)$
Frequency convolution $x_1(t) * x_2(t)$	$X_1(f) * X_2(f)$	$\frac{1}{2\pi} [X_1(\omega) * X_2(\omega)]$
Integration $\int_{-\infty}^t x(\tau) d\tau$	$\frac{X(f)}{j2\pi f} + 0.5X(0)\delta(f)$	$\frac{X(\omega)}{j\omega} + \pi X(0)\delta(\omega)$
Parseval's theorem $\int_{-\infty}^{+\infty} x^2(t) dt$	$\int_{-\infty}^{+\infty} X(f) ^2 df$	$\frac{1}{2\pi} \int_{-\infty}^{+\infty} X(\omega) ^2 d\omega$

Fourier Transform of Useful Signals

Signal, x(t)	F(f) form	F(ω) form
$e^{-at}u(t), a > 0$	$\frac{1}{a + j2\pi f}$	$\frac{1}{a + j\omega}$
$e^{at}u(-t), a > 0$	$\frac{1}{a - j2\pi f}$	$\frac{1}{a - j\omega}$
$\delta(t)$	1	1
A, Constant	$A\delta(f)$	$2\pi A\delta(\omega)$
A rect.(t/T)	$AT \text{sinc}(fT)$	$AT \text{sinc}\left(\frac{\omega T}{2}\right)$
$e^{-a t }$	$\frac{2a}{a^2 + 4\pi^2 f^2}$	$\frac{2a}{a^2 + \omega^2}$
e^{-at^2}	$\sqrt{\frac{\pi}{a}} e^{-\pi^2 f^2/a}$	$\sqrt{\frac{\pi}{a}} e^{-\omega^2/4a}$
Sgn(t)	$\frac{1}{j\pi f}$	$\frac{2}{j\omega}$
u(t)	$\frac{1}{j2\pi f} + 0.5\delta(f)$	$\frac{1}{j\omega} + \pi\delta(\omega)$
$\cos \omega_0 t$	$\frac{\delta(f - f_0) + \delta(f + f_0)}{2}$	$\pi [\delta(\omega - \omega_0) + \delta(\omega + \omega_0)]$
$\sin \omega_0 t$	$\frac{\delta(f - f_0) - \delta(f + f_0)}{2j}$	$\frac{\pi}{j} [\delta(\omega - \omega_0) - \delta(\omega + \omega_0)]$

■■■■

Laplace Transform



Introduction

The main drawback of (continuous) Fourier transform is that Fourier transform (F.T) can be defined only for stable systems. Where as Laplace transform (L.T) can be defined for both stable and unstable systems.

Laplace Transform

Laplace transform of a general signal $f(t)$

- Bilateral (or two) sided) Laplace transform

$$F(s) = \int_{-\infty}^{\infty} f(t)e^{-st} dt$$

- Unilateral (or one-sided) Laplace transform

$$F(s) = \int_0^{\infty} f(t)e^{-st} dt$$

Inverse Laplace Transform

$$f(t) = \int_{-\infty}^{\infty} F(s)e^{st} ds$$

Relation Between Laplace Transform and Fourier Transform

$$F(\sigma + j\omega) = \int_{-\infty}^{\infty} f(t)e^{-\sigma t} e^{-j\omega t} dt = e^{-\sigma t} F(\omega)$$

where, $s = \sigma + j\omega$

Note:

- At $\sigma = 0, s = j\omega$ then Laplace transform become equal to Fourier transform (or) L.T. calculated on $j\omega$ axis is F.T.
- Fourier transform used for signal analysis and Laplace transform used for designing of the system.

Region of Convergence (ROC)

The range of values of S for which $F(s)$ i.e. $\int_{-\infty}^{\infty} |f(t)e^{-\sigma t}| < \infty$ is define is known as ROC.

Properties of ROC

- ROC does not contain any poles, it is bounded by the poles.
- ROC of $F(s)$ contains of strips parallel to imaginary axis i.e. $j\omega$ axis.
- If $f(t)$ is of finite duration and is absolutely integrable than the ROC is entire S -plane.
- If $f(t)$ is a right sided and if the line $\text{Re}\{s\} = \sigma_0$ is in the ROC then all values of S for which $\text{Re}\{s\} > \sigma_0$ will also be in ROC.

Remember:

- For stability ROC must include imaginary axis (i.e. $j\omega$ axis)
- Solution of L.T. is unique only when the ROC is given

Properties of Laplace Transform

Linearity

$$f_1(t) \xrightarrow{\text{L.T.}} F_1(s) \text{ with ROC} = R_1$$

$$f_2(t) \xrightarrow{\text{L.T.}} F_2(s) \text{ with ROC} = R_2$$

$$af_1(t) + bf_2(t) \xrightarrow{\text{L.T.}} aF_1(s) + bF_2(s) ; \text{ROC} = R_1 \cap R_2$$

Time-shifting

$$f(t) \xrightarrow{\text{L.T.}} F(s) \text{ with ROC} = R$$

$$f(t \pm t_0) \xrightarrow{\text{L.T.}} e^{\pm st_0} F(s) ; \text{ROC} = R$$

Frequency shifting

$$f(t) \xrightarrow{\text{L.T.}} F(s) \text{ with ROC} = R$$

$$e^{s_0 t} f(t) \xrightarrow{\text{L.T.}} F(s - s_0) ; \text{ROC} = R + \text{Re}\{s_0\}$$

Time-reversal

$$f(t) \xrightarrow{\text{L.T.}} F(s)$$

$$f(-t) \xrightarrow{\text{L.T.}} F(-s); \text{ROC} = -R$$

Differentiation in S-domain

$$f(t) \xrightarrow{\text{L.T.}} F(s) \text{ ROC} = R$$

$$t f(t) \xrightarrow{\text{L.T.}} -\frac{d}{ds} F(s); \text{ROC} = R$$

Convolution in Time

$$\text{If } f(t) \xrightarrow{\text{L.T.}} F(s) \text{ with ROC} = R_1$$

$$\text{and } h(t) \xrightarrow{\text{L.T.}} H(s) \text{ with ROC} = R_2$$

$$f(t) * h(t) \xrightarrow{\text{L.T.}} F(s)H(s); \text{ROC} = R_1 \cap R_2$$

Note:

L.T. of impulse response is known as system or Transfer function

Frequency integration

$$\frac{f(t)}{t} \xrightarrow{\text{L.T.}} \int_s^{\infty} F(s) ds$$

Integration in time

$$\int_0^t f(\tau) d\tau \xrightarrow{\text{L.T.}} \frac{F(s)}{s}$$

Differentiation in time

$$\frac{d}{dt} f(t) \xrightarrow{\text{L.T.}} sF(s) - f(0)$$

$$\frac{d^2}{dt^2} f(t) \xrightarrow{\text{L.T.}} s^2 F(s) - sf(0) - f'(0)$$

Initial value theorem

$$f(0) = \lim_{s \rightarrow \infty} sF(s)$$

Final value theorem

$$f(\infty) = \lim_{s \rightarrow 0} sF(s)$$

Note:

- Initial value theorem is applicable only for proper Laplace i.e. denominator power of function is more than numerator power.
- Final value theorem is not applicable if poles are conjugate or poles lie in right side of s-plane.

Characterization of LTI Systems Using Laplace Transform**Causality**

- ROC associated with the system function for a causal system is a right-half plane.
- For a system with a rational system function, causality of the system is equivalent to the ROC being the right-half plane to the right of the rightmost pole.
- A system is anticausal if its impulse response $h(t) = 0$ for $t > 0$.

Stability

- An LTI system is stable if and only if the ROC of its system function $H(s)$ includes the $j\omega$ -axis, [i.e. $\text{Re}\{s\} = 0$].
- A causal system with rational system functions $H(s)$ is stable if and only if all of the poles of $H(s)$ lie in the left-half of the s-plane-i.e. all of the poles have negative real parts.

Laplace Transforms of Elementary Functions

Transform pair	Signal	Transform	ROC
1	$\delta(t)$	1	All s
2	$u(t)$	$\frac{1}{s}$	$\text{Re}\{s\} > 0$
3	$-u(-t)$	$\frac{1}{s}$	$\text{Re}\{s\} < 0$
4	$\frac{t^{n-1}}{(n-1)!} u(t)$	$\frac{1}{s^n}$	$\text{Re}\{s\} < 0$
5	$-\frac{t^{n-1}}{(n-1)!} u(-t)$	$\frac{1}{s^n}$	$\text{Re}\{s\} < 0$
6	$e^{-\alpha t} u(t)$	$\frac{1}{s + \alpha}$	$\text{Re}\{s\} > -\alpha$
7	$-e^{-\alpha t} u(-t)$	$\frac{1}{s + \alpha}$	$\text{Re}\{s\} < -\alpha$
8	$\frac{t^{n-1}}{(n-1)!} e^{-\alpha t} u(t)$	$\frac{1}{(s + \alpha)^n}$	$\text{Re}\{s\} > -\alpha$
9	$-\frac{t^{n-1}}{(n-1)!} e^{-\alpha t} u(-t)$	$\frac{1}{(s + \alpha)^n}$	$\text{Re}\{s\} < -\alpha$
10	$\delta(t - T)$	e^{-sT}	All s
11	$[\cos \omega_0 t] u(t)$	$\frac{s}{s^2 + \omega_0^2}$	$\text{Re}\{s\} > 0$
12	$[\sin \omega_0 t] u(t)$	$\frac{\omega_0}{s^2 + \omega_0^2}$	$\text{Re}\{s\} > 0$
13	$[e^{-\alpha t} \cos \omega_0 t] u(t)$	$\frac{s + \alpha}{(s + \alpha)^2 + \omega_0^2}$	$\text{Re}\{s\} > -\alpha$
14	$[e^{-\alpha t} \sin \omega_0 t] u(t)$	$\frac{\omega_0}{(s + \alpha)^2 + \omega_0^2}$	$\text{Re}\{s\} > -\alpha$
15	$u_n(t) = \frac{d^n \delta(t)}{dt^n}$	s^n	All s
16	$u_{-n}(t) = \underbrace{u(t) * \dots * u(t)}_{n \text{ times}}$	$\frac{1}{s^n}$	$\text{Re}\{s\} > 0$



Z-Transform

6

Introduction

- Z-transform is a discrete-time counterpart of Laplace transform.
- For a discrete-time LTI system with impulse response $h[n]$, the response $y[n]$ of the system to a complex exponential input of the form z^n is

$$y[n] = z^n H(z)$$

where, $H(z)$ = Transform function of the system

Z-transform

Z-transform of a general discrete time signal

$$X(z) = \sum_{n=-\infty}^{+\infty} x[n] z^{-n}$$

Note:

- The range of values of 'z' for which above equation is defined give ROC of Z-transform.
- Z-transform are used for digital filter design, sampled data control system.

Region of Convergence (ROC)

ROC is the region of range of values for which the summation

$$\sum_{n=-\infty}^{+\infty} x[n] z^{-n} \text{ converges.}$$

Properties of ROC

- The ROC of $X(z)$ consists of a circle in the z-plane centered about the origin.
- ROC does not contain any poles, it is bounded by the poles.
- If $x[n]$ is of finite duration then ROC is entire z-plane except possibly $z = 0$ and/or $z \rightarrow \infty$.
- If $x[n]$ is a right sided sequence and if circle $|z| = a$ is in the ROC then all finite values of z for which $|z| > a$ will also be in ROC.
- If $x[n]$ is a left sided sequence and if circle $|z| = a$ is the ROC then all finite values of z for which $|z| < a$ will also be in ROC.
- If $x[n]$ is two sided and if the circle $|z| = a$ is in the ROC, then the ROC will consist of a ring in the z-plane that includes the circle $|z| = a$.

Properties of Z-transform

Linearity

$$x_1[n] \xrightarrow{\text{Z.T.}} X_1(z), \text{ROC} = R_1$$

$$x_2[n] \xrightarrow{\text{Z.T.}} X_2(z), \text{ROC} = R_2$$

$$ax_1[n] + bx_2[n] \xrightarrow{\text{Z.T.}} aX_1(z) + bX_2(z); \text{ROC} = R_1 \cap R_2$$

Time shift

$$x[n] \xrightarrow{\text{Z.T.}} X(z), \text{ROC} = R$$

$$x[n - n_0] \xrightarrow{\text{Z.T.}} z^{-n_0} X(z); \text{ROC} = R$$

Exponential multiplication or scaling in z-domain

$$x[n] \xrightarrow{\text{Z.T.}} X(z) \text{ with } \text{ROC} = R$$

$$a^n x[n] \xrightarrow{\text{Z.T.}} X(z/a); \text{ROC} = |a|R$$

Time reversal

$$x[n] \xrightarrow{\text{Z.T.}} X(z), \text{ then}$$

$$x[-n] \xrightarrow{\text{Z.T.}} X(z^{-1}); \text{ROC} = 1/R$$

Differential in z-domain

$$nx[n] \xrightarrow{\text{Z.T.}} -z \frac{d}{dz} X(z); \text{ROC} = R$$

Convolution in Time

$$x[n] \xrightarrow{\text{Z.T.}} X(z) \text{ with } \text{ROC} = R_1$$

$$h[n] \xrightarrow{\text{Z.T.}} H(z) \text{ with } \text{ROC} = R_2$$

$$x[n] * h[n] \xrightarrow{\text{Z.T.}} X(z)H(z); \text{ROC} = R_1 \cap R_2$$

Accumulation

$$x[n] \xrightarrow{\text{Z.T.}} X(z), \text{ROC} = R$$

$$\sum_{k=-\infty}^n x[k] \xrightarrow{\text{Z.T.}} \frac{X(z)}{1-z^{-1}}; \text{ROC} = R \cap |z| > 1$$

Unilateral Z-transform

$$x[z] \xrightarrow{\text{u.Z.T.}} \sum_{n=0}^{\infty} x[n]z^{-n}$$

Left shift

$$x[n+1] \xrightarrow{\text{Z.T.}} Z \times (z) - Z \times (0)$$

Right shift

$$x[n-1] \xrightarrow{\text{Z.T.}} Z^{-1} \times (z) + x(-1)$$

$$x[n-2] \xrightarrow{\text{Z.T.}} Z^{-2} \times (z) + x(-1) + x(-2)$$

First difference

$$x[n] - x[n-1] = (1 - Z^{-1}) \times (z)$$

Conjugation

$$x^*[n] = x^*(z^*)$$

Initial value theorem

If $x[n] = 0$ for $n < 0$

$$x[0] = \lim_{Z \rightarrow \infty} x(z)$$

Final value theorem

$$x[\infty] = \lim_{Z \rightarrow 1} (1 - z^{-1}) \times (z) \quad \text{or} \quad x[\infty] = \lim_{Z \rightarrow 1} (z - 1) \times (z)$$

Characterization of LTI Systems Using Z-Transform

Causality

- A discrete-time LTI system is causal if and only if the ROC of its system function is the exterior of a circle, including infinity.
- A discrete-time LTI system with rational system function $H(z)$ is causal if and only if:
 - the ROC is the exterior of a circle outside the outermost pole; and
 - with $H(z)$ expressed as a ratio of polynomials in z , the order of the numerator cannot be greater than the order of the denominator.

Stability

- An LTI system is stable if and only if the ROC of its system function $H(z)$ includes the unit circle, $|z| = 1$.

- A causal LTI system with rational system function $H(z)$ is stable if and only if all of the poles of $H(z)$ lie inside the unit circle i.e., they must all have magnitude smaller than 1.

Inverse Z-transform

$$x[n] = \frac{1}{2\pi j} \oint X(z) z^{n-1} dz$$

- Where the symbol \oint denotes integration around a counter clockwise circular contour centred at the origin with radius a .

Some Common Z - transform Pairs

Signal	Transform	ROC
1. $\delta[n]$	1	All z
2. $u[n]$	$\frac{1}{1-z^{-1}}$	$ z > 1$
3. $-u[-n-1]$	$\frac{1}{1-z^{-1}}$	$ z < 1$
4. $\delta[n-m]$	z^{-m}	All z , except 0 (if $m > 0$) or ∞ (if $m < 0$)
5. $\alpha^n u[n]$	$\frac{1}{1-\alpha z^{-1}}$	$ z > \alpha $
6. $-\alpha^n u[-n-1]$	$\frac{1}{1-\alpha z^{-1}}$	$ z < \alpha $
7. $n\alpha^n u[n]$	$\frac{\alpha z^{-1}}{(1-\alpha z^{-1})^2}$	$ z > \alpha $
8. $-n\alpha^n u[-n-1]$	$\frac{\alpha z^{-1}}{(1-\alpha z^{-1})^2}$	$ z < \alpha $
9. $[\cos\omega_0 n]u[n]$	$\frac{1 - [\cos\omega_0]z^{-1}}{1 - [2\cos\omega_0]z^{-1} + z^{-2}}$	$ z > 1$
10. $[\sin\omega_0 n]u[n]$	$\frac{[\sin\omega_0]z^{-1}}{1 - [2\cos\omega_0]z^{-1} + z^{-2}}$	$ z > 1$
11. $[a^n \cos\omega_0 n]u[n]$	$\frac{1 - [a\cos\omega_0]z^{-1}}{1 - [2a\cos\omega_0]z^{-1} + a^2 z^{-2}}$	$ z > a$
12. $[a^n \sin\omega_0 n]u[n]$	$\frac{[a\sin\omega_0]z^{-1}}{1 - [2a\cos\omega_0]z^{-1} + a^2 z^{-2}}$	$ z > a$

Basic Realization Structure		
Element	Time domain representation	Z-domain representation
1. Adder		
2. Multiplier		
3. Delay element		
4. Unit advance element		



A Handbook on Electrical Engineering

8

Analog Electronics

CONTENTS

1. Semiconductor Physics	419
2. Junction Diode Characteristics	430
3. Bipolar Junction Transistors	440
4. Transistor Biasing Circuits	446
5. BJT as an Amplifier	450
6. Junction Field Effect Transistors	453
7. Metal Oxide Semiconductor Field Effect Transistor	459
8. Transistor Hybrid Model	462
9. Feedback Amplifiers	465
10. Operational Amplifiers	470
11. Large Signal Amplifiers	477
12. The Signal Generators and Wave Shaping Circuits	483



semiconductor Physics

1

Energy Band

1. **Valence band:** The band occupied by the valence electrons or a band having highest occupied band energy is called valence band.
2. **Conduction band:** The band occupied by the conduction electrons or the band having the lowest unfilled energy is called conduction band.
3. **Forbidden energy gap:** The separation between conduction band and valence band is known as forbidden energy gap.

Remember:

- Valence band can never be empty.
- When a substance has empty conduction band the current conduction is not possible.
- In order to push an electron from valence band to conduction band, external energy is required which is equal to the forbidden energy gap.

Energy Band Diagram

Where,

- E_V is highest energy for the electron when it is inside the atom. It is the minimum energy to be given externally to make that electron free from atom.
- E_C is the lowest energy of the electron participating in the current conduction.
- $E_g = E_C - E_V$, is the amount of energy require to break the covalent bond and make the electron participate in the current conduction.

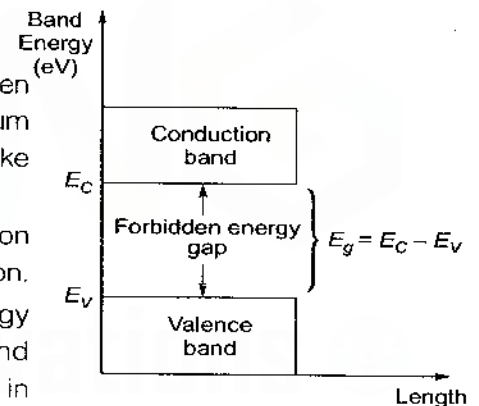

Note:

- Electron volt (eV) is smallest unit of energy.
- 1 eV is defined as the amount of energy accepted or released by a single electron when it is moving in the potential difference of 1 V.

$$1 \text{ eV} = 1.6 \times 10^{-19} \text{ Joule}$$

- With increase in the temperature energy gap decreases as

$$(E_g)_{T^\circ K} = (E_g)_{0^\circ K} - \beta T$$

where, β = Weiss constant
 = 2.36×10^{-4} for Ge
 = 3.6×10^{-4} for Si

	Ge	Si	GaAs
$(E_g)_{0^\circ K}$	0.782 eV	1.21 eV	1.56 eV
$(E_g)_{300^\circ K}$	0.72 eV	1.12 eV	1.43 eV

Insulators, Conductors and Semiconductors

Insulator

In insulators, the forbidden energy band is very wide, thus electrons cannot jump from valence band to conduction band. The resistivity of insulators is of the order of 10^7 ohm-metre.

Conductor

In conductors, there is no forbidden band and the valence band and the conduction band overlap each other. The total current in conductor is simply due to the flow of electrons.

Semiconductor

In semiconductor, the forbidden band is very small. A semiconductor material is one whose electrical properties lies between insulators and good conductors. In semiconductors, the conductivities are of the order of 10^2 mho/metre.

Note:

In germanium the forbidden band is of the order of 0.7 eV while in case of silicon, the forbidden band is of the order of 1.1 eV.

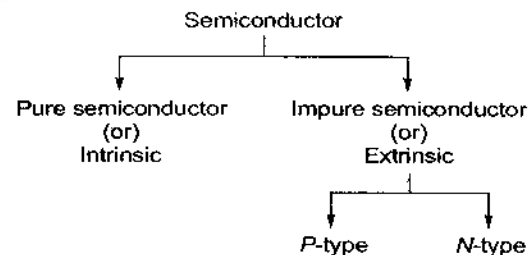

Intrinsic semiconductor

A semiconductor in an extremely pure form is known as intrinsic semiconductor. In this type of semiconductor electrons and holes are solely created by thermal excitation.

Extrinsic semiconductor

In extrinsic semiconductor, a small percentage of trivalent or pentavalent atoms impurity are added to the pure semiconductor. The process of adding impurities to pure semiconductor is called doping.

P-type extrinsic semiconductor

When a small amount of trivalent impurity is added to a pure crystal during the crystal growth, the resulting crystal is called P-type extrinsic semiconductor. Example of trivalent impurity is Boron, Gallium or Indium.

Note:

In P-type semiconductor materials, the majority carriers are holes while the minority carriers are electrons.

N-type extrinsic semiconductor

When a small amount of pentavalent impurity (Antimony, Phosphorous or Arsenic) is added to a pure semiconductor crystal during the crystal growth, the resulting crystal is called as N-type extrinsic semiconductor.

Note:

In N-type semiconductor, the electrons are the majority carriers while holes are minority carriers.

Mass Action Law

It states that at thermal equilibrium the product of concentration of free electrons and holes is equal to the square of intrinsic concentration at that temperature i.e.

$$n_o p_o = n_i^2$$

where, n_o = Concentration of electron in conduction band
 p_o = Concentration of holes in valence band
 n_i = Intrinsic concentration at given temperature

Intrinsic concentration

$$n_i^2 = A_0 T^3 e^{-E_g/kT}$$

where, $A_0 =$ is a constant

Note:

Intrinsic concentration depends on temperature. As temperature increases the intrinsic concentration increases as $T^{3/2}$.

Mobility

- It is drift velocity per unit electric field.
- It defines how fast the charge travels from one place to other and is given by

$$\mu = \frac{v_d}{E}$$

where, $v_d =$ drift velocity ; $E =$ electric field

Note:

Electron's mobility is always greater than hole mobility in a given material. Hence electron can travel faster so contribute more current for same electric field than hole as explained by quantum mechanical physics.

- Mobility of charge carriers decreases with temperature and varies as

$$\mu \propto T^{-m}$$

where, m is a constant

$m = 1.66$ for e^- and 2.33 for hole for Ge

$m = 2.5$ for e^- and 2.7 for hole for Si

- Mobility also varies with electric field applied as

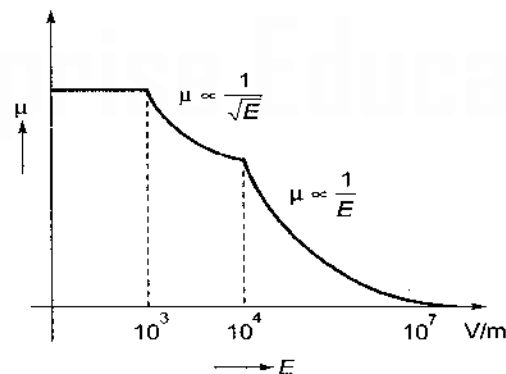
**Note:**

- At smaller electric field mobility is constant.
- At very high electric field product of mobility and electric field becomes constant and is equal to saturation value of drift velocity.

Remember:

$\text{cm}^2/\text{V-sec}$	Ge	Si	GaAs
μ_n	3800	1300	4600
μ_p	1800	500	300

At $T = 300^\circ\text{K}$

Drift current and conductivity

Drift current I_D is defined as the charge flowing per second across any normal plane of the conductor.

$$I_D = nAqv_d = nAq\mu E$$

Drift current density (J)

$$J = \frac{I_D}{A} = nq\mu E$$

But $J = \sigma E$... According to Ohm's law

So, $\sigma = nq\mu$

or, $\sigma = qn\mu_n + qp\mu_p$

In intrinsic semiconductor

$$n = p = n_i$$

$$\sigma_{\text{total}} = \sigma_n + \sigma_p$$

$$\sigma = n_i q (\mu_n + \mu_p)$$

Conductivity of extrinsic semiconductor**1. For n-type**

$$\sigma \cong qN_D\mu_n$$

where, $N_D =$ Donor concentration

2. For p-type

$$\sigma \cong qN_A\mu_p$$

where, $N_A =$ Acceptor concentration

Remember:

- Conductivity of pure semiconductor increases with temperature.
- Conductivity of pure semiconductor at 0°K is zero.
- Conductivity of extrinsic semiconductor decrease with increase in temperature above normal temperature.
- Conductivity of extrinsic semiconductor initially increases when temperature rises from 0°K.
- Conductivity increases with increase in doping temperature.
- Conductivity of extrinsic semiconductor at 0°K is zero.
- At Curie temperature conductivity becomes equal to intrinsic conductivity.

Concentration of Charge Carriers**1. Number of electrons in the conduction band**

$$n_o = N_C e^{-(E_C - E_F)/kT}$$

- where,
- E_F = Fermi energy level
 - E_C = Energy level of lowest
 - k = Boltzman's constant
 - T = Absolute temperature
 - N_C = Effective density of states in conduction band

$$N_C = 2 \left[\frac{2\pi m_e kT}{h^2} \right]^{3/2}$$

- where,
- m_e = Mass of electron = 9.1×10^{-31} kg
 - h = Plank's constant = 6.636×10^{-31} J-s

Number of holes in the valence band

$$p_o = N_V e^{-(E_F - E_V)/kT}$$

- where,
- N_V = Effective density of states in valence band
 - E_V = Highest energy level of valence band

$$N_V = 2 \left[\frac{2\pi m_h kT}{h^2} \right]^{3/2}$$

- where,
- m_h = Mass of hole = 9.1×10^{-31} kg

Fermi Level

- Fermi level is energy state having probability 1/2 of being occupied of an electron if there is no forbidden band exists.
- Energy of fastest moving electron at 0 K is called fermi energy level.
- **Fermi dirac function** $f(E)$ gives the probability that an available energy state E will be occupied by an electron at absolute temperature T , under conditions of thermal equilibrium.

Fermi-Dirac function

$$f(E) = \frac{1}{1 + e^{(E - E_F)/kT}}$$

- where,
- E_F = Energy of Fermi level in eV.

Fermi Level in Intrinsic Semiconductor

$$E_F = \frac{E_C + E_V}{2} - \frac{kT}{2} \ln \frac{N_C}{N_V}$$

- where,
- E_C = Maximum energy of conduction band
 - E_V = Maximum energy of valence band
- For $m_e = m_h$ at $T = 0$

$$E_F = \frac{E_C + E_V}{2}$$

- In intrinsic semiconductor Fermi level stays at the centre of energy gap. Such that Fermi level is independent of temperature.
- In intrinsic semiconductor the probability of occupancy of charge carrier is 50%.

Fermi level in N-type extrinsic semiconductor

$$E_F = E_C - kT \log_e \left(\frac{N_C}{N_D} \right)$$

- where,
- N_D = Concentration of donor ion
 - N_C = Material constant and can be considered as a function of temperature

Note:

- In *N*-type semiconductor Fermi-level depends on both temperature and donor concentration.
- At 0°K Fermi level coincides with E_C .
- As temperature increases Fermi-level moves towards the middle of band gap.
- As donor concentration increases Fermi level moves towards the E_C .
- Normally Fermi level lies close to E_C .

Fermi level in *p*-type extrinsic semiconductor

$$E_F = E_V + kT \log_e \left(\frac{N_V}{N_A} \right)$$

where, N_V = Density of states in valence band
 N_A = Concentration of acceptors.

Note:

- In *p*-type semiconductor Fermi level E_F at 0°K coincides with E_V .
- In *p*-type semiconductor Fermi level lies close to valence band.
- In *p*-type semiconductor Fermi level moves away from valence band as temperature increases.
- In *p*-type semiconductor fermi level moves towards valence band as N_A increases.

Diffusion and Diffusion Current

- The migration of charge carrier from higher concentration to lower concentration or from higher density to lower density is called diffusion. The current due to this diffusion process is called diffusion current.
- Diffusion current flows only in semiconductor.
- Diffusion is associated with random motion of charge carriers due to thermal vibrations.

Diffusion current density due to electrons and holes

$$J_n = qD_n \left(\frac{dn}{dx} \right) \quad ; \quad J_p = -qD_p \left(\frac{dp}{dx} \right)$$

where, D_n = Electron diffusion coefficient

D_p = Hole diffusion coefficient

$\frac{dn}{dx}$ = Electron concentration gradient

$\frac{dp}{dx}$ = Hole concentration gradient

Length of diffusion

Average distance travelled by charge carriers before recombination.

$$L = \sqrt{D\tau}$$

where, L = Diffusion length
 D = Diffusion constant of charge carrier
 τ = Carrier life time

We know, $D = \mu V_T$ and $V_T = \frac{kT}{q}$

So, $L = \sqrt{\mu V_T \tau}$

where, μ = Mobility of charge
 V_T = Thermal voltage

(a) Diffusion length of electron

$$L_n = \sqrt{D_n \tau_n}$$

(b) Diffusion length of hole

$$L_p = \sqrt{D_p \tau_p}$$

Remember:

Diffusion length depends upon:

- Diffusion constant (D)
- Carrier life time (τ)
- Temperature (T)
- Mobility of charge carrier (μ)

Einstein Relation

This gives the relation between diffusion constant D and mobility μ .

$$\frac{D_n}{\mu_n} = \frac{D_p}{\mu_p} = V_T$$

where, V_T = Volt equivalent of temperature

$$V_T = \frac{kT}{q} = \frac{T}{11600}$$

where, k = Boltzman constant

Note:

At room temperature i.e. 300°K, $V_T = 26$ mV.

Overall Current Density

The conduction of current in semiconductor materials may occur due to

- (i) Drift of charged particles under the effect of applied electric field.
- (ii) Diffusion of carriers from a region of high charge density to region of lower charge density.

and it is possible that a potential gradient and a concentration gradient may exist within a semiconductor.

(a) Total hole current density

$$J_p = q\mu_p E_p - qD_p \frac{dp}{dx}$$

(b) Total electron current density

$$J_e = q\mu_n E_n - qD_n \frac{dn}{dx}$$

Continuity equation

$$\frac{\partial \delta p}{\partial t} = \frac{1}{q} \frac{\partial J_p}{\partial x} - \frac{\delta p}{\tau_p}$$

$$\frac{\partial \delta n}{\partial t} = \frac{1}{q} \frac{\partial J_n}{\partial x} - \frac{\delta n}{\tau_n}$$

where, $\delta p, \delta n$ = Excess carrier concentration

τ_n, τ_p = Carrier life time for electron and holes respectively

Another form of this equation is

$$\frac{\partial \delta n}{\partial t} = D_n \frac{\partial^2 \delta n}{\partial x^2} - \frac{\delta n}{\tau_n}$$

$$\frac{\partial \delta p}{\partial t} = D_p \frac{\partial^2 \delta p}{\partial x^2} - \frac{\delta p}{\tau_p}$$

Remember:

- Conductors are PTC of resistivity whereas semiconductors are NTC of resistivity.
- Highly doped semiconductors exhibits metallic property.
- For intrinsic semiconductors
Carrier concentration \propto Temperature
Conductivity \propto (Temp.)^{3/2} and
Conductivity \propto Doping.
- For extrinsic semiconductors.
Majority carrier concentration \propto doping
Minority carrier concentration \propto 1/Doping
Minority carrier concentration \propto Temperature
Majority carrier concentration is almost independent of temperature.



Junction Diode Characteristics

2

Junction Diode

- A diode is the second generation semiconductor family.
- It is a single layer, two region, single junction, two terminal unilateral active semiconductor device.
- A *p-n* junction is formed from a piece of semiconductor by diffusing *p*-type material to one half side and *n*-type material to other half side.
- The plane dividing the two zones is known as a junction.
- A region near the junction is without any free charge particles called depletion region or charged free region or space charge region because there is no charge available for conduction.

Note:

- Depletion layer consists of immobile charged particles i.e. ions only.
- Depletion layer consists of negative ion (Acceptor ions) on the *p*-side and positive ion (Donor ions) on the *n*-side.
- Depletion layer opposes majority carriers in crossing the junction.

Contact Potential or Build in Potential (V_o)

$$V_o = \frac{kT}{q} \ln \left[\frac{N_A N_D}{n_i^2} \right]$$

- where, V_o = Contact potential
 k = Boltzman's constant (1.38×10^{-23} J/K)
 q = Electron charge (1.6×10^{-19} Coulomb)
 T = Temperature in Kelvin
 N_A = Concentration of accepters on *p*-side
 N_D = Concentration of donor on *n*-side
 n_i = Intrinsic concentration at given temperature

Note:

- In case of Ge diode typical value of V_o is 0.2 Volt and for Si diode it is 0.7 V.
- In unbiased *p-n* junction diode electric field is maximum at the junction and decreases on either side of junction and zero outside of the depletion layer.

Contact potential in the terms of maximum electric field

$$V_o = -\frac{1}{2} E_o w$$

- where, E_o = Maximum electric field at junction
 w = Width of depletion region

Remember:

Depletion width increases with reverse and decrease with forward biased.

Depletion Width (w)

- Width of depletion region in unbiased condition is given by

$$w = \left[\frac{2 \epsilon V_o}{q} \left(\frac{1}{N_a} + \frac{1}{N_d} \right) \right]^{1/2}$$

- where, ϵ = permitivity of material used for formation *p-n* junction diode
 V_o = contact potential
 q = electron charge (1.6×10^{-19} Coulomb)
 N_a = concentration of acceptors (/cm³) on *p*-side
 N_d = concentration of donors (/cm³) on *n*-side

Note:

- If we reverse bias the diode by voltage V then in formulae of depletion width V_o is replaced by $|V_o + V|$.
- It is clear that depletion width increases with reserve and decreases with forward biased.

$$w \propto \frac{1}{\sqrt{\text{concentration}}}$$

Current Equation of Diode

Boltzman's equation of diode current

$$I = I_o \left[\exp \left(\frac{V}{\eta V_T} \right) - 1 \right]$$

- where, I = Diode current
 I_o = Diode reverse current
 V = Diode voltage (Positive for forward bias and negative for reverse bias)

$\eta = 1$ for germanium and 2 for silicon

$V_T =$ Thermal voltage

$T =$ Temperature in Kelvin

In forward bias

$$I_F = I_o \exp\left(\frac{V_F}{\eta V_T}\right)$$

In reverse bias

$$I_R \equiv -I_o$$

Note:

Reverse current I_o is temperature dependent. It gets double for every 10°C rise.

Resistance of Diode

Resistance of diode can be calculated only when the diode is in forward bias.

(a) **Static resistance (DC resistance):** It is ratio of voltage and current at any point.

$$R_{DC} = \frac{V}{I}$$

(b) **Dynamic resistance (AC resistance):** It is define as reciprocal of slope, which is the smallest linear region in the entire non-linear curve.

$$R_{AC} = \frac{1}{\text{Slope}} \quad ; \quad R_{AC} = \frac{dV}{dI}$$

$$R_{AC} = \frac{\eta V_T}{I_F} = \frac{\eta kT}{I_F q}$$

Note:

Static resistance is always greater than AC or dynamic resistance.

Capacitance of Diode

1. Diffusion capacitance or storage capacitance

When a diode is forward biased, a capacitance called diffusion capacitance or storage capacitance (C_D) is formed due to junction.

$$C_D = \frac{qF}{\eta V_T} = \frac{\tau I_F}{\eta V_T}$$

where,

$C_D =$ Diffusion capacitance

$\tau =$ Mean life time of minority carriers on either side or time constant of diode

$\eta =$ Recombination of factor, 1 for Ge, 2 for Si

$V_T =$ Thermal voltage

$I_F =$ Forward current

Note:

Diffusion capacitance is proportional to the forward current and forward current depends on forward voltage.

$$C_D \propto \sqrt{\text{Doping}}$$

2. Transition capacitance or space charge capacitance

It is also known as depletion capacitance. It is the capacitance when diode is in reverse bias.

$$C_T = \frac{\epsilon_o \epsilon_r A}{\omega_d}$$

where,

$C_T =$ Transition capacitance

$\omega_d =$ Width of depletion layer

Also

$\omega_d \propto V_r$ (Reverse bias voltage)

So,

$$C_T \propto \frac{1}{V_r^n}$$

where,

$n = \frac{1}{2} =$ Step graded

$= \frac{1}{3} =$ Linearly graded

The transition capacitance depends upon the magnitude of the reverse voltage applied.

Note:

- Transition capacitance can be used as variable capacitance for tuning the frequencies of television and radio channel.
- Maximum value of C_T is 40 pF.

- Maximum value of C_D is 0.02 μF .
- Diffusion capacitance is always greater than transition capacitance i.e. $C_D > C_T$.

Zener Diode

- It is a heavily-doped $p-n$ junction diode which is operated under reverse bias condition in the breakdown region.
- Zener current is independent of the supply voltage and only depends on external circuit resistance. Therefore Zener diode is known as constant voltage or voltage reference device.
- At reverse voltages less than 6 V, Zener breakdown predominates while at about 8 V, Avalanche breakdown predominates.
- Zener breakdown diodes are negative temperature coefficient of voltage and Avalanche breakdown diodes are positive temperature coefficient of voltage.
- These are used for voltage regulators.

Schottky Diode

- It is a metal-semiconductor junction diode without depletion layer.
- In Schottky diode no depletion layer is formed and there will be no holes in this diode.
- Cut-in voltage of this diode is 0.3 V.
- This diode is used at high frequencies.

Photo Diode

- Principle of operation is *photo conductive effect*.
- Photo sensitive material used are CdS, Se, ZnS.
- It is also called *light operated switch*.
- Ge-photo diode respond to visible light while Si-photo diode respond to infrared light.
- Photo sensitive coating is provided at junction only.
- Compare to normal diode photo diode has larger depletion width obtained from lower level of doping.
- It is always operated under *reverse biased condition*.
- Compare to normal diode it is 10 times faster, 100 times higher sensitive but power handling capacity is low.

- Magnitude of photo current increases with increase in intensity of light falling at junction.
- Current in photo diode is given by

$$I = I_s + I_0 [1 - e^{V/\eta V_T}]$$

where, I_s = short circuit current of photo diode
 I_0 = reverse saturation current
 V = voltage applied
 V_T = thermal voltage

- Photo current flows from n to p.
- Photo current is a minority carrier current.
- It does not provide gain.
- Photo current is a *diffusion current*.
- It is used in remote control sensor, in designing of optocouplers and to read audio track recorded on motion picture film.
- When photo diode is forward biased it behaves as a normal diode and effect of light on current is zero.

Tunnel Diode

- It is fastest switch.
- Its response time is of the order of peco second.
- It is a $p^+ n^+$ diode having doping level of 1 : 10^3 .
- Worked on the principle of *tunneling effect*.
- It has very narrow depletion layer 100 Å to 200 Å.
- It is used as linear device as well as negative resistance device.
- Best material is GaAs having highest swing.
- It is used in designing microwave oscillators, as a relaxation oscillator, in designing of pulse and switching circuits, and as parametric amplifier.

Rectifiers

Ripple factor (γ)

The amount of AC present in the output of rectifier is called as ripple. The amount of AC, from the signal contains AC and DC is calculated by ripple factor.

$$\gamma = \frac{\text{rms value of AC component}}{\text{DC value}}$$

$$\gamma = \sqrt{\left(\frac{V_{\text{rms}}}{V_{\text{DC}}}\right)^2 - 1}$$

Form factor (F)

$$F = \frac{\text{rms value}}{\text{DC value}} = \frac{V_{\text{rms}}}{V_{\text{DC}}} \quad ; \quad \gamma = \sqrt{F^2 - 1}$$

Crest factor (C)

$$C = \frac{\text{Peak value}}{\text{rms value}}$$

Efficiency (η)

$$\eta = \frac{\text{Output DC power}}{\text{AC input power}}$$

Half Wave Rectifier**Average value of current and voltage****(a) Ideal case**

$$I_{\text{DC}} = \frac{I_m}{\pi} \quad \text{and} \quad I_m = \frac{V_m}{R_L}$$

$$V_{\text{DC}} = \frac{V_m}{\pi}$$

where,

 I_{DC} = Average value of current V_{DC} = Average value of voltage I_m = Maximum value of current V_m = Maximum value of voltage R_L = Load resistance**(b) Practical case**

$$I_{\text{DC}} = \frac{I'_m}{\pi} \quad ; \quad V_{\text{DC}} = \frac{V'_m}{\pi}$$

$$I'_m = \frac{V_m}{R_s + R_f + R_L} \quad ; \quad V'_m = I'_m R_L$$

where,

 R_s = Coil resistance R_f = Diode forward resistance R_L = Load resistance**RMS value of current and voltage**

$$I_{\text{rms}} = \frac{I_m}{2}$$

$$V_{\text{rms}} = \frac{V_m}{2}$$

Efficiency of half-wave rectifier

$$\eta = \frac{I_{\text{DC}}^2 R_L}{I_{\text{rms}}^2 [R_s + R_f + R_L]} = \frac{4}{\pi^2} \left[\frac{R_L}{R_s + R_f + R_L} \right]$$

• Ripple factor of half wave rectifier

$$\gamma = 1.21$$

• Crest factor of half-wave rectifier

$$C = 2$$

• Form factor of half-wave rectifier

$$F = 1.58$$

Remember:

- Maximum efficiency (when $R_s = R_f = 0$) ideal case

$$\eta = \frac{4}{\pi^2} = 40.6\%$$

- Peak inverse voltage for half wave rectifier $\text{PIV} = V_m$.
- Transformer utilization factor (TUF) for half wave rectifier $\text{TUF} = 0.286$.
- Output frequency = Input frequency for half wave rectifier.
- Conduction angle for half wave rectifier: $\theta = \pi$ for ideal case

$$\theta = \pi - 2 \sin^{-1} \frac{V_y}{V_m} \quad \text{for practical case}$$

 V_y = cut-in voltage of diode ; V_m = maximum voltage

- Ripple frequency (f_r) for half wave rectifier

$$f_r = f \quad ; \quad f = \text{input frequency}$$

Full Wave Centre Tap Rectifier

Average value of current and voltage

$$I_{DC} = \frac{2I_m}{\pi}, \text{ ideal case}$$

$$V_{dc} = \frac{2V_m}{\pi}, \text{ ideal case}$$

RMS value of current and voltage

$$I_{rms} = \frac{I_m}{\sqrt{2}}, \text{ ideal case}$$

$$V_{rms} = \frac{V_m}{\sqrt{2}}, \text{ ideal case}$$

For practical case I_m is replaced by I'_m .

where,
$$I'_m = \frac{V_m}{\frac{R_s}{2} + R_f + R_L} \text{ and } V'_m = I'_m R_L$$

Efficiency

$$\eta = \frac{8}{\pi^2} \frac{R_L}{\frac{R_s}{2} + R_f + R_L}$$

- Ripple factor (γ) = 0.48 for full wave rectifier.
- Form factor (F) = 1.11 for full wave rectifier.
- Crest factor (C) = $\sqrt{2}$ for full wave rectifier.

Remember:

- η is maximum when $R_s = R_f = 0 \rightarrow$ ideal case and $\eta_{max} = \frac{8}{\pi^2} = 81.2\%$
- Peak inverse voltage for full wave rectifier (centre tap) is $PIV = 2V_m$
- Transformer utilization factor (TUF): TUF = 0.693 for full wave centre tap.

Full Wave Bridge Rectifier

For full wave rectifier (bridge type) in all the formulas $\frac{R_s}{2}$ is replaced by R_s and R_f is replaced by $2R_f$.

Remember:

- For bridge type $PIV = V_m$
- TUF = 0.812 for bridge type.
- Conduction angle: $\theta = 2\pi$ ideal case

$$\theta = 2\pi - 4 \sin^{-1} \frac{V_f}{V_m}$$

for center tap

$$\theta = 2\pi - 4 \sin^{-1} \frac{2V_f}{V_m}$$

$V_f \rightarrow$ cut in voltage of diode

Remaining parameters are same as full wave centre tap rectifier.



Bipolar Junction Transistors



- A transistor is 3 layer, 3 terminal, 2 junction semiconductor device.
- It consist of either two *n*-type and one *p*-type layers of material called *npn* transistor or two *p*-type and one *n*-type material called *pnp* transistor.
- In transistor current flows due to both majority as well as minority carrier that's why called a bipolar device.
- It is a current controlled device.
- Its input impedance is low and output impedance is high.
- Thermal stability is lesser because of leakage current or reverse saturation current.
- In transistor all the major currents are diffusion currents.
- Base current is recombination current.
- A transistor represented by two diode connected back to back cannot work as transistor as there is no bonding between base and collector.
- Current conduction in *pnp* transistor is carried out by hole whereas in *npn* transistor it is due to electrons.

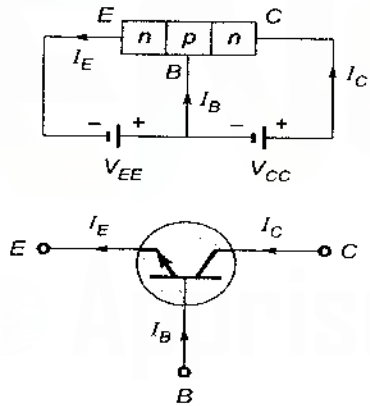

(a) *npn* transistor

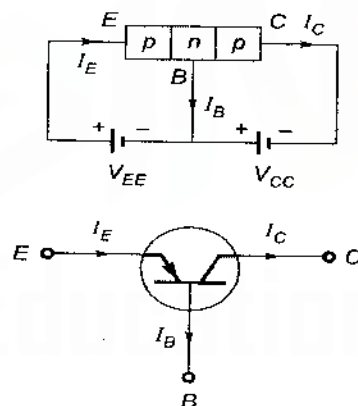

(a) *pnp* transistor

Transistor Sections

1. **Emitter:** It is heavily doped as comparison to other regions. The main function of this region is to supply majority charge carrier i.e. either electrons or holes.

2. **Base:** This section is very lightly doped and very thin as compare to other section. Its main function is to transfer the majority carriers from emitter to collector.
3. **Collector:** This section is moderately doped and has largest area than other two regions because it collects the charge carries from emitter and base. There is a large amount of heat liberation and so it is provided with large area to dissipate the heat.

BJT Configuration

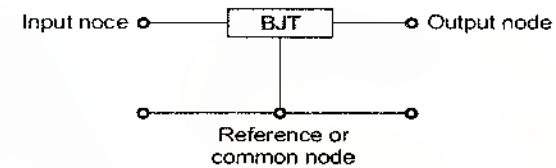

Based on the reference node a BJT can be used in 3 configuration as given in table below:

Configuration	Input node	Output node
Common Base (CB)	E	C
Common Emitter (CE)	B	C
Common Collector (CC)	B	E

Mode of Operation

Mode	Emitter-base junction	Collector-base junction	Properties	Application
Cut-off	Reverse bias	Reverse bias	Very high internal resistance	OFF-switch
Active	Forward bias	Reverse bias	Excellent transistor action	Amplifier
Saturation	Forward bias	Forward bias	Very low internal resistance	ON-switch
Reverse active	Reverse bias	Forward bias	Very poor transistor action	Attenuator (Practically not used)

1. Common Base Configuration

$$I_E = I_B + I_C + I_{CBO}$$

$$\text{or } I_E \approx I_B + I_C$$

where, I_E = Emitter current

I_B = Base current

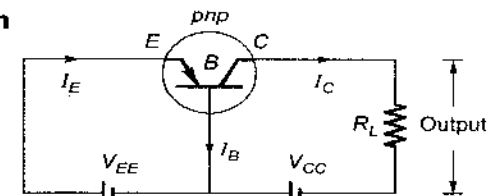

Common base *pnp* transistor

FOR MORE EXCLUSIVE
(Civil, Mechanical, EEE, ECE)
ENGINEERING & GENERAL STUDIES
(Competitive Exams)

TEXT BOOKS, IES GATE PSU's TANCET & GOVT EXAMS
NOTES & ANNA UNIVERSITY STUDY MATERIALS

VISIT

www.EasyEngineering.net

**AN EXCLUSIVE WEBSITE FOR ENGINEERING STUDENTS &
GRADUATES**



****Note:** Other Websites/Blogs Owners Please do not Copy (or) Republish this Materials without Legal Permission of the Publishers.

****Disclimers :** EasyEngineering not the original publisher of this Book/Material on net. This e-book/Material has been collected from other sources of net.

I_C = Collector current

I_{CBO} = Collector to base leakage current

Note:

$$I_B \approx 2\% \text{ of } I_E ; I_C \approx 98\% \text{ of } I_E.$$

Current amplification factor (α)

When no signal is applied then the ratio of the collector current to emitter current is called current amplification factor or current gain.

$$\alpha = \frac{I_C}{I_E} = 98\%$$

Note:

α of a transistor is a measure of the quality of transistor. Higher is the value of α better is the transistor as I_C approaches I_E .

Collector current also be expressed as

$$I_C = \alpha I_E + I_{CBO}$$

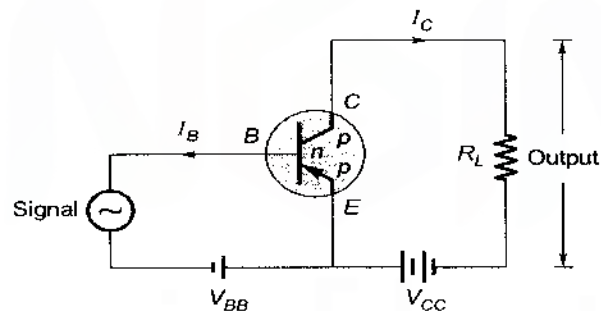
2. Common Emitter Configuration

Common emitter pnp transistor

Base current amplification factor (β)

When no signal is applied, then the ratio of collector current to the base current is called β .

$$\beta = \frac{I_C}{I_B} ; \text{ Also } \alpha = \frac{\beta}{1 + \beta}$$

Note:

- β ranges from 20 to 500.
- This configuration is used when appreciable current gain as well as voltage gain is required.

Total collector current

$$I_C = \beta I_B + I_{CEO} \quad (\text{or}) \quad I_C = \beta I_B + (1 + \beta) I_{CBO}$$

where, I_{CEO} = Collector to emitter leakage current

$$I_{CEO} = (1 + \beta) I_{CBO}$$

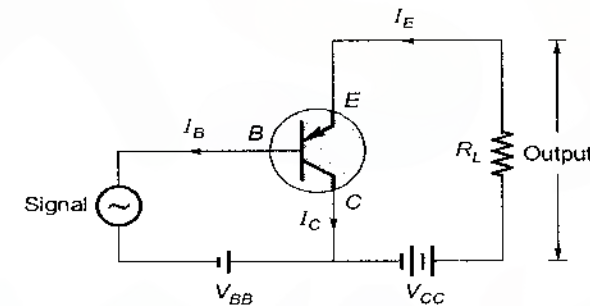
3. Common Collector Configuration

Common emitter pnp transistor

Current amplification factor (γ)

When no signal is applied then the ratio of emitter current to the base current is called γ of the transistor.

$$\gamma = \frac{I_E}{I_B} ; \quad \gamma = 1 + \beta = \frac{1}{1 - \alpha}$$

Total emitter current

$$I_E = (1 + \beta) I_B + (1 + \beta) I_{CBO}$$

Note:

- This configuration has very high input resistance $\approx 750 \text{ k}\Omega$ and very low output resistance.
- Voltage gain is always less than one so never used for amplification purpose.
- This configuration is used for impedance matching i.e. driving a low impedance load from a high impedance source.

Characteristics	CB Configuration	CE Configuration	CC Configuration
Input resistance	Very low (40 Ω)	Low (50 kΩ)	Very high (750 kΩ)
Output resistance	Very high (1 MΩ)	High (10 kΩ)	Low (50 Ω)
Current gain	Less than unity	High (100)	High (100)
Voltage gain	Small (150)	High (500)	Less than unity
Leakage current	Very small	Very large	Very large
Applications	For high frequency applications	For audio frequency applications	For impedance matching
Phase shift between input and output	0°	180°	0°

Input and Output Characteristics of Different Configuration

The collector current I_C is completely determined by the input current I_E and the V_{CB} voltage.

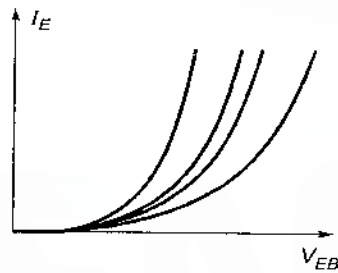

Input characteristics of CB configuration

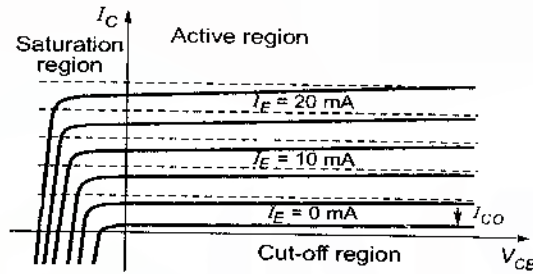

Output characteristics of CB configuration

The curve between I_B and V_{BE} for different values of V_{CE} are shown in figure.

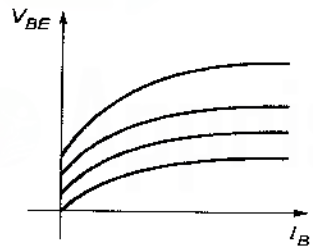

Input characteristics of CE configuration

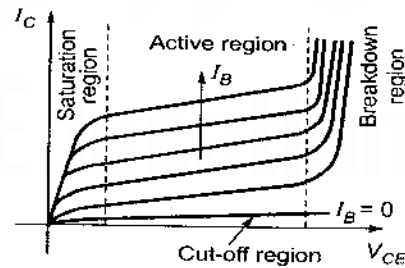

Output characteristics of CE configuration

The output characteristics are the curve between V_{CE} and I_C for various values of I_B .

DC Load Lines

- DC load line is the locus of all possible operating point at which BJT remains in active region.

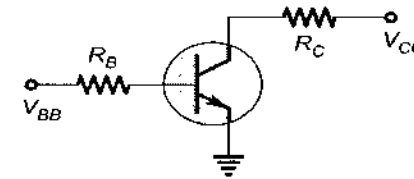

- If base current $I_B < \frac{I_{C\text{ sat}}}{\beta}$ then transistor operate in active region.

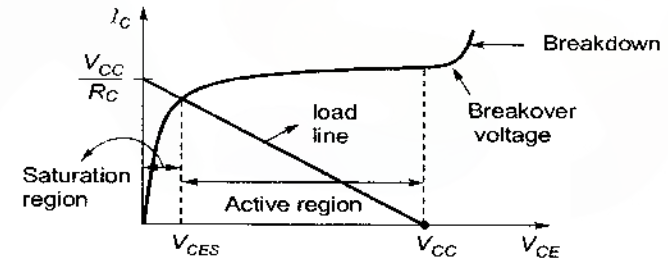

- If $I_B > \frac{I_{C\text{ sat}}}{\beta}$ then it operates in saturation region.

- Collector current $I_C = \frac{V_{CC} - V_{CE}}{R_C}$ for above figure.

at saturation, $V_{CE} = V_{CES}$.

- $V_{CE} = V_{CC}$ at cutoff when $I_C = 0$.
- Maximum value of current

$$I_{C\text{ max}} = \frac{V_{CC}}{R_C} \quad \text{[Taking } V_{CE} = 0 \text{ at saturation]}$$

This is the ideal case.

- Power dissipated in a transistor is $P_D = I_C V_{CE}$

Remember:

Power dissipation is maximum in active region and minimum in cutoff region and saturation region.



Transistor Biasing Circuits

4

Biasing is about stabilizing I_C and V_{CE} so as to ensure that transistor remains in active region for entire range of input signal.

Fixed Bias

$$I_C = \frac{V_{CC} - V_{CE}}{R_C}$$

$$I_B = \frac{V_{CC} - V_{BE}}{R_B}$$

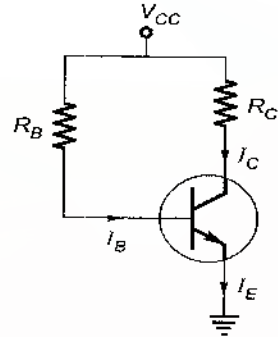

Emitter feedback bias

- Collector current I_C

$$I_C \cong \frac{V_{CC} - V_{CE}}{R_E + R_C}$$

(assuming β to be large)

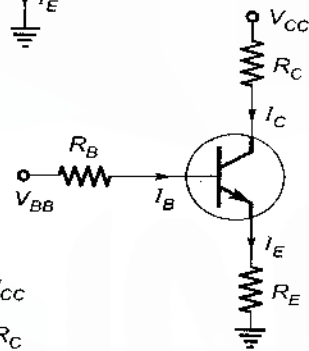

Collector-feedback bias (self bias)

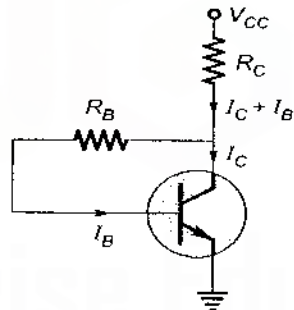

$$I_C \cong \frac{V_{CC} - V_{CE}}{R_C}$$

[Assuming β to be large or $I_B \approx 0$]

or

$$I_C = \left[\frac{V_{CC} - V_{CE}}{R_C} \right] \times \left(\frac{\beta}{\beta + 1} \right)$$

[Exact value]

Voltage Divider Bias (universal bias)

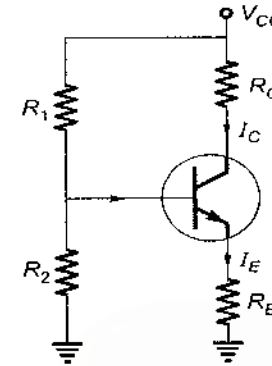

- Widely used in linear circuits and is as Equivalent circuit will be \rightarrow (thevenine equivalent)

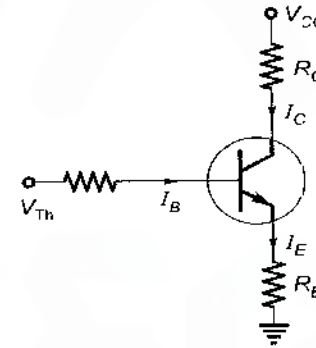

where, $V_{Th} = \frac{R_2}{R_1 + R_2} V_{CC}$

$$R_{Th} = R_1 \parallel R_2$$

$$I_C \cong \frac{V_{CC} - V_{CE}}{R_C + R_E}$$

[Assuming β to be large]

$$I_E = \frac{V_{Th} - V_{BE}}{R_E + \left(\frac{R_{Th}}{\beta + 1} \right)}$$

Bias Stabilization

- Stabilization is about making the Q-point independent of changes in temperature and changes in transistor parameters.
- If I_{CO} , V_{BE} and β changes simultaneously then net change in I_C .

$$\Delta I_C = \frac{\partial I_C}{\partial I_{CO}} \Delta I_{CO} + \frac{\partial I_C}{\partial V_{BE}} \Delta V_{BE} + \frac{\partial I_C}{\partial \beta} \Delta \beta$$

where, $\frac{\partial I_C}{\partial I_{CO}} = S \rightarrow$ Current stability factor.

$\frac{\partial I_C}{\partial V_{BE}} = S' \rightarrow$ Voltage stability factor

$\frac{\partial I_C}{\partial \beta} = S_{\beta}$ or $S'' \rightarrow$ Amplification stability factor.

Note:

Out of three stability factor S is most significant reason being, it S is within tolerable limit then other S' and S'' are guaranteed to remain within tolerable limit.

$$S_{\text{ideal}} = 1$$

Practically S should be less than 20.

For Voltage Divider Bias Circuit

current stability factor,

$$S = \frac{(\beta + 1)(R_{Th} + R_E)}{R_{Th} + (\beta + 1)R_E}$$

Note:

R_E must be large for lesser value of S , but it also decreases the gain.

- Alternate Evaluation of S

$$S = \frac{(\beta + 1)}{1 - \beta \frac{\partial I_B}{I_C}}$$

- Condition for effective stabilization

$$S = \frac{(\beta + 1)(R_E + R_{Th})}{R_{Th} + (\beta + 1)R_E} \quad \text{[For voltage divider circuit]}$$

$$S = \frac{(\beta + 1)}{1 + \frac{\beta}{\left(1 + \frac{R_{Th}}{R_E}\right)}} \quad ; \text{ if } \frac{R_{Th}}{R_E} \ll 1 \text{ then } S \rightarrow 1$$

For Collector Feedback Bias Circuit

$$S = \frac{(1 + \beta)(R_B + R_C)}{R_B + (1 + \beta)R_C} \quad ; \text{ if } \frac{R_B}{R_C} \ll 1 \text{ then } S \rightarrow 1$$

For Fixed Bias Circuit

$$S = (\beta + 1) \rightarrow \text{very large} \rightarrow \text{highly unstable.}$$

Condition to Avoid Thermal Run Away

- Thermal resistance (θ)

$$\theta = \frac{T_J - T_A}{P_D} \quad (^\circ\text{C/Watt or } ^\circ\text{K/Watt})$$

where,

T_J = Junction temperature (collector junction)

T_A = Ambient temperature in Kelvin.

P_D = Power dissipated across collector junction.

- A transistor will be thermally stable if

$$\frac{\partial P_C}{\partial T_J} < \frac{\partial P_D}{\partial T_J} < \frac{1}{\theta} \quad \frac{\partial P_C}{\partial T_J} \rightarrow \text{Rate at which heat is released.}$$

$$\frac{\partial P_D}{\partial T_J} \rightarrow \text{Rate at which heat is dissipated.}$$

- For thermal stability $\frac{V_{CC}}{2} > V_{CE}$.



BJT as an Amplifier

Common Emitter Amplifier

Output voltage

$$V_{out} \cong -I_E R_C$$

Voltage gain

$$A = \frac{V_{out}}{V_{in}} \cong -\frac{R_C}{r'_e}$$

Input impedance

$$Z_{in} \cong R_1 \parallel R_2 \parallel \beta r'_e$$

Input impedance of base

$$Z_{in(base)} \cong \frac{\beta I_b r'_e}{I_b} = \beta r'_e$$

Output impedance

$$Z_{out} \cong R_C$$

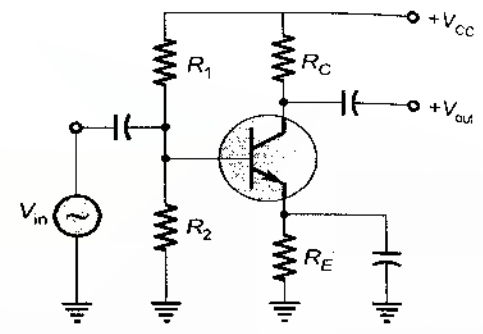

Swamped Amplifier

Effect of swamping on voltage gain

$$A \cong -\frac{R_C}{R_E + r'_e}$$

Input impedance of base

$$Z_{in(base)} \cong \beta(R_E + r'_e)$$

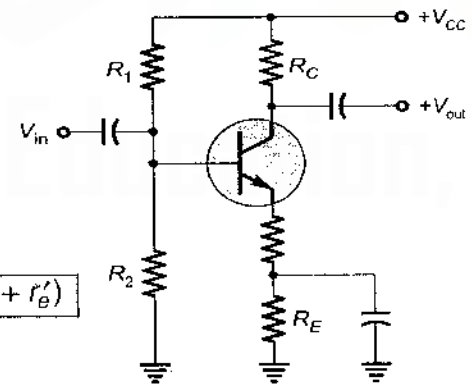

Common Base Amplifier

Input impedance

$$Z_{in} \cong r'_e$$

Voltage gain

$$A = \frac{V_{out}}{V_{in}} \cong \frac{R_C}{r'_e}$$

Output impedance

$$Z_{out} \cong R_C$$

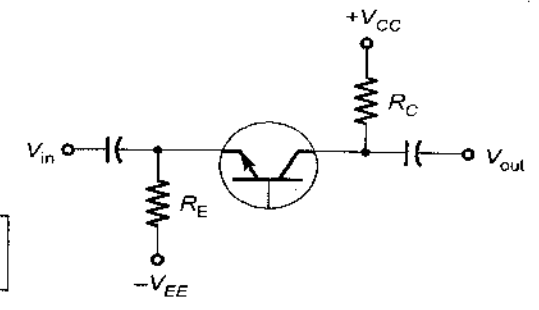

Common Collector Amplifier (or Emitter Follower)

DC output voltage

$$V_{out} = V_{in} - V_{BE}$$

Voltage gain

$$A = \frac{V_{out}}{V_{in}} = \frac{R_E}{R_E + r'_e} \cong 1$$

Input impedance

$$Z_{in} = R_1 \parallel R_2 \parallel \beta R_E$$

Input impedance of base

$$Z_{in(base)} = \beta(R_E + r'_e) \cong \beta R_E$$

Output impedance

$$Z_{out} = r'_e + \frac{R_s \parallel R_1 \parallel R_2}{\beta}$$

Voltage gain

$$A = \frac{R_E}{R_E + r'_e + (R_s \parallel R_1 \parallel R_2)/\beta} \cong 1$$

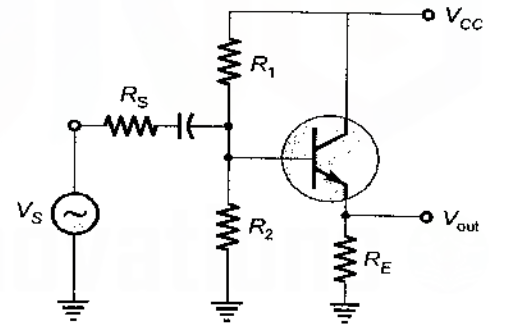
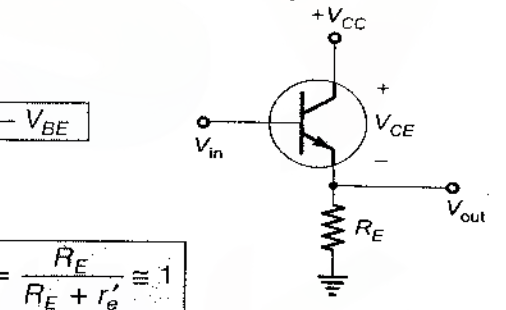

Darlington Amplifier

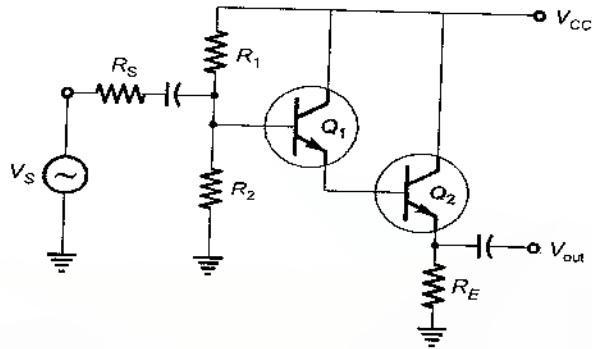

Input impedance of second stage

$$Z_{in(2)} \cong \beta_2 R_E$$

Input impedance of first stage

$$Z_{in(1)} = \beta_1 \beta_2 R_E$$

AC Thevenin impedance at input

$$R_{Th} = R_s \parallel R_1 \parallel R_2$$

Output impedance of first stage

$$Z_{out(2)} = r_{e1}' + \frac{R_{Th}}{\beta_1}$$

Output impedance of second stage

$$Z_{out(2)} = r_{e2}' + \frac{r_{e1}' + R_{Th}/\beta_1}{\beta_2}$$

Note:

- Input impedance of common collector amplifier is highest among CE, CB and CC.
- Output impedance of common collector is lowest among CE, CB and CC.
- Darlington pair is known as super β circuit.
- Darlington pair is used where very high input impedance and high current gain is required.
- Voltage gain of CB is highest and current gain of CC is highest.
- CE has highest power gain.



Junction Field Effect Transistors

6

- FET is a unipolar and voltage controlled device.
- The terminals drain, gate and source of a FET are identical to collector base and emitter of a BJT.
- Since the input junction is reverse biased in JFET, the current drawn is very small and so input impedance is very high.
- Less noisy device due to absence of minority carriers.
- Excellent thermal stability due to absence of leakage current.
- FET is considered as excellent signal chopper because of zero offset voltage.

Circuit Diagram and Symbol

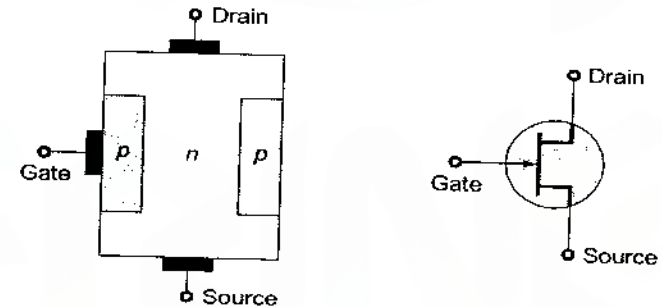

Parameters

Drain current

$$I_D = I_{DSS} \left[1 - \frac{V_{GS}}{V_p} \right]^2$$

In saturation region

where,

 I_D = Drain current I_{DSS} = Maximum value of current when $V_{GS} = 0$ V_p = Pinch off voltage V_{GS} = Gate to source voltage

Drain resistance

$$r_d = \left. \frac{\Delta V_{DS}}{\Delta I_{DS}} \right|_{V_{GS} = \text{constant}}$$

Note:

r_d ranges from 100 k Ω to 500 k Ω .

Transconductance

$$g_m = \left. \frac{\Delta I_D}{\Delta V_{GS}} \right|_{V_{DS} = \text{constant}}$$

Note:

g_m ranges from 0.1 mS to 10 mS.

In saturation region

$$g_m = -\frac{2I_{DSS}}{V_p} \left(1 - \frac{V_{GS}}{V_p}\right) = -\frac{2}{V_p} \sqrt{I_D \cdot I_{DSS}}$$

Also,

$$g_m = g_{mo} \left(1 - \frac{V_{GS}}{V_p}\right)$$

where,

$$g_{mo} = -\frac{2I_{DSS}}{V_p} = \text{maximum value of transconductance}$$

Amplification Factor

$$\mu = \left. \left(\frac{\Delta V_{DS}}{\Delta V_{GS}} \right) \right|_{I_D = \text{Constant}}$$

Note:

- μ ranges from 2.5 to 150.
- Relation between μ , r_d and g_m is $\mu = r_d \cdot g_m$.

Remember:

If two FETs are connected in parallel having transconductance g_{m1} and g_{m2} , drain resistance r_{d1} and r_{d2} , amplification factor μ_1 and μ_2 then

Effective transconductance $g_m = g_{m1} + g_{m2}$.

Effective drain resistance $r_d = r_{d1} \parallel r_{d2}$.

Effective amplification factor $\mu = \frac{\mu_1 r_{d2} + \mu_2 r_{d1}}{\mu_1 + \mu_2}$.

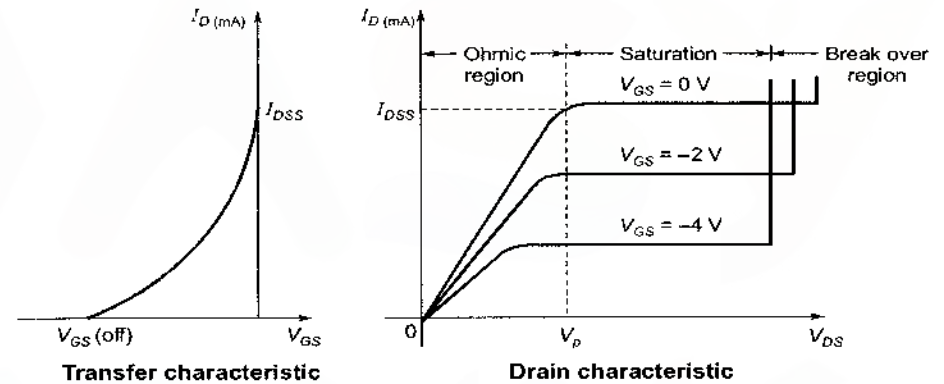
Characteristics of JFET**Remember:**

When FET is operated below pinch-off voltage (V_p), it acts as a voltage variable resistor.

FET Amplifiers**Common Source Amplifier****AC output voltage**

$$V_{out} = -g_m V_{GS} R_D$$

Unloaded voltage gain

$$A = -g_m R_D$$

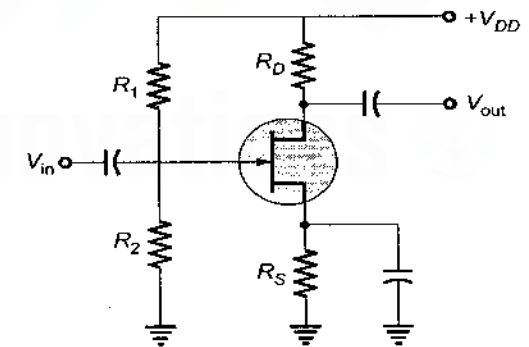

Common Drain (CD) Amplifier

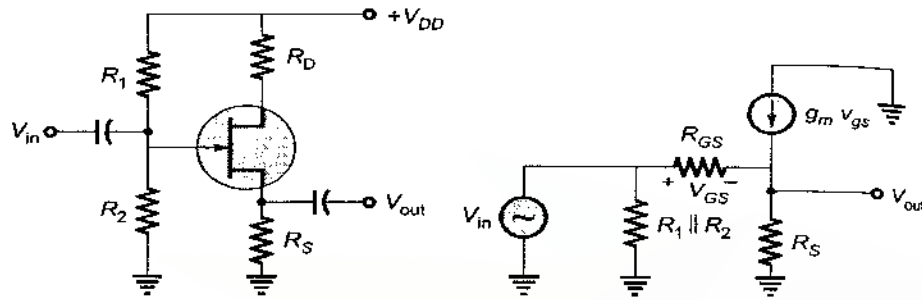

AC input voltage

$$V_{in} = (1 + g_m R_S) V_{GS}$$

AC output voltage

$$V_{out} = g_m V_{GS} R_S$$

Unloaded voltage gain

$$A = \frac{R_S}{R_S + 1/g_m} \cong 1 \quad \dots (\text{as } R_S \gg 1/g_m)$$

Output impedance

$$Z_{out(source)} = 1/g_m \quad ; \quad Z_{out} = R_S \parallel 1/g_m$$

Common Gate (CG) Amplifier

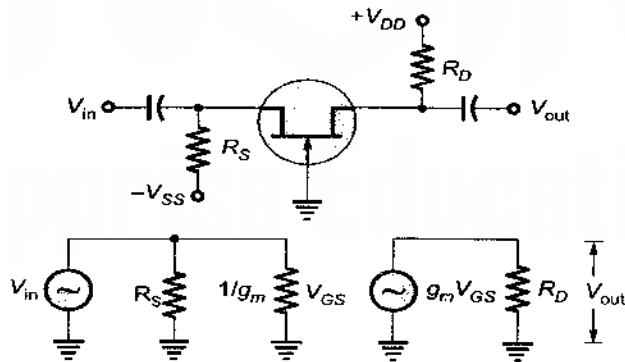

AC equivalent circuit

AC input voltage

$$V_{in} = V_{GS}$$

AC output voltage

$$V_{out} = g_m V_{GS} R_D$$

Unloaded voltage gain

$$A = g_m R_D$$

Input impedance

$$Z_{in} = \frac{1}{g_m}$$

DC on-state resistance

$$r_{DS(on)} = \frac{V_{DS}}{I_D}$$

where, $r_{DS(on)}$ = DC resistance in saturation region
 V_{DS} = DC drain-source voltage
 I_D = DC drain current

FET Biasing Circuit

Self bias circuit

Gate to source voltage

$$V_{GS} = -I_D R_S$$

Source resistance

$$R_S = -V_p / I_{DSS}$$

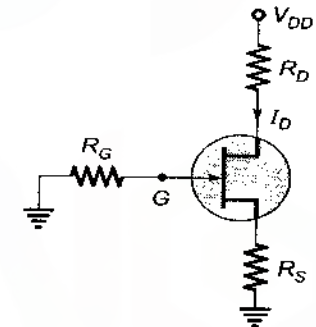

Note:

Q-point is the intersection between the transconductance and the self bias line.

Voltage divider/Source bias circuit

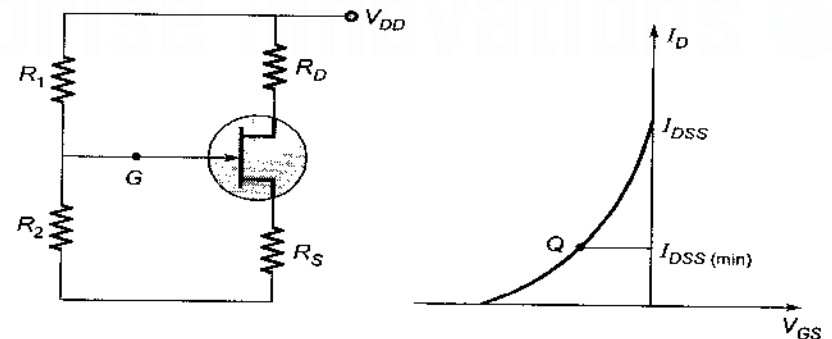

Drain current

$$I_D = \frac{V_{Th} - V_{GS}}{R_s} \quad \text{where, } V_{Th} = \left(\frac{R_2}{R_1 + R_2} \right) V_{DD}$$

Current source bias circuit

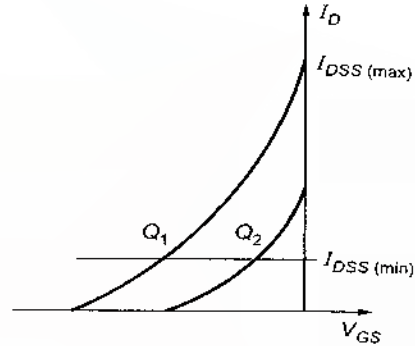
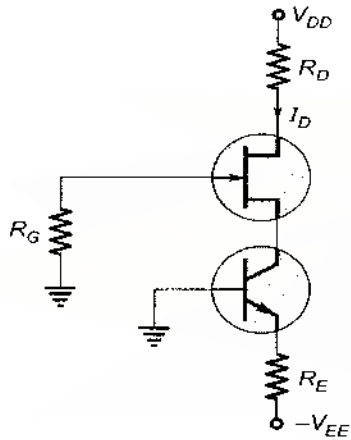

Collector current

$$I_C = I_D = \frac{V_{EE} - V_{BE}}{R_E}$$



Metal Oxide Semiconductor Field Effect Transistor

- MOSFET is an integrated device, fabricated by VLSI using planner technology.
- It is a voltage controlled device.
- In the MOSFET the plate and semiconductor channel will be working as the plate of capacitor and SiO₂ as dielectric.
- The large input impedance of MOSFET is due to the SiO₂.
- MOSFET is very sensitive to static electrical noise and static electrical disturbances.

Schematic Symbol

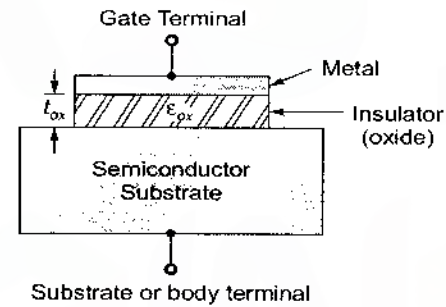

p-channel Depletion MOSFET

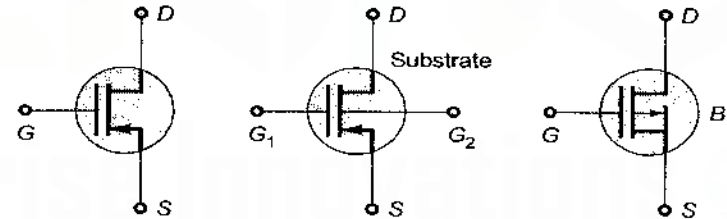

n-channel Depletion MOSFET

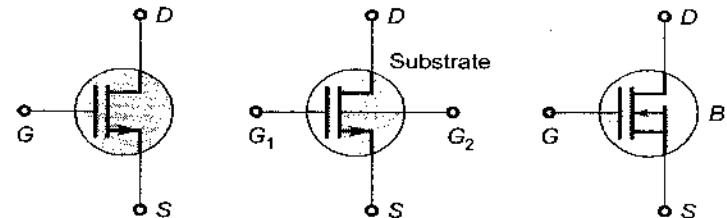

p-Channel Enhancement MOSFET

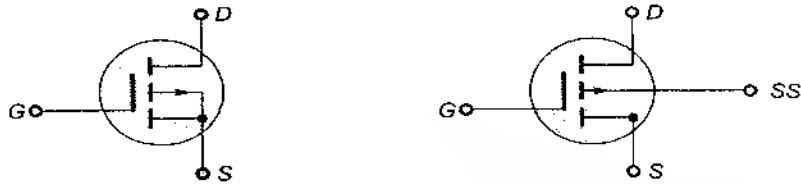

n-Channel Enhancement MOSFET

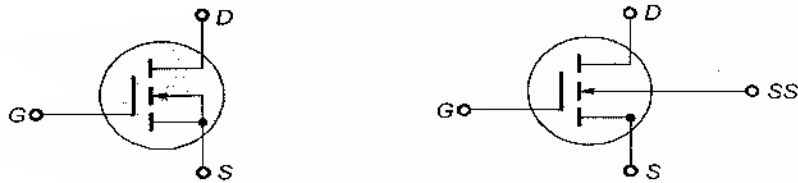

Characteristics of MOSFET

For depletion MOSFET characteristics are same as JFET characteristics.

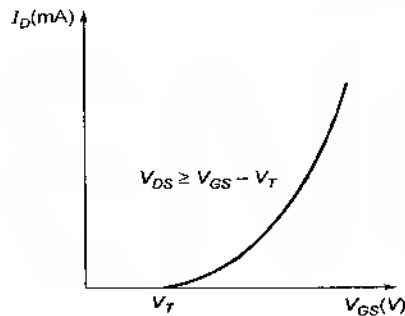

Transfer characteristic of E-MOSFET

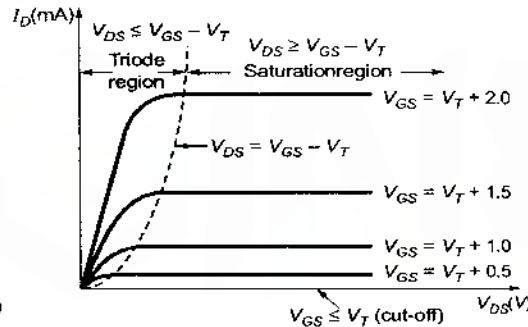

Drain characteristic of E-MOSFET

Remember:

- Threshold voltage (V_T) is defined as the "Minimum gate to source voltage required for MOSFET turn into ON state".
- For better performance of the MOSFET, threshold voltage must be as small as possible.
- The threshold voltage of MOSFET can be graphically obtained from the transfer characteristics.
- Threshold voltage V_T should be smaller.

Parameters

For depletion MOSFET

Drain current,

$$I_D = I_{DSS} \left(1 - \frac{V_{GS}}{V_P} \right)^2$$

where, $I_{DSS} = I_{Dmax}$

Note:

In depletion MOSFET channel is pre-existing.

For enhancement type n-channel MOSFET

- $V_{GS} > V_T$ for 'ON' or saturation region.
- $V_{GS} < V_T$ for 'OFF' or cut-off region.
- where, $V_T =$ Threshold voltage
- $V_{DS} < (V_{GS} - V_T) \rightarrow$ Triode region of operation.
- $V_{DS} \geq (V_{GS} - V_T) \rightarrow$ Saturation region of operation.
- For saturation region

$$I_D = K(V_{GS} - V_T)^2$$

- For p-channel MOSFET

$$I_D = K(V_{GS} + V_T)^2$$

Note:

In enhancement MOSFET channel is diffused channel.

Remember:

- MOSFET is less noisy as compared to JFET.
- MOSFET is faster than JFET but BJT is faster than MOSFET.
- When compare to BJT, MOSFET is more suitable for high frequency application.



Transistor Hybrid Model



Approximated Conversion Formulae for h-paramters

CE to CC	CE to CB
$h_{ic} = h_{ie}$	$h_{ib} = \frac{h_{ie}}{1 + h_{fe}}$
$h_{rc} = 1$	$h_{rb} = \frac{h_{ie} h_{oe}}{1 + h_{fe}} - h_{re}$
$h_{fc} = -(1 + h_{fe})$	$h_{fb} = \frac{-h_{fe}}{1 + h_{fe}}$
$h_{oc} = h_{oe}$	$h_{ob} = \frac{h_{oe}}{1 + h_{fe}}$

Introduction

The h-parameter model of BJT is defined by two-port network as

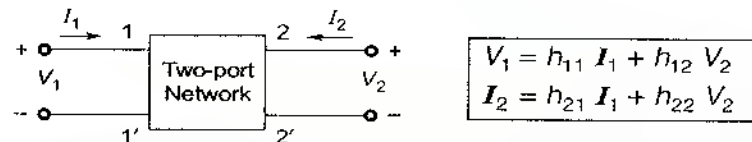

Input impedance h_{11}/h_i

$$h_{11} = \left. \frac{V_1}{I_1} \right|_{V_2=0}$$

Current gain h_{21}/h_f

$$h_{21} = \left. \frac{I_2}{I_1} \right|_{V_2=0}$$

Reverse voltage gain h_{12}/h_r

$$h_{12} = \left. \frac{V_1}{V_2} \right|_{I_1=0}$$

Output Admittance h_{22}/h_o

$$h_{22} = \left. \frac{I_2}{V_2} \right|_{I_1=0}$$

Typical h-paramter Values for Transistors

Parameters	CE	CC	CB
$h_{11} = h_i$	1.1 kΩ	1.1 kΩ	21.6 Ω
$h_{12} = h_r$	2.5×10^{-4}	1	2.9×10^{-4}
$h_{21} = h_f$	50	-51	-0.98
$h_{22} = h_o$	24 μA/V	24 μA/V	0.49 μA/V
$1/h_o$	40 kΩ	40 kΩ	2.04 MΩ

Hybrid Model

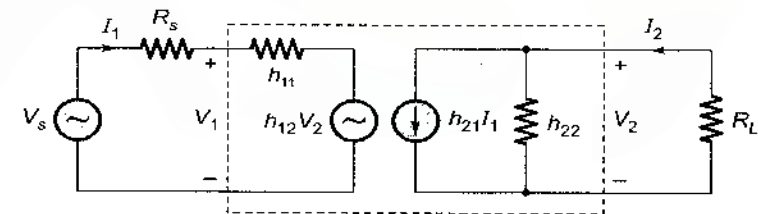

Current gain

$$A_f = \frac{I_2}{I_1} = \frac{-h_{21}}{1 + h_{22} R_L} = \frac{-h_f}{1 + h_o R_L}$$

where, I_1 = AC input current
 I_2 = AC output current

Voltage gain

$$A_v = \frac{V_2}{V_1}$$

where, V_1 = AC input voltage
 V_2 = AC output voltage

$$A_v = \frac{-h_{21} R_L}{h_{11} + (h_{11} h_{22} - h_{12} h_{21}) R_L} = \frac{-h_f R_L}{h_i + (h_i h_o - h_r h_f) R_L}$$

Input impedance

$$Z_{in} = \frac{V_1}{I_1} = h_{11} - \frac{h_{12} h_{21} R_L}{1 + h_{22} R_L} = h_i - \frac{h_r h_f R_L}{1 + h_o R_L}$$

Output impedance

$$Z_{out} = \frac{V_2}{I_2} = \frac{R_s + h_{11}}{(R_s + h_{11})h_{22} - h_{12}h_{21}} = \frac{R_s + h_{11}}{(R_s + h_{11})h_o - h_r h_f}$$

$$Y_{out} = h_o - \frac{h_r h_f}{h_i + R_s}$$

Multistage Amplifier

- Upper cutoff frequency of overall configuration is

$$f_H^* = f_H \sqrt{2^{1/n} - 1} \quad (\text{For identical amplifiers in cascade})$$

where, n = number of amplifiers in cascade

f_H = upper cutoff frequency of one amplifier

- Lower cutoff frequency of overall configuration

$$f_L^* = \frac{f_L}{\sqrt{2^{1/n} - 1}} \quad \text{where, } n = \text{number of identical amplifiers in cascade}$$

Approximate BW of amplifier in cascade is f_H^* .

- When amplifiers are non-identical then

$$f_L^* = 1.1 \sqrt{f_{L1}^2 + f_{L2}^2 + f_{L3}^2 + \dots + f_{Ln}^2} \quad \text{and} \quad \frac{1}{f_H^*} = 1.1 \sqrt{\frac{1}{f_{H1}^2} + \frac{1}{f_{H2}^2} + \dots + \frac{1}{f_{Hn}^2}}$$

- Rise time $t_r^* = 1.1 \sqrt{t_{r1}^2 + t_{r2}^2 + \dots + t_{rn}^2}$

■■■■

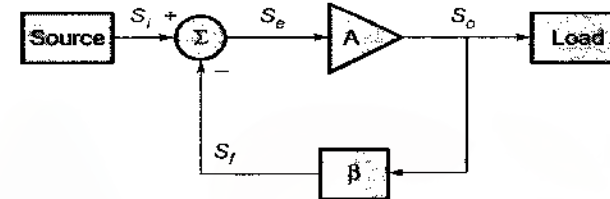
Feedback Amplifiers**Basic Feedback Concept**

where, A = Open loop gain
 β = Feedback factor
 S_i = Input signal
 S_e = Error signal
 S_f = Feedback signal

Gain with feedback

$$A_f = \frac{A}{1 + A\beta} \quad \text{for -ve feedback ;} \quad A_f = \frac{A}{1 - A\beta} \quad \text{for +ve feedback}$$

Remember:

The amount of feedback introduced into amplifier is often expressed in dB and is given by

$$N(\text{Feedback in dB}) = 20 \log \left| \frac{1}{1 + A\beta} \right|$$

Here, $N \rightarrow -ve$ for $-ve$ feedback and $N \rightarrow +ve$ for $+ve$ feedback.

Loop gain or return ratio

$$\text{Loop gain} = -A\beta$$

Return difference

- Difference between unity and loop gain is called *return difference (D)*.

$$D = (1 + A\beta)$$

- D is also called *desensitivity*.

Sensitivity

In case of negative feedback if,

$$\frac{dA}{A} \rightarrow \% \text{ change without feedback.}$$

$$\frac{dA_f}{A_f} \rightarrow \% \text{ change with feedback.}$$

$$\frac{dA_f}{A_f} = \frac{dA/A}{1 + A\beta} \quad \text{i.e. reduction in sensitivity of amplifier.}$$

General Block Diagram of Feedback Network.

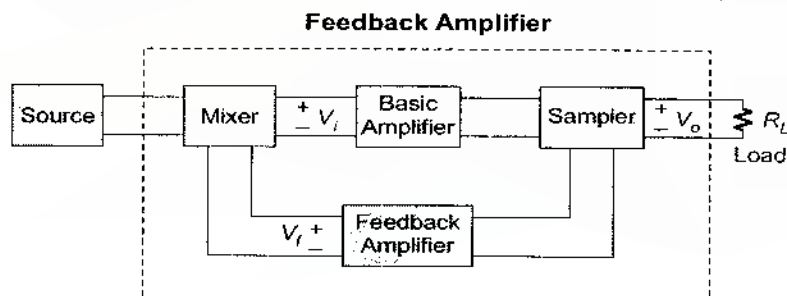

Sample Circuit	Mixer (Comparator)
<p>1. Voltage/Shunt Sampler</p>	<p>1. Series/Voltage Mixer (Comparator)</p>
<p>2. Current/Series Sampler</p>	<p>2. Shunt/Current Mixer (Comparator)</p>

Effect of Feedback

- Reduction in noise

$$N_{of} = \frac{N_o}{1 + A\beta}$$

N_o = Noise without feedback

N_{of} = Noise with feedback

- Lower cutoff frequency

$$f_{Hf} = \left(\frac{f_i}{1 + A\beta} \right)$$

f_{Hf} = Lower 3-dB frequency with feedback

f_i = Lower 3-dB frequency without feedback

- Upper cutoff frequency $f_{Hf} = f_H(1 + A\beta)$

where, f_{Hf} = Upper 3-dB frequency with feedback.

f_H = Upper 3-dB frequency without feedback.

Note:

Bandwidth increases with -ve feedback.

Feedback Topology

1. Voltage series topology

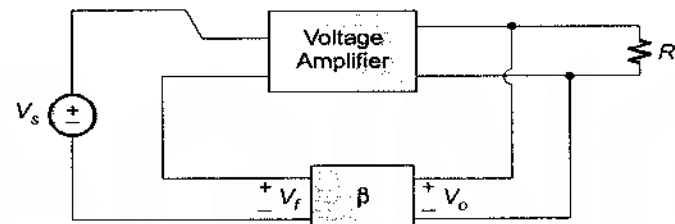

(i) β is dimensionless.

(ii) Voltage series feedback stabilizes the voltage gain.

2. Current series topology

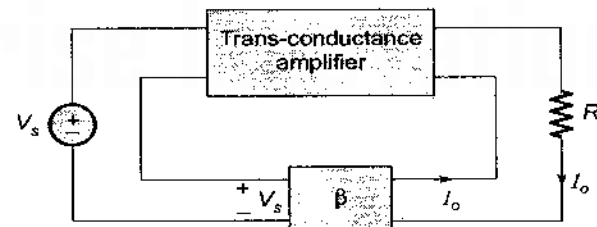

(i) Unit of β is Ohm.

(ii) It stabilizes trans-conductance gain of the amplifier.

3. Voltage shunt topology

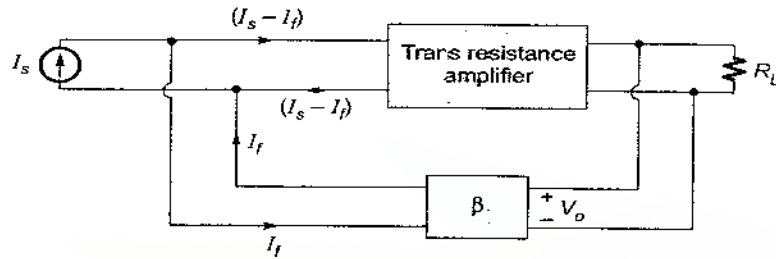

- (i) β has unit mho.
- (ii) It stabilizes the trans-resistance gain of the amplifier.

4. Current shunt topology

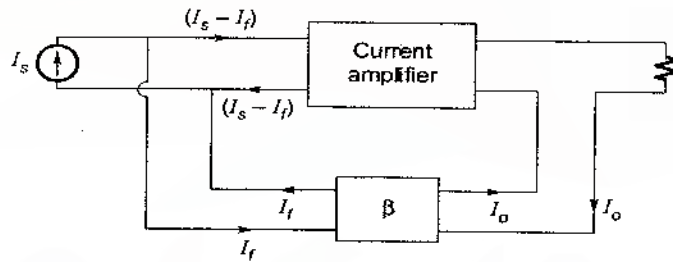

- (i) β has no unit.
- (ii) It stabilizes the current gain of the amplifier.
- For different feedback configurations effect on input and output impedance

Feedback	Input	Output	Gain	R_i	R_o
Voltage series	Voltage	Voltage	A_v	↑	↓
Current series	Voltage	Current	G_m	↑	↑
Voltage shunt	Current	Voltage	R_m	↓	↓
Current shunt	Current	Current	A_I	↓	↑

Note:

- Voltage series feedback, is the best arrangement in terms of R_i and R_o .
- Current shunt is the worst for the same.

Remember:

Procedure to Identify the Type of Feedback:

- Identify the element responsible for the feedback.
- If feedback element is directly connected to output node, it indicates voltage sampling otherwise it indicates current sampling.
- If feedback element is directly connected to the input node, it indicates shunt mixing otherwise it indicates series mixing.



Operational Amplifiers

10

Differential Amplifier

- Here, $V_{out} = A(V_1 - V_2)$
where, V_{out} = Voltage between collectors

$$A = \frac{R_C}{R_E}$$

- where, R_E = Emitter resistance
- V_1 = Noninverting input voltage
- V_2 = Inverting input voltage

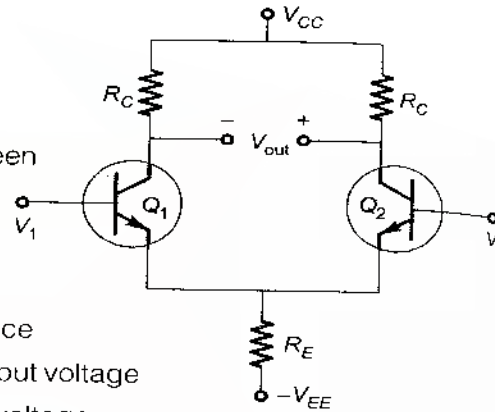

DC Analysis of a Differential Amplifier

- Emitter bias current

$$I_E = \frac{V_{EE} - V_{BE}}{2R_E}$$

- Tail current

$$I_T = \frac{V_{EE} - V_{BE}}{R_E}$$

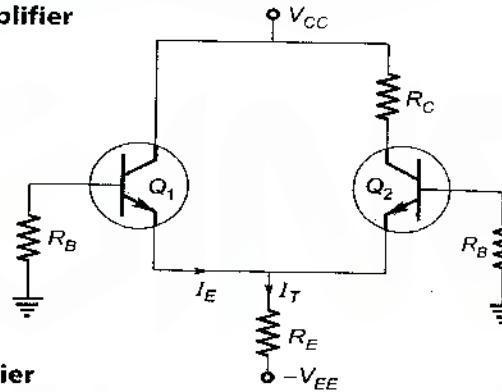

AC Analysis of a Different Amplifier

1. Non-inverting input

- AC emitter current

$$I_E = \frac{V_1}{2R_E} \quad \text{where, } R_E = \text{emitter resistance}$$

- AC output voltage is $V_{out} = I_C R_C = \frac{V_1}{2R_E} R_C$

- Voltage gain for noninverting input is $\frac{V_{out}}{V_1} = \frac{R_C}{2R_E}$

2. Inverting input

- AC emitter current is $I_E = \frac{V_2}{2R_E}$

- AC output voltage is $V_{out} = -I_C R_C = -\frac{V_2}{2R_E} R_C$

- Voltage gain for inverting input is $\frac{V_{out}}{V_2} = \frac{R_C}{2R_E}$

- Differential Voltage gain $A = \frac{R_C}{2R_E}$

- Input impedance $R_{in} = 2\beta R_E$

Common Mode Voltage Gain

$$A_{CM} = \frac{V_{out}}{V_{in(CM)}} = -\frac{R_C}{r_e + 2R_E} \approx -\frac{R_C}{2R_E}$$

$$CMRR = \frac{A}{-A_{CM}}$$

where, $A_{CM} \rightarrow$ common mode gain

Note:

$$R_E \gg r_e$$

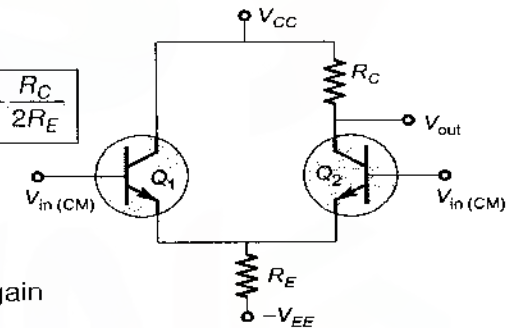

Operational Amplifier

An op-Amp is basically a very high gain, direct-coupled amplifier with high input impedance and low output impedance.

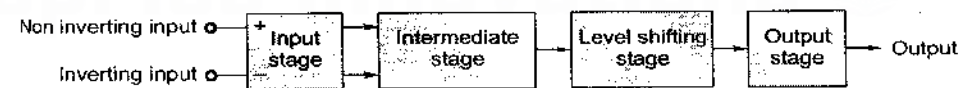

Equivalent circuit of an Op-Amp

Op-amp amplifies the difference between the two input signals applied at non inverting and inverting input terminals.

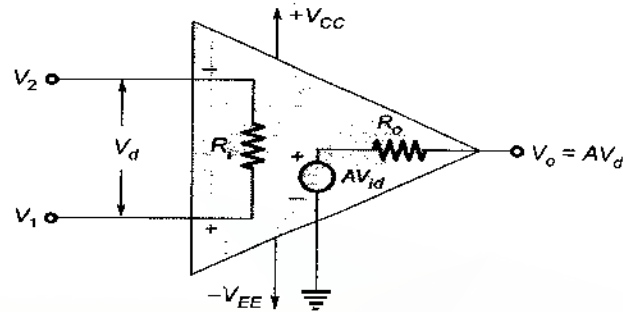

Equivalent circuit of op-amp

where,

Difference input voltage $V_d = V_1 - V_2$

A = Open loop gain of op-amp

Output voltage $V_o = AV_d$

R_i = Differential input resistance

R_o = Output resistance

Properties of Op-Amp

Parameters	Ideal value	Practical value
Voltage gain	∞	10^6
Input resistance	∞	$10^6 \Omega$ or $1 M\Omega$
Output resistance	0	10Ω to 100Ω
B.W.	∞	10^6 Hz or 1 MHz
CMRR	∞	10^6 or 120 dB
Slew rate	∞	$80V/\mu$ sec.

Slew rate

For input $V_m \sin \omega t$

$$f_{max} = \frac{SR}{2\pi A_{CL} V_m}$$

where, SR = Slew rate

f_{max} = Maximum frequency of operation

A_{CL} = Closed loop gain of OP-AMP.

Bias Currents and Voltage

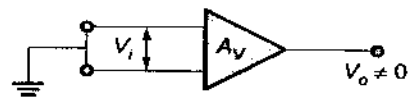

$V_o \neq 0 \rightarrow$ Called O/P offset voltage.

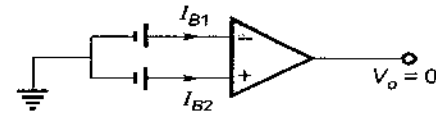

Balanced condition.

Input bias current (I_B)

$$I_B = \frac{I_{B1} + I_{B2}}{2}$$

Input offset current

$$I_{io} = (I_{B1} - I_{B2})$$

Note:

Input offset voltage is the voltage which must be applied between input terminals to balance amplifier ($V_o = 0$).

Linear Op-Amp Circuits

Inverting Amplifier

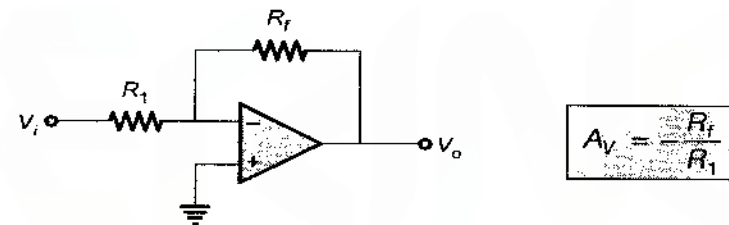

$$A_v = -\frac{R_f}{R_1}$$

Non-inverting Amplifier

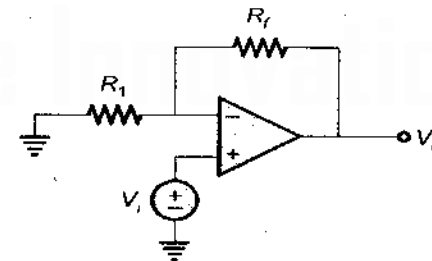

$$A_v = \left(1 + \frac{R_f}{R_1}\right)$$

Summing Amplifier

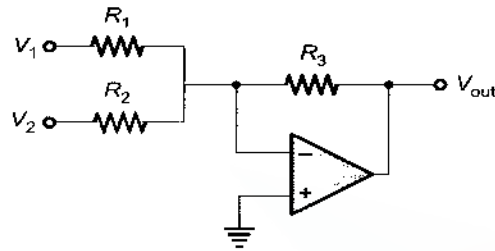

Output voltage

$$V_{out} = -\frac{R_3}{R_1} V_1 - \frac{R_3}{R_2} V_2$$

Differential Amplifier

$$V_0 = -\frac{R_2}{R_1} V_1 + \left(\frac{R_4}{R_3 + R_4} \right) \left(1 + \frac{R_2}{R_1} \right) V_2$$

if $\frac{R_2}{R_1} = \frac{R_4}{R_3}$

then, $V_0 = \frac{R_4}{R_3} [V_2 - V_1] = \frac{R_2}{R_1} (V_2 - V_1)$

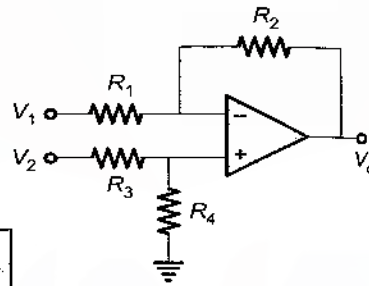

Note:

In this case when $\frac{R_2}{R_1} = \frac{R_4}{R_3}$,

$A_c = 0 \rightarrow$ Common mode gain and CMRR = ∞

Nonlinear Op-Amp circuits

Integrator

$$V_0 = -\frac{1}{RC} \int V_i dt + V_c(0+)$$

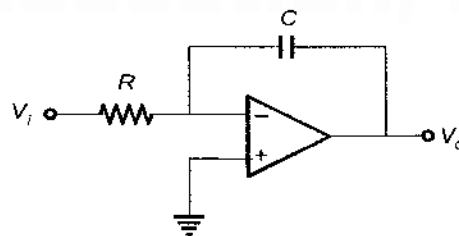

Differentiator

$$V_0 = -RC \frac{dV_i}{dt}$$

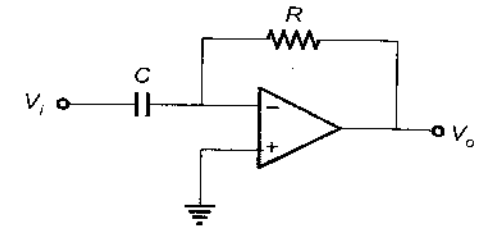

Logarithmic Amplifier

$$V_0 = -\eta V_T \ln \frac{V_i}{I_0 R}$$

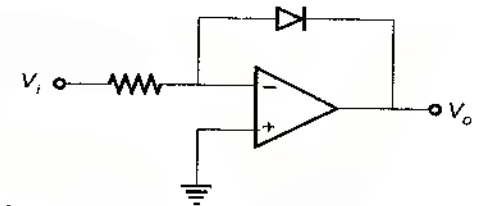

where, η = Recombination factor
 V_T = Thermal voltage
 I_0 = Reverse saturation current of diode

Antilog Amplifier

$$V_0 = -I_0 R \text{ antilog} \frac{V_i}{\eta V_T}$$

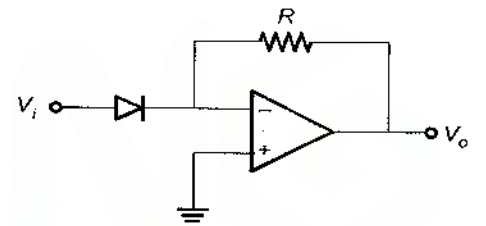

where, I_0 = Reverse saturation current of diode
 η = Recombination factor
 V_T = Thermal voltage

Schmitt Trigger

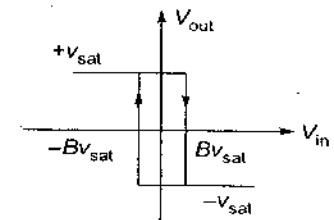
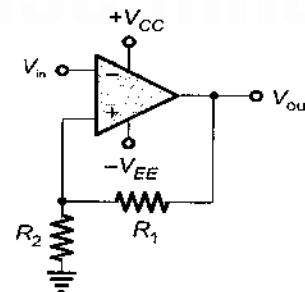

$$V_{Th} = \frac{R_1}{(R_1 + R_2)} V_H$$

$$V_{TL} = \frac{R_1}{(R_1 + R_2)} V_L \quad (\text{where } V_L \ll V_H)$$

Remember:

- The complete transfer characteristics of Schmitt trigger shows a hysteresis effect.
- The width of hysteresis is the difference between the two cross-over voltages V_{Th} and V_{TL} .

Op-Amp as a Multivibrator**Square Wave Generator or Astable Multivibrator**

Time period of output waveform generated is

$$T = 2RC \ln 3 \quad (\text{For } R_1 = R_2)$$

$$T = 2RC \ln \left[\frac{1+B}{1-B} \right] \quad \left(\text{where } B = \frac{R_2}{R_1 + R_2} \right)$$

Monostable Multivibrator

Width of pulse generated at output is

$$T = RC \ln \left(1 + \frac{R_2}{R_1} \right)$$

if $R_2 = R_1$,

then $T = RC \ln 2$

Note:

- Astable multivibrator is a square wave generator.
- Monostable multivibrator is used as pulse stretcher and missing pulse detector.

**Large Signal Amplifiers**

11

Load Line Analysis**For Common Emitter Amplifier**

where,

I_{CQ} = Quiescent collector current

V_{CEQ} = Quiescent collector-emitter voltage

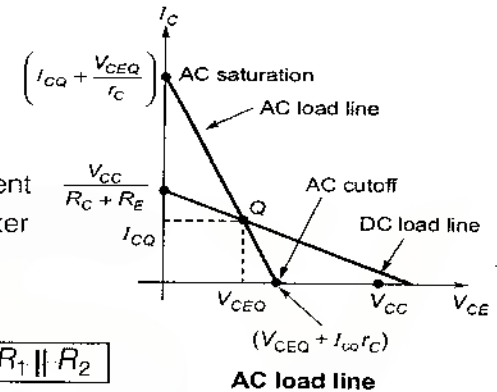
**Thevenin resistance driving base**

$$r_B = R_s \parallel R_1 \parallel R_2$$

AC load resistance seen by collector

$$r_C = R_C \parallel R_L$$

Equation of AC load line

$$I_C = I_{CQ} + \frac{V_{CEQ}}{r_C} - \frac{V_{CE}}{r_C}$$

where, I_{CQ} = DC collector current

V_{CEQ} = DC collector emitter voltage

r_C = AC resistance seen by collector

AC saturation current

$$I_{C(sat)} = I_{CQ} + \frac{V_{CEQ}}{r_C}$$

Note:

When the transistor goes into saturation, $V_{CE} = 0$.

AC cutoff voltage

$$V_{CE(cut)} = V_{CEQ} + I_{CQ} r_C$$

AC output compliance of a CE amplifier

$$PP \approx \min. (2I_{CQ} r_C, 2V_{CEQ})$$

Note:

AC output compliance is the maximum unclipped peak to peak ac voltage that an amplifier can produce.

For Emitter Follower Amplifier**Effective ac load resistance**

$$r_E = R_E \parallel R_L$$

AC saturation current

$$I_{C(sat)} = I_{CQ} + \frac{V_{CEQ}}{r_E}$$

AC cut-off voltage

$$V_{CE(cut)} = V_{CEQ} + I_{CQ}r_E$$

AC output compliance of an emitter follower

$$PP \cong \min. (2I_{CQ}r_E, 2V_{CEQ})$$

For Common Base Amplifier**AC load resistance of CB amplifier**

$$r_C = R_C \parallel R_L$$

Note:

AC load line and ac output compliance of CB amplifier are same as that of CE amplifier.

For Swamped Amplifier**AC saturation current**

$$I_{C(sat)} = I_{CQ} + \frac{V_{CEQ}}{r_C + r_E}$$

AC cut-off voltage

$$V_{CE(cut)} = V_{CEQ} + I_{CQ}(r_C + r_E)$$

AC output compliance of a swamped amplifier

$$PP \cong \min. \left(2I_{CQ}r_C, 2V_{CEQ} \frac{r_C}{r_C + r_E} \right)$$

For maximum AC output compliance

$$I_{CQ}r_C = V_{CEQ} \dots\dots (\text{CE stage})$$

$$I_{CQ}r_E = V_{CEQ} \dots\dots (\text{CC stage})$$

$$I_{CQ}r_C = V_{CEQ} \frac{r_C}{r_C + r_E} \dots\dots (\text{Swamped})$$

Power Amplifiers

It is a large signal amplifier which has greater AC output voltage and greater AC output current hence it can provide greater AC output power to load.

Conversion Efficiency

It is the ability of power amplifier to convert DC power into AC power:

$$\eta = \frac{P_{AC}}{P_{DC}} \times 100\%$$

Harmonic Distortion

The harmonic distortion means the presence of the frequency components in the waveform, which are not present in the input signal.

$$\text{If } I_C = I_0 + B_0 + B_1 \cos\omega t + B_2 \cos 2\omega t + \dots + B_n \cos n\omega t$$

$$\text{then } \% D_n = \frac{|B_n|}{|B_1|} \times 100\% \quad ; \quad \text{where, } n = 1, 2, 3, \text{ and so on}$$

Here, fundamental frequency component has an amplitude B_1 and n^{th} harmonic component has an amplitude of B_n .

Thus, total harmonic distortion is

$$\%D = \sqrt{D_2^2 + D_3^2 + D_4^2 + \dots + D_n^2} \times 100\%$$

Classification of Power Amplifier**Class-A Operation**

- Transistor operates in active region at all times.
- Collector current flows for 360° of the AC cycle.

Unloaded voltage gain of CE amplifier

$$A = - \frac{R_C}{r'_e}$$

Loaded voltage gain

$$A_v = -\frac{r_c}{r_e}$$

Current gain of the transistor

$$A_i = \frac{i_c}{i_b}$$

where, A_i = Current gain
 i_c = AC collector current
 i_b = AC base current

Note:

$A_i \equiv \beta$; In most of the circuits you can use the approximation.

Power gain

$$A_p = -A_v A_i$$

Load power

$$P_L = \frac{V_L^2}{R_L} = \frac{V_{PP}^2}{8R_L}$$

where, P_L = AC load power
 V_L = RMS load voltage
 V_{PP} = Peak-to-peak load voltage
 R_L = Load resistance

Transistor power Dissipation

$$P_{DQ} = V_{CEQ} I_{CQ}$$

where, P_{DQ} = Quiescent power dissipation
 V_{CEQ} = Quiescent collector-emitter voltage
 I_{CQ} = Quiescent collector current

Total DC power supplied to an amplifier

$$P_S = V_{CC} I_S$$

Maximum AC load power

$$P_{L(max)} = \frac{PP^2}{8R_L}$$

where, PP = Maximum unclipped value of V_{PP}

stage efficiency

$$\eta = \frac{P_{L(max)}}{P_S} \times 100\%$$

where, η = Stage efficiency
 P_S = DC input power

Remember:

- Class-A amplifier produces least distortion in the output among all power amplifier.
- Power drain is present.
- The maximum efficiency of class-A amplifier is 25%.

Class-B Operation

- Collector current flows for only 180° of the AC cycle.
- Q-point is located approximately at cutoff on both the DC and AC load lines.

Collector-emitter voltage at Q-point

$$V_{CEQ} = \frac{V_{CC}}{2}$$

AC load power of a class B push-pull amplifier

$$P_L = \frac{V_{PP}^2}{8R_L}$$

Remember:

- Output signal is half sinusoidal.
- Quiescent power dissipation/power drain is almost zero.
- The maximum efficiency of class-B amplifier is 78.5%.

Class AB Operation

- Operating point is located between the limits of class-A and class-B.
- Collector current flows for more than half sinusoidal but not fully sinusoidal.
- Distortion in class-AB amplifier is more than class-A but less than class-B.
- Power drain is more than class-B but less than class-A.

Class C Operation

- It is operated either in deep saturation or in deep cut-off region.
- The collector current flows for less than 90° of the AC cycle.

Tuned Amplifier

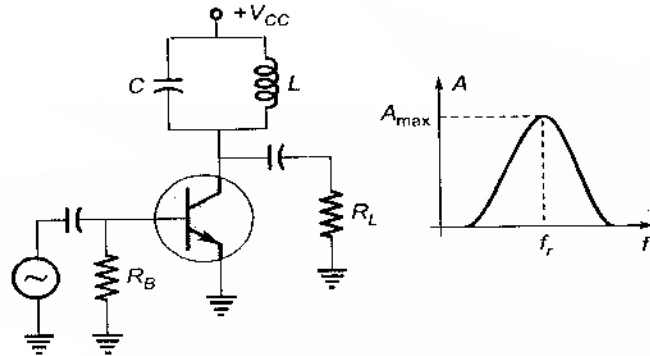

Resonant frequency of tank circuit

$$f_r = \frac{1}{2\pi\sqrt{LC}}$$

where, L = Inductance ; C = Capacitance

AC load power class C amplifier

$$P_L = \frac{V_{pp}^2}{8R_L}$$

Remember:

- It has highest conversion efficiency among all power amplifiers.
- Output is heavily distorted.
- It is used in tuned power amplifiers and radio frequency amplifier.
- The maximum efficiency of class-C amplifier is 87.5%.



The Signal Generators and Wave Shaping Circuits

Oscillators

The oscillators are positive feedback amplifier in which the part of output is feedback to the input via feedback circuit.

The gain, $\frac{V_o}{V_i} = \frac{A}{1 - A\beta}$

$\therefore V_i = 0$ (Noise)
 $A\beta = 1$ or $1 \angle 0^\circ \approx 1 \angle 360^\circ$

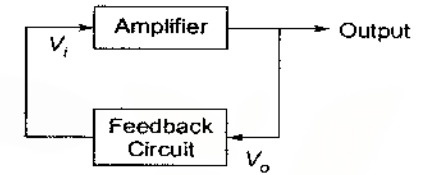

Barkhausen criterion

- The magnitude of loop gain $A\beta$ must be atleast 1.
- The total phase shift of the loop gain $A\beta$ must be equal to 0° or 360° .

Oscillator Types

Type of Component	Frequency of oscillation	Waveform generated
RC oscillator	Audio frequency	Sinusoidal
LC oscillator	Radio frequency	Square wave
Crystal oscillator	Radio frequency	Triangular wave sawtooth wave etc.

RC Phase Shift Oscillator

RC phase shift oscillator using BJT

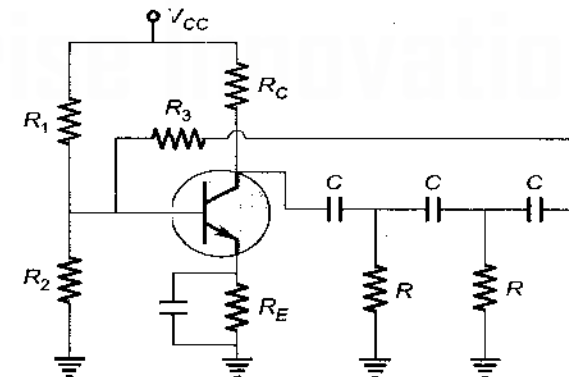

- Frequency of oscillation is

$$\omega = \frac{1}{RC\sqrt{4K+6}}$$

$$f = \frac{1}{2\pi RC\sqrt{4K+6}}$$

where,

$$K = \frac{R_C}{R}$$

Note:

- For transistor to work as oscillator

$$h_{fe} \geq \left(4K + 23 + \frac{29}{K}\right)$$

- $h_{fe(\min)} = 44.5$.

RC Phase Shift Oscillator using FET

- Frequency of Oscillation

$$f = \frac{1}{2\pi RC\sqrt{6}}$$

$$\beta = -\frac{1}{29} \text{ (feedback factor)}$$

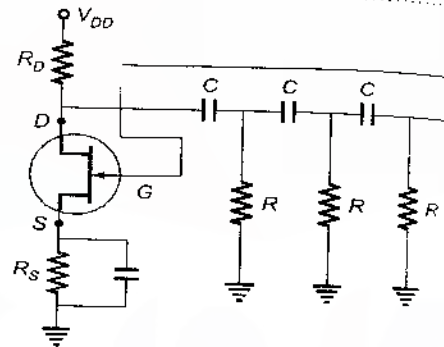

Note:

Amplification factor for FET to work as an Oscillator is $\mu \geq 29$.

RC Phase Shift Oscillator using Op-Amp

- Feedback factor

$$\beta = \frac{V_f}{V_o} = -\frac{1}{29} \text{ (for oscillation)}$$

- Frequency of oscillation

$$f = \frac{1}{2\pi RC\sqrt{6}}$$

Note:

$R_f \geq 29R_1 \rightarrow$ for oscillation.

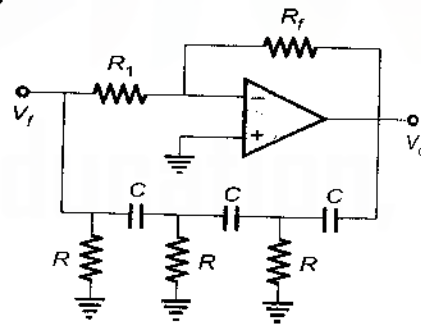

Wein Bridge Oscillator

- Frequency of oscillation

$$f = \frac{1}{2\pi\sqrt{R_3R_4C_1C_2}}$$

if $R_3 = R_4 = R$
and $C_1 = C_2 = C$

then

$$f = \frac{1}{2\pi R.C}$$

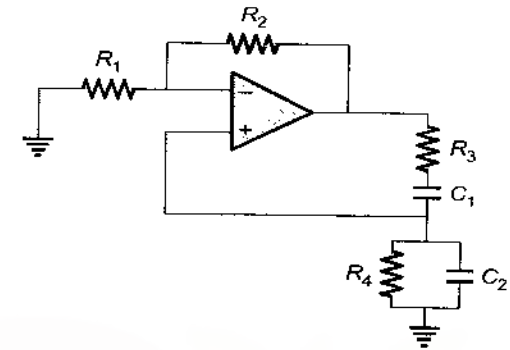

Remember:

- $\beta = \frac{1}{3}$ for oscillation.
- $R_2 \geq 2R_1$ for oscillation.

LC Oscillator

Colpitt's Oscillator

- Frequency of oscillation

$$f = \frac{1}{2\pi\sqrt{L\left(\frac{C_1C_2}{C_1+C_2}\right)}}$$

and

$$g_m R_C \geq \frac{C_2}{C_1}$$

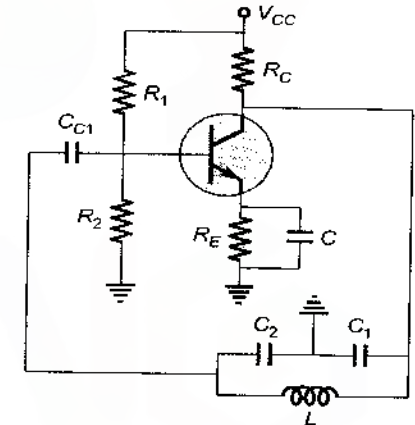

Hartley Oscillator

- If in place of C_1, C_2 there is L_1 and L_2 and in place of L there is C then it becomes Hartley Oscillator.

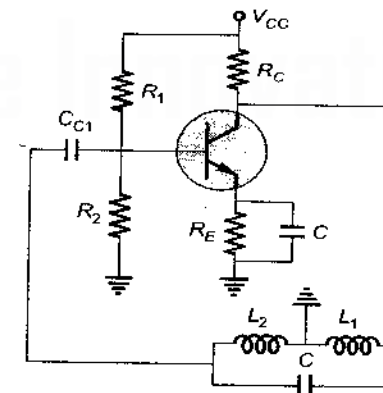

- Frequency of oscillation for Hartley Oscillator is

$$f = \frac{1}{2\pi\sqrt{C(L_1 + L_2)}} \quad \text{and} \quad g_m RC \geq \frac{L_1}{L_2}$$

Clapp Oscillator

- If in Colpitt oscillator circuit inductor is replaced by a variable capacitor (C_3) then frequency of oscillation becomes

$$f = \frac{1}{2\pi\sqrt{LC_3}} \quad \text{it happens if} \quad \left(\frac{C_1}{C} \gg 1\right) \quad \text{and} \quad \frac{C_1}{C} \gg \frac{C_1}{C_2}$$

Crystal Oscillator

- It is electrical equivalent circuit is
- Series resonance frequency

$$f_s = \frac{1}{2\pi\sqrt{LC}}$$

- Parallel resonance frequency

$$f_p = \frac{1}{2\pi\sqrt{LC_{eq}}} \quad \text{where,} \quad C_{eq} = \frac{CC_0}{(C + C_0)}$$

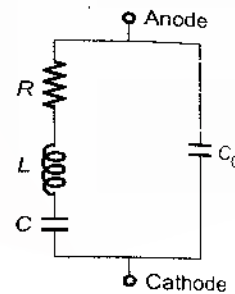

Note:

Frequency of oscillation is chosen between f_p and f_s .

Relaxation Oscillator

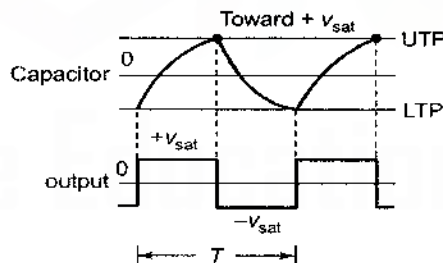
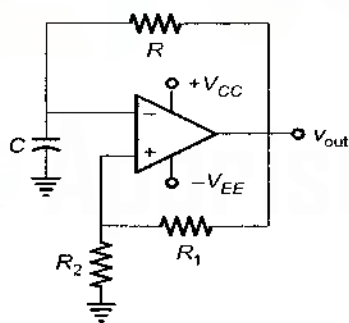

Time period of output signal

$$T = 2RC \ln\left(\frac{1+B}{1-B}\right)$$

where, R = Feedback resistance ; B = Feedback fraction

Note:

- Linear oscillator generates sinewaves utilizing resonance phenomenon.
- Non linear oscillators or function generators generate square-wave, triangular wave, pulses etc. waveforms. They use function blocks as multivibrators.
- Relaxation oscillator and UJT oscillator are non-linear oscillator.
- The oscillators which use a tunnel diode or UJT possess a current-voltage characteristic curve of negative slope within some range of operation are known as negative resistance oscillators.
- Wein's Bridge oscillator is a variable frequency oscillator.

Linear Wave Shaping Circuits

High Pass RC Circuit

Pulse response of high pass R.C circuit

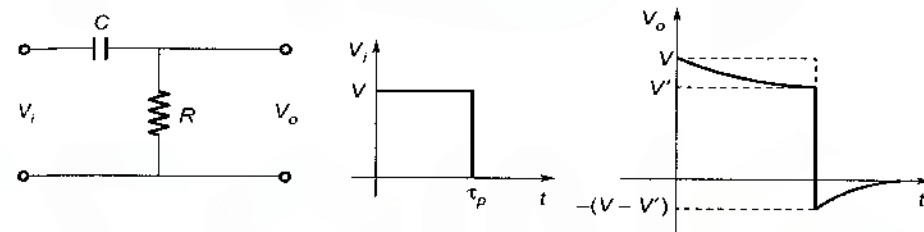

$(V - V')$ is called tilt or sag.

$$\% \text{ tilt} = \frac{V - V'}{V} \times 100\%$$

Note:

Sag or tilt will be obtained if $RC \gg \tau_p$.

- If input is a square wave of time period T then

$$\% \text{ tilt} = \frac{\pi f_L}{f} \times 100 \quad \text{where,} \quad f_L = \frac{1}{2\pi RC} \quad \text{and} \quad f = \frac{1}{T}$$

Low Pass RC Circuit

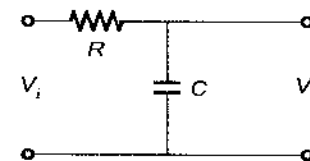

Rise time $t_r = \frac{0.35}{f_H}$ (rise from 10% to 90%)

where, $f_H = \frac{1}{2\pi RC}$

555 Timer

The 555 is a timing circuit that can produce accurate and highly stable time delays or oscillation.

555 Timer Pin Configuration

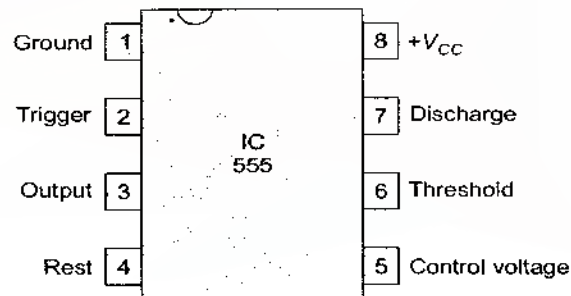

Monostable Multivibrator

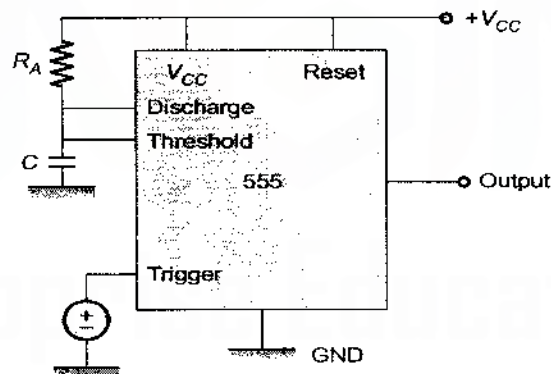

$T = RC \ln(3) = 1.1 RC$

Note:

The main applications of monostable multivibrator are pulse width modulator, linear ramp generator, frequency divider, pulse stretcher etc.

Astable Multivibrator

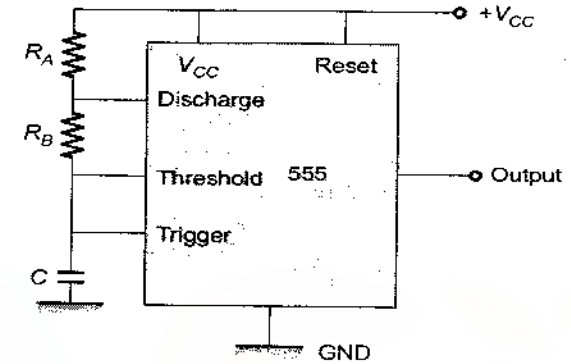

$T = \tau \ln(2)$

Charging time constant, $T_C = 0.693(R_A + R_B)C$

Discharging time constant, $T_D = 0.693 R_B C$

Total time, $T = T_C + T_D = 0.693 (R_A + 2R_B)C$

Duty cycle, $D = \frac{T_C}{T_C + T_D} \times 100\% = \frac{R_A + R_B}{R_A + 2R_B} \times 100\%$

Note:

The main applications of astable are square-wave generator, voltage control oscillator, FSK generator, free running oscillator etc.

Remember:

- Duty cycle (D) > 50%. (Because $T_C > T_D$)
- By placing a diode parallel to R_B and making $R_A + R_f = R_B$, we get square wave output of duty cycle 50%.



A Handbook on Electrical Engineering

9

Digital Electronics

CONTENTS

1. Number System and Codes	491
2. Logic Gates	495
3. Boolean Algebra and Reduction Techniques	504
4. Digital Logic Circuits	511
5. Sequential Circuits	519
6. Registers	525
7. Counters	527
8. Digital ICs Family	532
9. DACs and ADCs	542



Number System and Codes



Introduction

A digital system is a combination of devices designed to manipulate physical quantities or information that are represented in digital form, i.e. they can take on only discrete values. Examples of digital system are digital computer, calculator, telephone etc.

Advantages of Digital Techniques

1. Size and cost is less.
2. Power dissipation is less.
3. Digital circuits are less affected by noise.
4. Accuracy and precision are greater.
5. Information storage is easy.

Digital Number System

Many number systems are used in digital technology. The most common are the binary, octal, decimal and hexadecimal system.

Note:

A number system with base 'b' will have 'b' different digits from 0 to (b-1).

Number Representation

$$(N_b) = \underbrace{d_{n-1} d_{n-2} \dots d_1 \dots d_1 d_0}_{\text{Integral Portion}} \overset{\text{Radix point}}{\uparrow} \underbrace{d_{-1} d_{-2} \dots d_{-f} \dots d_{-m}}_{\text{Fraction Portion}}$$

where N = number

b = base or radix

- $d_{n-1} d_{n-2} \dots d_1 \dots d_1 d_0$ represents integral portion of number $(N)_b$, $d_{-1} d_{-2} \dots d_{-f} \dots d_{-m}$ represents fraction portion of number and between these two there is a radical sign.

Weighted number system

- It is a positional weightage system.
- Ex: Binary, octal, hexadecimal, BCD, 2421 etc.

Unweighted number system

- It is non positional weightage system.
- Ex: Gray code, Excess 3-code etc.

Number System	Base (b)	Digits
Binary	2	0, 1
Octal	8	0, 1, 2, 3, 4, 5, 6, 7
Decimal	10	0, 1, 2, 3, 4, 5, 6, 7, 8, 9
Hexadecimal	16	0, 1, 2, 3, 4, 5, 6, 7, 8, 9 A, B, C, D, E, F

- In binary number system, a group of "Four bits" is known as "Nibble" and group of "Eight bits" is known as "Byte".

Therefore,

4 bits = 1 Nibble
8 bits = 1 Byte

Decimal	Hexadecimal	Binary
0	0	0000
1	1	0001
2	2	0010
3	3	0011
4	4	0100
5	5	0101
6	6	0110
7	7	0111
8	8	1000
9	9	1001
10	A	1010
11	B	1011
12	C	1100
13	D	1101
14	E	1110
15	F	1111

Note:

- In positional weightage system, the position of each digit of a number has some positional weightage.
- In non-positional weightage system, a digit of a number does not indicate any significance in a position and weight.

Codes**Binary Coded Decimal Code (BCD)**

- Each digit of a decimal number is represented by binary equivalent.

In 4-bit binary formats

Total number of possible representation = $2^4 = 16$

Valid BCD codes = 10

Invalid BCD codes = 6

In 8-bit binary formats

Valid BCD codes = 100

Invalid BCD codes = $256 - 100 = 156$

Excess-3 code

- It is a 4-bit code.
- It can be derived from BCD code by adding "3" to each coded number.
- It is a "self-complementing code".

Gray code

- Also called "minimum change code" or "unit distance code" in which only one bit in the code group changes when going from one step to the next.
- Gray code is a minimum error code.

Binary-to-Gray conversion:

- 'MSB' in the gray code is same as corresponding digit in binary number.
- Starting from "Left to Right", add each adjacent pair of binary digits to get next and gray code digit. (Discard the carry if generated).

Gray-to-Binary conversion:

- "MSB" of Binary is same as that of gray code.
- Add each binary digit to the generated gray digit in the next adjacent position (discard the carry if generated).

Remember:

- In self-complemented code, the sum of weightage = 9.
- The largest number that can be represented by using N-bits is $(2^N - 1)_{10}$.

Conversion of Number System**(a) Decimal Number System to Other Number System Conversion**

To convert decimal to any other base 'r' divide integer part and multiply fractional part with 'r'.

(b) Other Number System to Decimal Number System Conversion

Any 'r' base number can be converted to decimal equivalent by multiplying each digit by its positional weightage and summing the products.

$$(x_2 x_1 x_0 \cdot y_1 y_2)_r \rightarrow ()_{10}$$

$$(x_2 \times r^2 + x_1 r^1 + x_0 r^0 + y_1 r^{-1} + y_2 r^{-2})_{10}$$

(c) Octal to Binary

Each digit is represented with 3 bit binary equivalent.

(d) Hexadecimal to Binary

Each digit is represented with 4 bit binary equivalent.

(e) Octal to Hexadecimal

- First convert octal to binary and then binary to Hexadecimal.
- From Hexadecimal to octal conversion first convert Hexadecimal to binary and then binary to octal number.

**Logic Gates****2****Introduction**

- Logic gates are most fundamental digital circuit that can be constructed from diodes, transistors and resistors connected in such a way that the circuit output is the result of a basic logic operation performed on the inputs.
- The Boolean '0' and '1' represents the "logic level".

Logic 0	Logic 1
False	True
OFF	ON
Low	High
No	Yes
Open switch	Closed switch.

- A "Truth table" is a means of describing how a logic circuits output depends on the logic levels present at circuits input.

Note:

The number of input combinations will equals to 2^N for an "N-input" truth table.

- The Logic Gates can be classified as
 - Basic Gate:** NOT, AND, OR.
 - Universal Gate:** NAND, NOR.
 - Special Purpose Gates:** EX-OR and EX-NOR. They are used in arithmetic circuit, comparators, code conversion, parity generators and parity checkers etc.

NOT Gate

It is also referred as "inversion" or "complementation".

Symbol and Truth Table

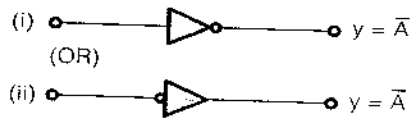

Input	Output
A	$y = \bar{A}$
0	1
1	0

Switching Circuit

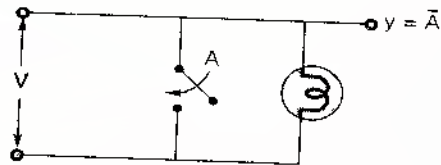

Transistor Circuit

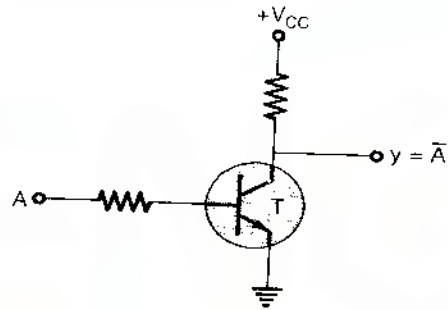

A	T	y
0	OFF	+V _{cc} = 1
1	0	Ground = 0

- When even number of NOT Gates are connected in series then it acts like Buffer Circuit.

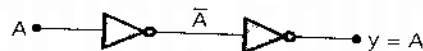

- When even number of NOT Gates are connected with feedback then it acts like a "Bistable multivibrator". It is also a basic memory element.

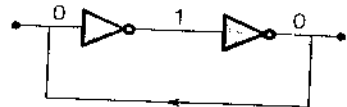

When odd number of NOT Gates are connected with feedback, then it acts like an astable multivibrator (AMV) or square-wave generator or clock generator or ring oscillator.

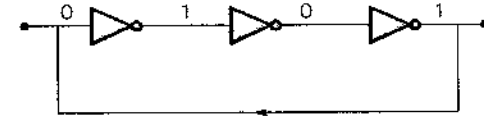

- All inverter take some time to get the response 'Y', this time is called propagation delay time (t_{pd}).

For an Astable Multivibrator (AMV)

Time period of Square Wave Generated by AMV:

$$T = 2nt_{pd}$$

where n = Number of inverters (NOT Gates)

t_{pd} = Propagation delay time of each inverter

T = Time period of a square wave generated by AMV or Ring oscillator

AND Gate

Symbol, Truth Table and Switching Circuit

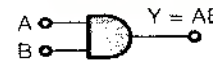

Inputs		Output
A	B	$Y = AB$
0	0	0
0	1	0
1	0	0
1	1	1

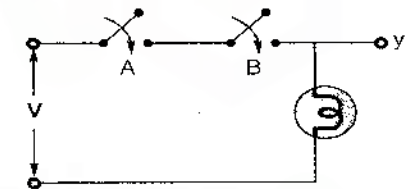

Note:

In AND operation

- ENABLE INPUT \Rightarrow Logic '1'
- DISABLE INPUT \Rightarrow Logic '0'

Transistor circuit:

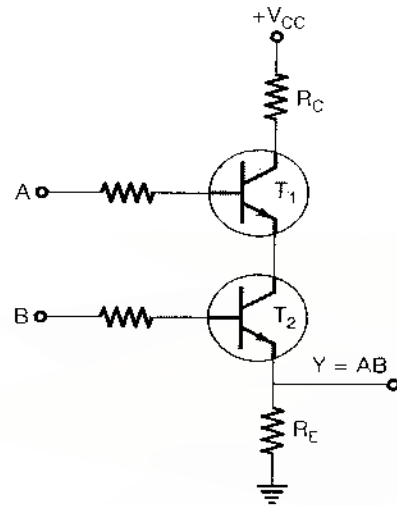

A	B	T ₁	T ₂	Y
0	0	OFF	OFF	0
0	1	OFF	ON	0
1	0	ON	OFF	0
1	1	ON	ON	1

Diode circuit diagram:

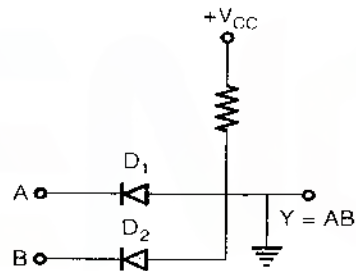

A	B	D ₁	D ₂	Y
0	0	ON	ON	0
0	1	ON	OFF	0
1	0	OFF	ON	0
1	1	OFF	OFF	1

Remember:

- In AND gate operation, any unused inputs (Floating inputs) may be connected as:
Logic '1' for TTL circuit
Logic '0' for ECL circuit
- AND gate is also known as detector logic

OR Gate

Symbol, Truth Table and Switching Circuit

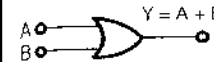

Inputs		Output
A	B	Y = A + B
0	0	0
0	1	1
1	0	1
1	1	1

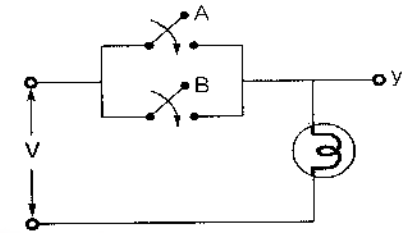

Remember:

In OR operation

- ENABLE INPUT ⇒ Logic '0'
- DISABLE INPUT ⇒ Logic '1'

Transistor Circuit

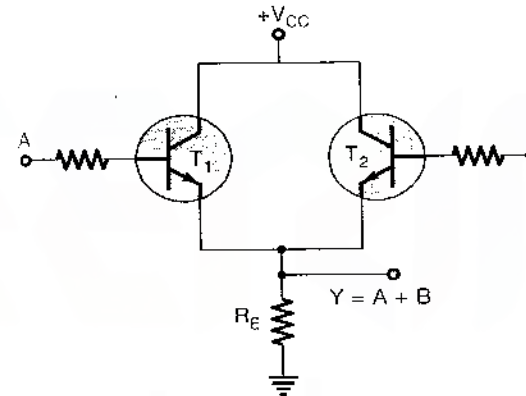

A	B	T ₁	T ₂	Y
0	0	OFF	OFF	0
0	1	OFF	ON	1
1	0	ON	OFF	1
1	1	ON	ON	1

Diode Circuit Diagram

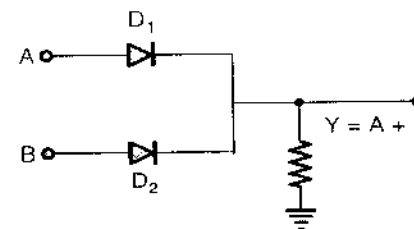

A	B	D ₁	D ₂	Y
0	0	ON	ON	1
0	1	ON	OFF	1
1	0	OFF	ON	1
1	1	OFF	OFF	0

NAND Gate

Symbol, Truth Table and Switching Circuit

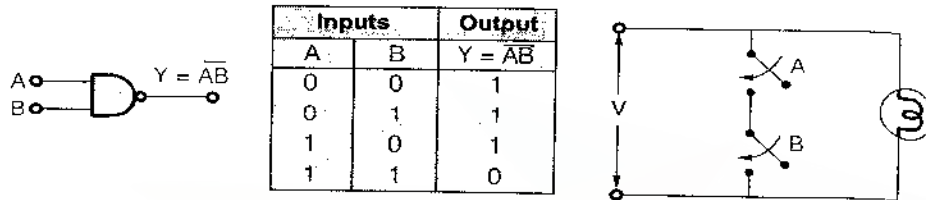

Remember:

In NAND operation

- ENABLE INPUT \Rightarrow Logic '1'
- DISABLE INPUT \Rightarrow Logic '0'

Transistor Circuit

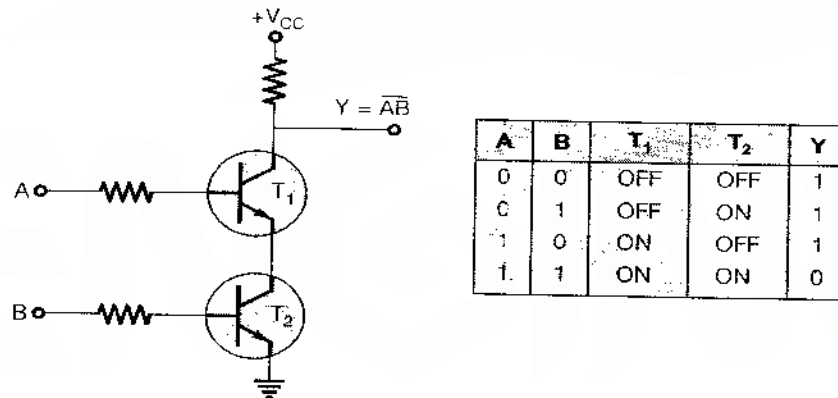

NOR Gate

Symbol, Truth Table and Switching Circuit

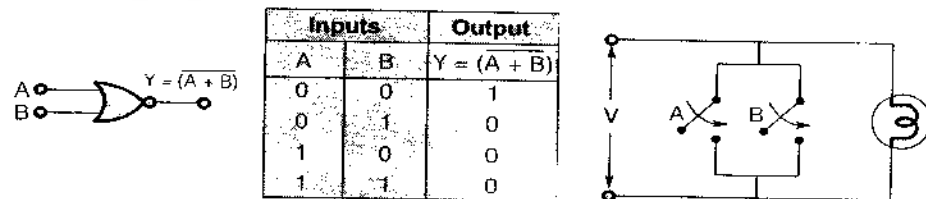

Remember:

In NOR operation

- ENABLE INPUT \Rightarrow Logic '0'
- DISABLE INPUT \Rightarrow Logic '1'

Transistor circuit

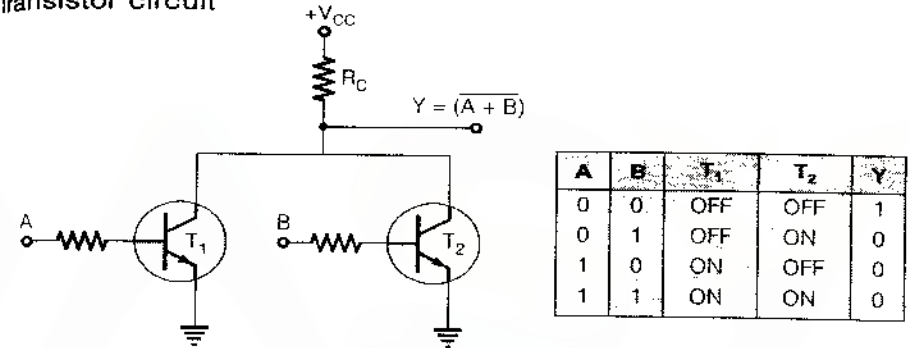

EXOR Gate

It is also called "stair case switch".

Symbol and Truth Table

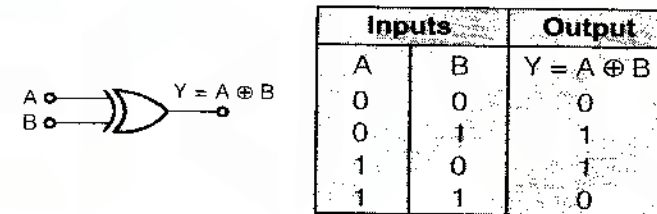

Boolean function of 2-input EXOR operation

$$Y = A \oplus B = \overline{A}B + A\overline{B}$$

Remember:

- It acts as "odd number of 1's detector in the input".
- It is mostly used in "parity generation and detection".
- When both the inputs are same, then output becomes LOW or Logic '0'.
- When both the inputs are different, then output becomes HIGH or Logic '1'.
- In EXOR operation
 - For BUFFER CIRCUIT \Rightarrow Logic '0'
 - For INVERSION CIRCUIT \Rightarrow Logic '1'

Note:

$$A \oplus A = 0, \quad A \oplus 0 = A$$

$$A \oplus \bar{A} = 1, \quad A \oplus 1 = \bar{A}$$

- $A \oplus A \oplus A \oplus \dots$ upto n terms = 0, when n = even
= A, when n = odd

EXNOR Gate

- It acts as "even number of 1's detector".
- It is also called "Gate of equivalence" or "coincidence logic".

Symbol and Truth Table

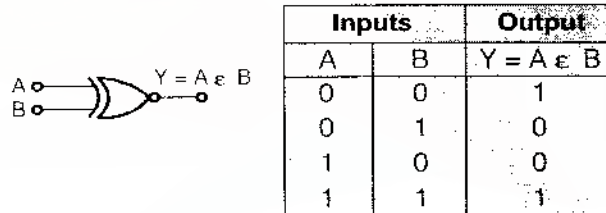

□ Boolean function of 2-input EXNOR operation

$$Y = A \odot B = \bar{A} \oplus \bar{B} = (\bar{A}B + A\bar{B}) = AB + \bar{A}\bar{B}$$

Remember:

- When both the inputs are same, then output becomes HIGH or Logic '1'.
- When both the inputs are different, then output becomes LOW or Logic '0'.
- In EXNOR operation
 - (i) For BUFFER CIRCUIT \Rightarrow Logic '1'
 - (ii) For INVERSION CIRCUIT \Rightarrow Logic '0'

Note:

$$A \odot A = 1, \quad A \odot 1 = A$$

$$A \odot \bar{A} = 0, \quad A \odot 0 = \bar{A}$$

- $A \odot A \odot A \odot \dots$ upto n terms = 1, when n = even
= A, when n = odd

$$\bar{A} \oplus B = A \odot B \text{ and } A \oplus \bar{B} = A \odot B$$

$$\bar{A} \odot B = A \oplus B \text{ and } A \odot \bar{B} = A \oplus B$$

Alternative Symbols of Gates

Bubbled – OR gate \equiv NAND gate



Bubbled – NAND gate \equiv OR gate

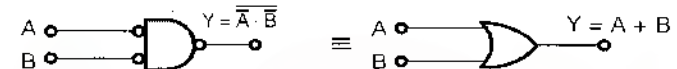

Bubble – NOR gate \equiv AND gate



Bubbled – AND gate \equiv NOR gate

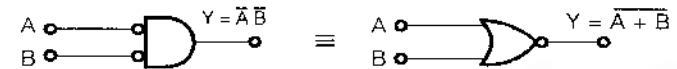

NAND and NOR Gate as Universal Gate

Logic gates	No. of NAND gate required	No. of NOR gate required
NOT	1	1
AND	2	3
OR	3	2
EX-OR	4	5
EX-NOR	5	4

Boolean Algebra and Reduction Techniques

3

De Morgan's Theorem

$$\overline{(A_1 \cdot A_2 \cdot A_3 \cdots A_n)} = \bar{A}_1 + \bar{A}_2 + \bar{A}_3 + \cdots + \bar{A}_n$$

$$\overline{(A_1 + A_2 + A_3 + \cdots + A_n)} = \bar{A}_1 \cdot \bar{A}_2 \cdot \bar{A}_3 \cdots \bar{A}_n$$

Transposition Theorem

$$(A + B)(A + C) = A + BC$$

Distribution Theorem

$$A + BC = (A + B)(A + C)$$

Consensus Theorem

- Used to eliminate redundant term.
- It is applicable only when if a boolean function,
 1. Contains 3-variables
 2. Each variable used 2-times
 3. Only one variable is in complemented or uncomplemented form.
 4. Then the related terms to that complemented or uncomplemented variable is the answer.

Ex: $AB + \bar{A}C + BC = AB + \bar{A}C$

Boolean Algebraic Theorems

Theorem No.	Theorem
1.	$(A + B) \cdot (A + \bar{B}) = A$
2.	$AB + \bar{A}C = (A + C)(\bar{A} + B)$
3.	$(A + B)(\bar{A} + C) = AC + \bar{A}B$
4.	$AB + \bar{A}C + BC = AB + \bar{A}C$
5.	$(A + B)(\bar{A} + C)(B + C) = (A + B)(\bar{A} + C)$
6.	$\overline{A \cdot B \cdot C \cdots} = \bar{A} + \bar{B} + \bar{C} + \cdots$
7.	$\overline{A + B + C + \cdots} = \bar{A} \cdot \bar{B} \cdot \bar{C} \cdots$

Duality Theorem

- "Dual expression" is equivalent to write a negative logic of the given boolean relation. For this we,

Boolean Algebraic Laws

Commutative Law

$$A + B = B + A \quad \text{and} \quad A \cdot B = B \cdot A$$

Associative Law

$$A + (B + C) = (A + B) + C = A + B + C$$

and

$$A \cdot (B \cdot C) = (A \cdot B) \cdot C = A \cdot B \cdot C$$

Distributive Law

$$A(B + C) = AB + AC$$

$$(A + B)(C + D) = AC + AD + BC + BD$$

Boolean Algebraic Theorems

AND-Operation Theorem

$$A \cdot A = A \quad A \cdot 0 = 0$$

$$A \cdot 1 = A \quad A \cdot \bar{A} = 0$$

Involution Theorem

$$\overline{(A')} = \bar{\bar{A}} = A$$

OR-Operation Theorem

$$A + A = A \quad A + 0 = A$$

$$A + 1 = 1 \quad A + \bar{A} = 1$$

1. Change each OR sign by an AND sign and vice-versa.
2. Complement any '0' or '1' appearing in expression.
3. Keep literals as it is.

Note:

- If a dual of an expression results the expression itself then it is called "self dual expression".
- For N-variables, maximum possible Self-Dual Function = $(2)^{2^n-1} = 2^{(2^n/2)}$.
- With N-variables, maximum possible distinct logic functions = 2^{2^n} .

Complementary Theorem

For obtaining complement expression we

1. Change each OR sign by AND sign and vice-versa.
2. Complement any '0' or '1' appearing in expression.
3. Complement the individual literals.

Boolean Function Representation**Canonical Form**

All the terms contains each literal.

$$\text{Ex.: } F(A,B,C) = \bar{A}BC + ABC + \bar{A}\bar{B}\bar{C}$$

Standard Form

All the term do not have each literals.

$$\text{Ex.: } F(A,B,C) = \bar{A} + BC + \bar{A}\bar{B}\bar{C}$$

Note:

A binary-variable is called "LITERALS".

Minterms and Maxterms

- n-binary variables have 2^n possible combinations and each of these possible combination is called "Minterm or Standard Product form".
- "Maxterm" is the complement of corresponding "Minterm" i.e.

$$M = \bar{m} ; \text{ with don't care conditions remain same.}$$

Reduction Techniques**SOP (Sum of Product)**

In SOP form each product term is known as min term. SOP form is used when output is logic 1.

$$\text{e.g. } \underbrace{ABC}_{\text{Min term}} + \bar{A}\bar{B}C + ABC$$

POS (Product of SUM)

In POS form each product term called as max term. POS form is used when output is 0 logic '0'.

$$\text{e.g. } \underbrace{(A+B+C)}_{\text{Max term}} + (A+\bar{B}+C) \cdot (\bar{A}+B+C)$$

Note:

- AND-OR Logic \equiv NAND-NAND Logic and is used in SOP.
- OR-AND Logic \equiv NOR-NOR Logic and is used in POS.

Dual

Dual expression is used to convert positive logic into negative logic or vice-versa.

Procedure

1. AND logic \longleftrightarrow OR
2. 1 \longleftrightarrow 0
3. Keep variable as it is.

Note:

- Two time dual results in same expression.
- Positive logic AND = Negative logic OR and vice-versa.

Complement

1. AND \longleftrightarrow OR
2. 1 \longleftrightarrow 0
3. Complement each variable.

Remember:

- With 'n' variables maximum possible logical expressions are 2^{2^n} .
- With 'n' variables maximum possible self dual expressions are $2^{2^{n-1}}$.

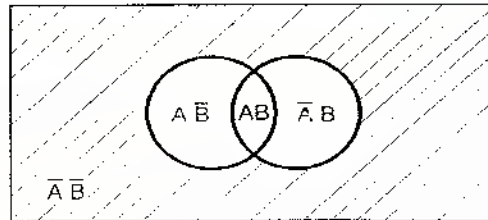
Venn Diagram

Here, the AND operation is considered as an intersection and the OR operation is considered as a union.

K-Map**Complete Simplification Rules (K-Map)**

- Construct the K-map and place 1's in the cells corresponding to the 1's in the truth table. Place 0's in the remaining cells.
- Examine the map for adjacent 1's and loop those 1's which are not adjacent to any other 1's. These are called isolated 1's.
- Next, look for those 1's which are adjacent to only one other 1. Loop any pair containing such a 1.
- Loop any octet even it contains some 1's that have already been looped.
- Loop any quad that contains one or more 1's which have not already been looped, making sure to use the minimum number of loops.
- Loop any pairs necessary to include any 1's that have not yet been looped, making sure to use the minimum number of loops.
- Form the OR sum of all the terms generated by each loop.
- In an n-variable Karnaugh-map there are 2^n cells.

Don't Care Condition

- Some logic circuit can be designed so that there are certain input condition for which there is no specified output levels, usually because these conditions will never occur.

- So, a circuit designer is free to make the output for any "don't care" condition either a '0' or '1' in order to produce the simplest output expression.

Implicant

Each individual min-term in canonical SOP form is called implicant.

Prime Implicant

Prime implicant is an implicant, which is obtained by combining maximum possible adjacent cell in K-map.

Essential Prime Implicant

An essential prime implicant is a prime implicant in which one or more min term are unique i.e. which is obtain by combining only one way in K-map.

Digital Number Representation

- In unsigned magnitude representation with 'n' bits, the possible integer values are $[0 - (2^n - 1)]$.
- Extra bit \rightarrow sign bit \rightarrow MSB
 - if MSB = 0 \rightarrow +ve number
 - if MSB = 1 \rightarrow -ve number
- In a sign magnitude representation the range of number.

$$-(2^{n-1} - 1) \text{ to } +(2^{n-1} - 1)$$

Compliment: For base 'r' $\left\{ \begin{array}{l} \rightarrow (r-1)\text{'s compliment} \\ \rightarrow r\text{'s compliment} \end{array} \right.$

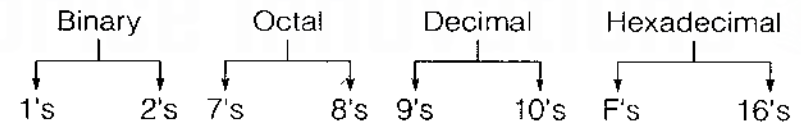

1. To determine $(r-1)$'s compliment, the given number is subtracted from the maximum possible number in given base.
2. To determine r 's compliment, first write $(r-1)$'s compliment then add 1 to the LSB (Least Significant Bit).

- In 1's complement representation, the positive number are represented similar to positive number in sign magnitude, but for representing negative number, first to write positive number and then take 1's complement of that.

□ Range of 1's complement number

$$-(2^{n-1} - 1) \text{ to } +(2^{n-1} - 1)$$

□ Range of 2's complement representation number

$$-2^{n-1} \text{ to } +(2^{n-1} - 1)$$

Binary Arithmetic

- When both number have same sign then we add only magnitudes and use the sign as MSB.

1's complement addition

- When the numbers have different sign, keep one number as it is and 1's complement the other then we add magnitude only.
- If carry is present
 - add carry to LSB
 - sign of the result is sign of the uncomplemented number.
- If carry is not present
 - take 1's complement the result.
 - sign of the result is sign of the complemented number.

2's complement addition

In 2's complement addition if any carry is present, then discard it.

Note:

- In 2's complement there is only one way to represent '0'.
- 2's complement of the 2's complemented number is equal to the number itself.
- In 2's complement representation to extend the number of bits MSB bit is always copied.



Digital Logic Circuits

4

Digital logic circuits are classified as:

- Combinational circuit
- Sequential circuit

Combinational Circuit	Sequential Circuit
1. Present output depends on present input only.	1. Present output depends on present input as well as previous output
2. No feedback is present.	2. Feedback is present.
3. No memory is present.	3. Due to feedback, memory is present
4. Example: Comparator, half adder, full adder, half subtractor, full-subtractor, multiplexer, demultiplexer, encoder, decoder.	4. Example: Flip-flop, counter, register.

Combinational Circuits

(a) Arithmetic Circuit

Half Adder (H.A)

A logic circuit for the addition of two one-bit numbers is referred to as an "HALF ADDER (H.A)".

Symbol and Truth table:

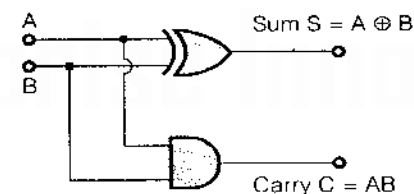

Inputs		Outputs	
A	B	Sum(S)	Carry(C)
0	0	0	0
0	1	1	0
1	0	1	0
1	1	0	1

Logical expression:

$$\text{Sum } S = A \cdot B + A \bar{B} = A \oplus B$$

$$\text{Carry } C = AB$$

Remember:

- Total number of NAND-gates required to implement half adder = 5
- Total number of NOR-gates required to implement half adder = 5
- To implement the half adder circuit by minimum number of logic gates (if we have all gates except EXOR and EXNOR) is "3".
- Total number of MUX required to implement half adder = 3.

Full Adder (F.A.)

It performs the arithmetic sum of the three input bits i.e. addend bit, augend bit and carry bit.

Logical expression:

$$\text{Sum, } S = A \oplus B \oplus C$$

$$\text{Carry, } C = AB + BC + CA = AB + C(A \oplus B)$$

Remember:

- A F.A. can be implemented by two H.A. and one OR-gate
- Total number of NAND-gate/NOR-gate required to implement a F.A is equals to "9".
- Total number of MUX required to implement full adder = 7.

Half Subtractor (H.S)

Logical expression:

$$\text{Difference, } D = \bar{A}B + A\bar{B} = A \oplus B$$

$$\text{Borrow, } B = \bar{A}B$$

Remember:

- Total number of NAND/NOR gates required to implement the H.S is equals to "5".
- Total number of MUX required to implement half subtractor = 3.

Full Subtractor (F.S)

It is a circuit which performs a subtraction between two bits taking into account that a '1' may have been borrowed by a lower significant stage.

Logical expression:

$$\text{Difference, } D = A \oplus B \oplus C$$

$$\text{Borrow, } B = \bar{A}B + \bar{A}C + BC = \bar{A}B + (A \oplus B) \cdot C$$

Remember:

- A full subtractor can be implemented with two half subtractor and one OR Gate.
- Number of NAND/NOR gates required to implement the full subtractor is equal to '9'
- In parallel adder n full adder or {(n-1) F.A. and 1 H.A.} or {(2n-1) H.A. and (n-1) or Gate} are required to add two n-bit numbers.
- Total number of MUX required to implement full subtractor = 7.

(b) Non Arithmetic Circuits**Multiplexer**

Multiplexer is a combinational circuit which have many data input and single output depending on select or control input, one of the input line is transfer to the output, hence it is known as "many to one circuit" or "universal logic circuit" or "data selector circuit".

- The selection of a particular input line is controlled by a set of select lines.
- There are 2^n input lines where 'n' is the number select line.

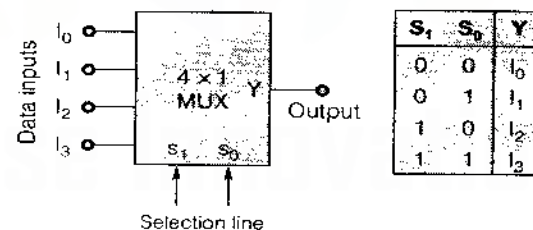
4 : 1 MUX

$$Y = \text{output} = \bar{S}_1 \bar{S}_0 I_0 + \bar{S}_1 S_0 I_1 + S_1 \bar{S}_0 I_2 + S_1 S_0 I_3$$

Note:

- The size of the MUX is specified by the 2^n of its input line and the single output line.
- MUX contains AND gate followed by an OR-gate.

2 : 1 MUX

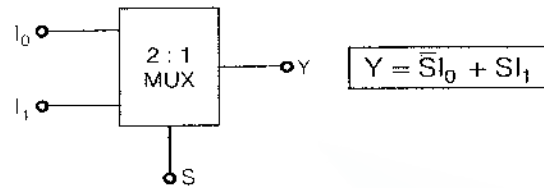

Higher order MUX using Lower order MUX:

Given MUX	To be Implemented MUX	Required number of MUX
2 : 1	4 : 1	3
4 : 1	16 : 1	4 + 1 = 5
4 : 1	64 : 1	16 + 4 + 1 = 21
8 : 1	64 : 1	8 + 1 = 9
8 : 1	256 : 1	32 + 4 + 1 = 37

Remember:

- To implement $2^n : 1$ MUX by using 2 : 1 MUX, the total number of 2 : 1 MUX required is $(2^n - 1)$.
- MUX is an Universal Logic gate.

Demultiplexer (DEMUX)

- It receives information on a single line and transmits it on one of 2^n possible output lines.
- A "Decoder" with an enable input can function as a "Demultiplexer".

1 : 2 Demux

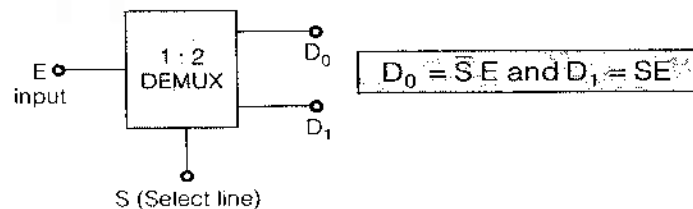

1 : 4 DEMUX

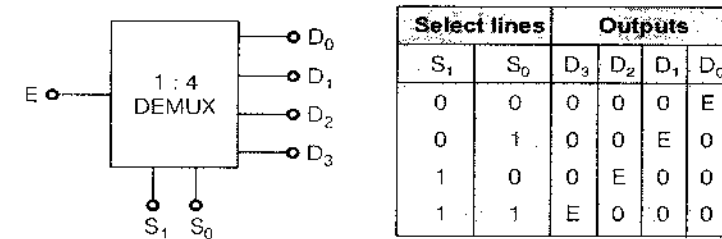

Select lines		Outputs			
S ₁	S ₀	D ₃	D ₂	D ₁	D ₀
0	0	0	0	0	E
0	1	0	0	E	0
1	0	0	E	0	0
1	1	E	0	0	0

$$D_0 = \bar{S}_1 \bar{S}_0 E, D_1 = \bar{S}_1 S_0 E, D_2 = S_1 \bar{S}_0 E, D_3 = S_1 S_0 E$$

Remember:

- Other name of demultiplexer are "one to many circuit" or "data distributor circuit".
- Number of select line is $\log_2 n$ (where n is number of output line).

Higher Order DEMUX Using Lower Order DEMUX:

Given DEMUX	To be Implemented MUX	Required number of MUX
1 : 2	1 : 4	1 + 2 = 3
1 : 2	1 : 8	1 + 2 + 4 = 7
1 : 2	1 : 16	1 + 2 + 4 + 8 = 15
1 : 2	1 : 64	1 + 2 + 4 + 8 + 16 + 32 = 63
1 : 4	1 : 16	1 + 4 = 5

Decoder

- Decoder is a combinational circuit that is use to convert binary to other codes such as
 - Binary to octal
 - Binary to decimal
 - Binary to hexadecimal
- In decoder, depending on binary data applied, one of the output line will become logic 1.
- A "Decoder" has many inputs and many outputs line.
- It is a combinational circuit that converts binary information from n input lines to a maximum 2^n unique output lines.
- If the n-bit decoded information has unused or don't care combinations, the decoder output will have less than 2^n outputs.

Total number of output lines

$$m \leq 2^n$$

where n = Total number of input lines

2 x 4 Decoder

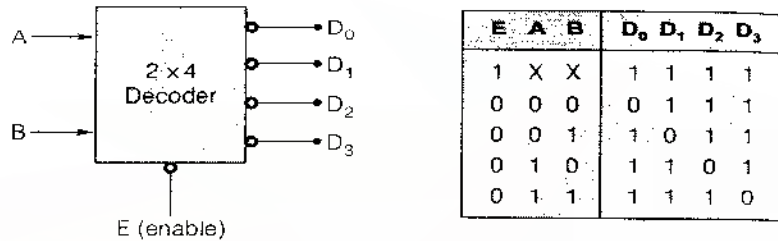

Note:

- 2 x 4 - Decoder may acts like 1 : 4 DE MUX and Vice-versa.
- Decoder and Demux circuits are almost same.
- Decoder contains AND-gates or NAND-gates.

Higher Order Decoder Using Lower Order Decoder:

Given Decoder	To be Implemented Decoder	Required number of Decoder
2 : 4	4 : 16	1 + 4 = 5
2 : 4	3 : 8	2 + a NOT Gate
4 : 16	8 : 256	1 + 16 = 17

Encoder

- Encoder is used to convert other codes to binary such as
 - Octal to binary
 - Hexadecimal to binary
 - Decimal to binary
 - Decimal to BCD
- In encoder one of the input line is high and corresponding binary is available at the output.
- In priority encoder any number of inputs can be high but based on priority highest priority input corresponding binary is available at the output.

Code Converters

BCD to Excess-3 code

- Let input variables of BCD code is A, B, C, D and output variables of excess-3 is W, X, Y, Z.
- Required truth table: (BCD + 0011 = excess-3-code)

Inputs (BCD)				Output (Excess-3 code)			
A	B	C	D	W	X	Y	Z
0	0	0	0	0	0	1	1
0	0	0	1	0	1	0	0
0	0	1	0	0	1	0	1
0	0	1	1	0	1	1	0
0	1	0	0	0	1	1	1
0	1	0	1	1	0	0	0
0	1	1	0	1	0	0	1
0	1	1	1	1	0	1	0
1	0	0	0	1	0	1	1
1	0	0	1	1	1	0	0

Minimized Boolean function:

$$Z = \bar{D}$$

$$Y = CD + C\bar{D}$$

$$X = \bar{B}C + \bar{B}D + B\bar{C}D$$

$$W = A + BC + BD$$

Binary-to Gray Code Converter

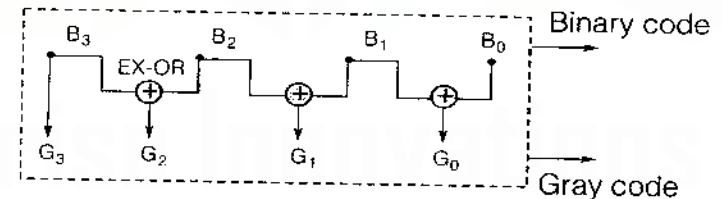

Equivalent logical gate diagram:

$$G_3 = B_3$$

$$G_2 = B_3 \oplus B_2$$

$$G_1 = B_2 \oplus B_1$$

$$G_0 = B_1 \oplus B_0$$

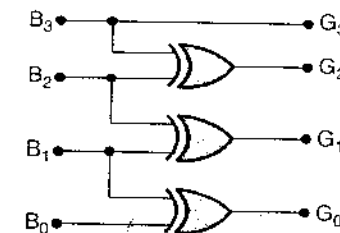

Gray to Binary Converter

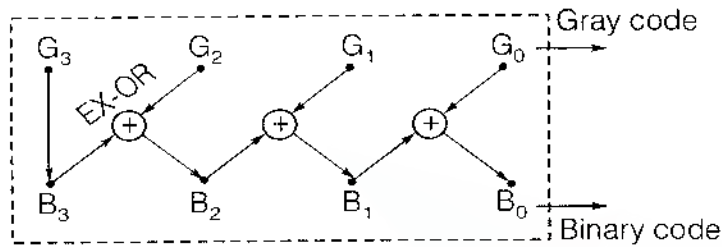

Equivalent Logical Gate Diagram:

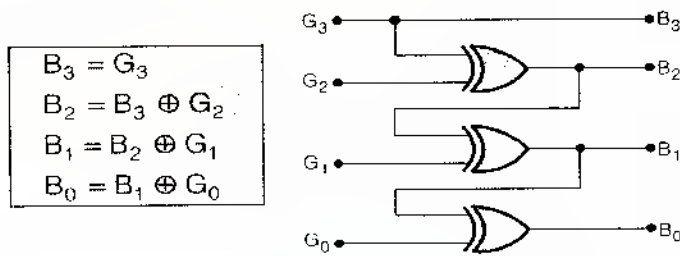

Magnitude Comparator

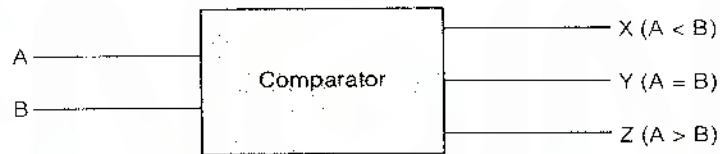

Truth table:

A	B	X	Y	Z
0	0	0	1	0
0	1	1	0	0
1	0	0	0	1
1	1	0	1	0
Output expression		$\bar{A}B$	$AB + \bar{A}\bar{B} = A \oplus B$	$A\bar{B}$



5

Sequential Circuits

flip-Flops

- Flip-flop is a basic memory element.
- It can store "one bit of information".
- A flip-flop has 2 outputs, which are always complementary to each other.
- A flip-flop has 2 stable state hence it is known as bi-stable multivibrator.
- A simplest form of flip-flop is called "latch". It can be constructed with two cross coupled NAND gates or NOR gates.

Triggering

- Triggering is used to initiate the operation of latches or flip-flops.
- Level trigger:** Input signal affects the flip-flop only when the clock is at logic '1' or logic '0'.
 - Edge trigger:** Input signal affects the flip-flop only if they are present at the positive or negative going edge of the clock pulse.

Setup Time

It is minimum time required to keep input at proper level before applying clock.

Hold Time

Hold time is minimum time required to keep input at same level after applying clock.

Note:

- If set-up time and hold time is not properly given, the output may go to meta stable state.

Clocked S-R Flip-Flop

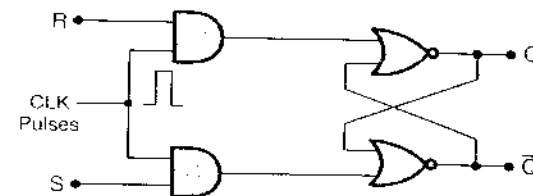

Truth table

Clock	S_n	R_n	Q_{n+1}
0	X	X	Q_n
1	0	0	Q_n
1	0	1	0
1	1	0	1
1	1	1	Invalid

→ HOLD state
 → RESET state
 → SET state
 → FORBIDDEN state

- S_n and R_n denotes the inputs and Q_n the output during the bit time 'n'.
- ' Q_{n+1} ' denotes the output Q after CLK passes, i.e. in bit time (n + 1).

Characteristic table

S	R	Q_n	Q_{n+1}
0	0	0	0
0	0	1	1
0	1	0	0
0	1	1	0
1	0	0	1
1	0	1	1
1	1	0	X
1	1	1	X

→ Q_n
 → 0
 → 1
 → Invalid

Characteristics equation

$$Q_{n+1} = S + RQ_n$$

Remember:

Disadvantage of SR flip-flop is invalid state will present when both inputs are 1 or high. To avoid this J-K flip-flop is used.

J-K Flip-Flop

JK-FF is called an universal FF because the FFs like D-FFs, SR-FF and T-FF can be derived from it.

$$S = J\bar{Q} \text{ and } R = KQ$$

Logic diagram

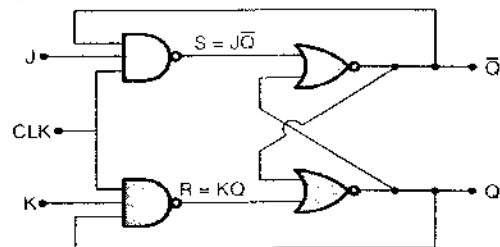

Truth table

Clock	J	K	Q_{n+1}
0	X	X	Q_n
1	0	0	Q_n
1	0	1	0
1	1	0	1
1	1	1	Q_n

→ HOLD state
 → RESET state
 → SET state
 → TOGGLE state

Characteristic table

J	K	Q_n	Q_{n+1}
0	0	0	0
0	0	1	1
0	1	0	0
0	1	1	0
1	0	0	1
1	0	1	1
1	1	0	1
1	1	1	0

→ Q_n
 → 0
 → 1
 → \bar{Q}_n

Characteristic equation

$$Q_{n+1} = J\bar{Q}_n + KQ_n$$

Race Around Condition

- The Race around condition will occur when
 - $J = K = 1$
 - $t_{pd(FF)} < t_{pw}$
 - Flip-flop is level triggered.
- For the duration " t_{pw} " of the clock pulse, the output Q will oscillate back and forth between 0 and 1. At the end of the clock pulse, the value "Q" is uncertain. This situation is referred as "race around condition".
- To avoid this, we should maintained

$$t_{pw} < t_{pd(FF)} < T$$

Remember:

Race around condition does not occur in edge triggered flip-flop.

Master-Slave J-K Flip-Flop

To avoid race around condition master slave FF is used.

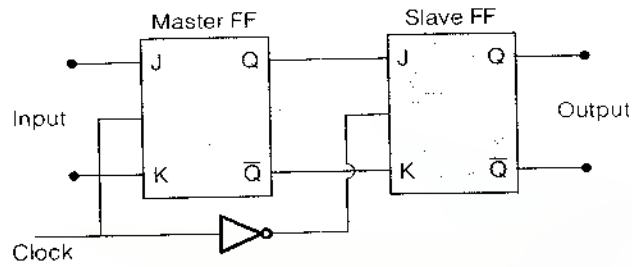

- In master slave flip-flop master is applied with input clock and slave is applied with inverted clock. Due to this when master output is changing slave output remains in previous state.
- In master slave flip-flop, output will change only when slave output change.
- Output of master can change many times but, slave output can change only 1 time so master FF act as level trigger and slave FF act as edge trigger. Therefore there is no "race around condition" at the output of the slave.

D-Flip-Flop

It is a FF with a delay equal to exactly one cycle of CLK.

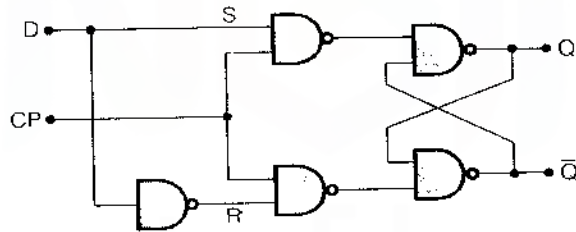

Graphical diagram

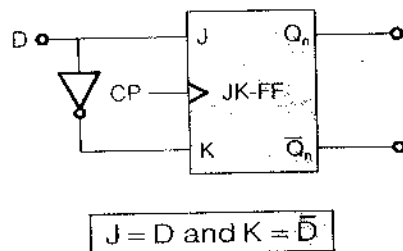

Truth table and characteristic table

CLK	D	Q_{n+1}
0	X	Q_n
1	0	0
1	1	1

Truth Table

D	Q_n	Q_{n+1}
0	0	0
0	1	0
1	0	1
1	1	1

Characteristic Table

Characteristic equation

$$Q_{n+1} = D$$

Note:

It is also known as "Transparent Latch" because $Q_{n+1} = D$.

Toggle Flip-Flop (T-FF)

- The T-FF is a single input version of the J-K FF.
- T-FF can be obtained from a J-K FF if J and K tied together as in figure shown below.
- The designation 'T', comes from the ability of the FF to "toggle" or "change state".

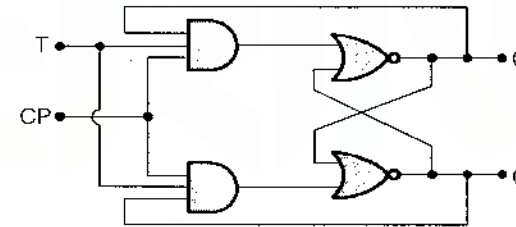

Graphical symbol of T-FF

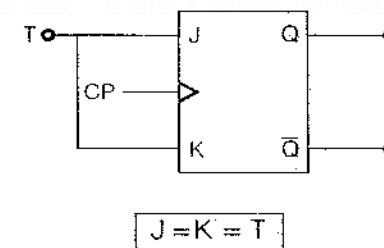



Registers

Truth table and characteristic table

CLK	T	Q_{n+1}
0	X	Q_n
1	0	Q_n
1	1	\bar{Q}_n

→ HOLD state
→ Toggle state

T	Q_n	Q_{n+1}
0	0	0
0	1	1
1	0	1
1	1	0

Truth Table

Characteristic Table

Characteristic equation

$$Q_{n+1} = \bar{T}Q_n + T\bar{Q}_n = T \oplus Q_n$$

Conversion of Flip-Flops

SR FF to other FFs	JK FF to other FFs	D-FF to other FFs	T-FF to other FFs
$S = J\bar{Q}_n$ & $R = KQ_n$	$J = S$ & $K = R$	$D = S + \bar{R}Q_n$	$T = S\bar{Q}_n + RQ_n$
$S = D$ & $R = \bar{D}$	$J = D$ & $K = \bar{D}$	$D = J\bar{Q}_n + \bar{K}Q_n$	$T = J\bar{Q}_n + KQ_n$
$S = T\bar{Q}_n$ & $R = TQ_n$	$J = K = T$	$D = T \oplus Q_n$	$T = D \oplus Q_n$

Excitation Table of Flip-Flops

Q_n	Q_{n+1}	S	R	J	K	D	T
0	0	0	X	0	X	0	0
0	1	1	0	1	X	1	1
1	0	0	1	X	1	0	1
1	1	X	0	X	0	1	0



Shift Registers (SRs)

- Registers are used to store group of bits.
- In register to store N-bit, it requires N flip-flop.
- In shift register each CLK pulse shifts the contents of register one-bit position to the RIGHT or LEFT.
- The "serial input" determines what goes into the left most FF during the shift.
- Depending upon input and output registers can be classified into 4 types.:
 - (a) SISO: Serial In Serial Out
 - (b) SIPO: Serial In Parallel Out
 - (c) PISO: Parallel In Serial Out
 - (d) PIPO: Parallel In Parallel Out

SISO (Serial In Serial Out)

4-bit Right-Shift SISO Register

- In right shift SISO register, LSB data is applied at the MSB FF'(D-FF).
- In 'n' bit register, to enter 'n' bit data, it requires 'n' clock pulses in serial form.
- If 'n' bit data is stored in SISO register then output is taken serially for this it required (n - 1) clock pulse.
- SISO register is used to provide 'n' clock pulse delay to the input data.
- If 'T' is the time period of clock pulse, then delay provided by SISO is nT.

4-bit Left-Shift SISO Register

- In this above SISO register MSB data is applied to the LSB FF(D-FF).
- To enter the 'n' bit data in serial form we required 'n' clock pulse.
- To exit or getting output of 'n' bit data as serially we required (n - 1) clock pulse.

SIPO (Serial In Parallel Out)

- For 'n' bit- serial input data to be stored the number of CLK pulse required = n.
- For 'n' bit-parallel output data to be stored the number of CLK pulse required = 0 (there is no need of CLK pulse).

PISO (Parallel In Serial Out)

- To store parallel in data, if we store 'n' bit then the number of CLK pulse required = 1 CLK pulse.
- To store serial out data if we store 'n' bit then the number of CLK pulse required = (n - 1).

Note:

To convert temporal code into spacial code, we use SIPO register. Where as to convert spacial code into temporal code we use PISO register.

PIPO (Parallel In Parallel Out)

- For parallel in data, the number of CLK pulse required = 1 CLK pulse.
- For parallel out data, the number of CLK pulse required = 0 CLK pulse.

Remember:

- All SRs are JK-FFs.
- "PIPO" register is a storage register made up with D-FFs.
- "PIPO" register is not a SR.
- A universal register can perform
 - Shift left/Shift right
 - Parallel in/Serial in
 - Parallel out/Serial out in a single register.
- If 'n' shift left operation perform then data will be multiply by 2^n times.
- If 'n' shift right operation perform then data will be divided by 2^n times.

Time delay

A SISO SRs may be used to introduce time delay " Δt " in digital signals

$$\Delta t = N \times T = N \times \frac{1}{f_c}$$

where, N = Number of FFs

T = Time period of CLK pulse

f_c = CLK frequency

- The amount of delay can be controlled by the " f_c " or number of FFs in the SR.

Note:

In terms of Speed: PIPO > PISO > SIPO > SISO

**Counters**

7

Introduction

- It is a sequential circuit forming by the cascading of FFs.
- Counter are basically used for
 - Counting of the number of clock pulses applied
 - Frequency division
 - Timers
 - Frequency measurement
 - Waveform generation
- Counters are classified as:
 - Asynchronous counter
 - Synchronous counter

Remember:

- If N = total number of states and 'n' = number of FFs then

$$N \leq 2^n$$

$$n \geq 3.32 \log_{10} N \quad \text{or} \quad n \geq \log_2 N$$

- If $N = 2^n$, then we get BINARY COUNTER.
- If $N < 2^n$, then we get NON-BINARY COUNTER.

MOD number

- The "MOD-number" indicates the number of states in counting sequence.
- For n-FFs, counter will have 2^n different states and then this Counter is said to be "MOD- 2^n Counter".
- MOD number indicates the frequency division factor obtained from the Last FF.
- It would be capable of counting upto $(2^n - 1)$ before returning to zero state.

Note:

- In "MOD-N Counter", if applied input frequency is "f", then output frequency is f/N.
- If two counters are cascaded with MOD-M followed by MOD-N, then number of overall states of combined counter is (M × N) and counter is called "MOD-MN" counter.

Asynchronous (Series) Counter

Binary Ripple Counter

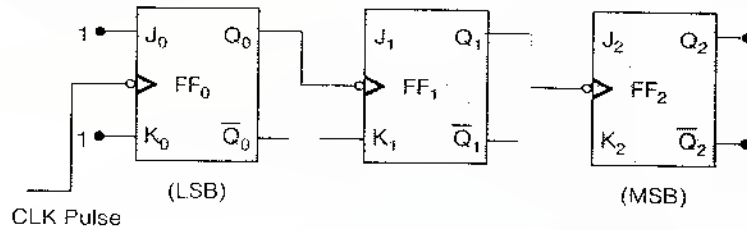

- In ripple counter with n-FFs there are 2ⁿ possible states.
- With n-FFs the maximum count that can be counted by this counter is (2ⁿ - 1).
- If input frequency is 'f' then output frequency is $\frac{f}{2^n}$.
- It is also known as 2ⁿ : 1 scalar divider.

For proper operation of the ripple counter:

$$T_{CLK} \geq n t_{pd(FF)}$$

$$f_{CLK} \leq \frac{1}{n t_{pd(FF)}}$$

Maximum CLK frequency:

$$f_{CLK,m} = \frac{1}{n t_{pd(FF)}}$$

Disadvantage of Ripple Counter:

Decoding error is present due to propagation delay of FFs i.e. $t_{pd(FF)}$.

Up/Down Counter

An "Up/Down Counter" can count in any direction depending upon the control input.

For determination of Up/Down Counter:

Triggering with	CLK connection in	Access as
(-ve) edge	Q	UP Counter
(-ve) edge	\bar{Q}	Down Counter
(+ve) edge	Q	Down Counter
(+ve) edge	\bar{Q}	UP Counter

Non-Binary Ripple Counter

Decade Counter or Mod-10 Counter

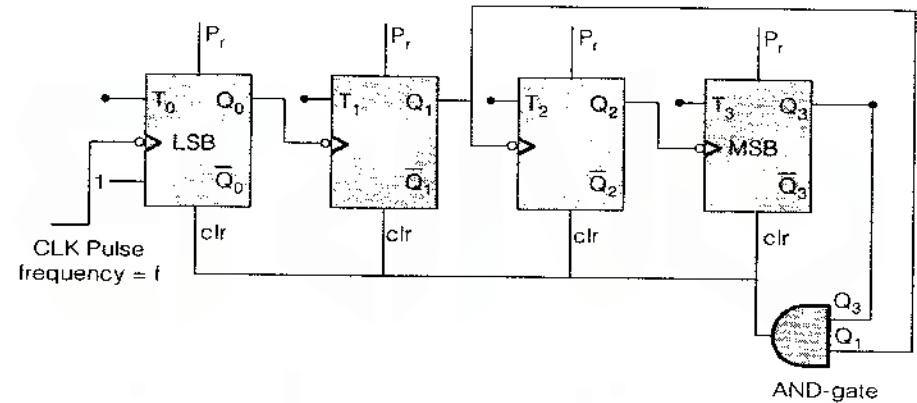

- Used states = 10 and unused states = 6
- For down counter, Mod Number = 2ⁿ - N.
- Output frequency of MOD-10 counter = f/10.
- Clear and preset is used in non binary ripple counter.
- Clear is used to reset counter without clock.
- Preset is used to set counter.
- When decade counter counts from 0 to 9 then it is known as BCD counter.

Synchronous (Parallel) Counters

Ring Counter

It is SISO shift register.

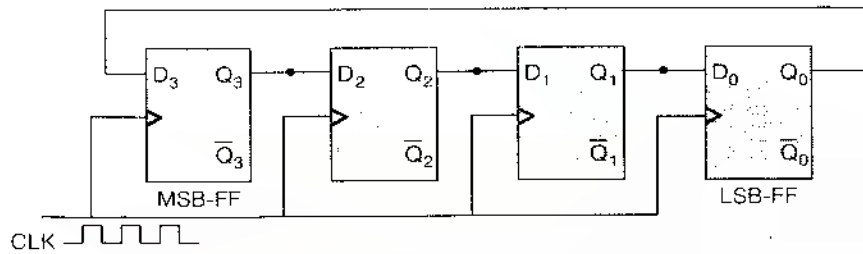

Remember:

- Ring counter is a non-self starting counter.
- With 'n' FFs, there are n-states present in ring counter.
- With 'n' FFs, maximum count possible in ring counter is $(2^n - 1)$.
- Decoding is very easy in Ring counter, because there is no aid of extra circuit.

In a 4-bit ring counter :

Used states = 4
 Unused states = $2^4 - 4 = 12$

- In a ring counter if CLK frequency is "f" the FFs output frequency is "f/N" (where N = Number of states = modulus of the counter).

Twisted-Ring Counter

Also known as Johnson Counter or Switch Tail Ring Counter

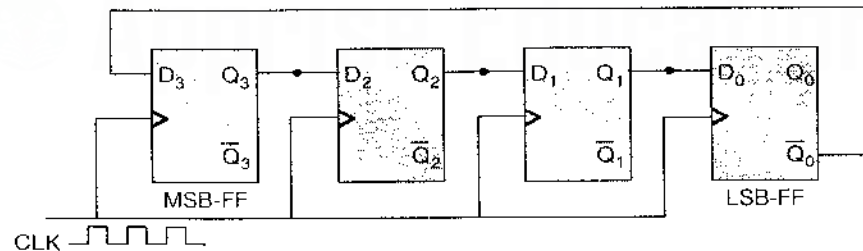

Remember:

- With 'n' FFs there are '2n' states in this counter.
- With 'n' FFs the maximum count by this counter is $(2^n - 1)$.
- In normal "Johnson Counter" with 'n' FFs and the input frequency is 'f' then output frequency of FFs is "f/2n"
- In a "Counter" if a feedback connection is used the number of possible states will decrease.

Synchronous-Series Carry Counter

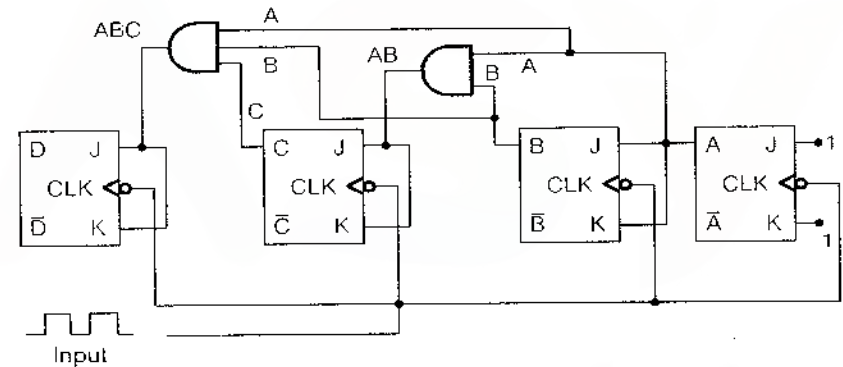

□ Clock frequency

$$f_{CLK} = \frac{1}{t_{pd(FF)} + (n - 2) t_{pd(AND\ gate)}}$$

Remember:

- Total delay of this counter is much lower than an asynchronous counter with same number of FFs.

$$\text{total delay} = FF t_{pd(FF)} + t_{pd(AND\ gate)}$$

Synchronous-Parallel Carry Counter

It is the "Fastest Counter".

Clock frequency:

$$f_{CLK} = \frac{1}{t_{pd(FF)} + t_{pd(AND\ gate)}}$$



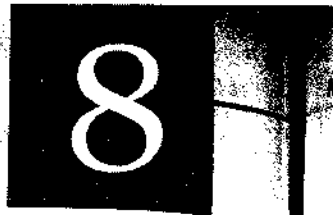

A group of compatible ICs with the same logic levels and supply voltages for performing various logic functions have been fabricated using a specific circuit configuration, is called "logic family".

Characteristics of Logic Families

1. Propagation Time Delay (t_{pd})

This is the average transition delay time for the signal to propagate from input to output when signal changes its value. This determines how fast the logic system can operate.

Delay time:

$$t_{pd} = \frac{t_{PHL} + t_{PLH}}{2} \text{ ns}$$

where t_{PLH} = Delay time in going from LOW logic to HIGH logic
 t_{PHL} = Delay time in going from HIGH logic to LOW logic

Remember:

- The delay times are measured between the 50% points on the input and output transitions.
- In BJT, $t_{PLH} > t_{PHL}$ due to reverse recovery time.
- In FET, $t_{PLH} < t_{PHL}$ due to large capacitance formed.

2. Power Dissipation (P_D)

- It is the amount of power dissipated in an IC.
- It is determined by the current " I_{CC} " which draws from the V_{CC} supply.

Collector current:

$$I_{CC} = \frac{I_{CCH} + I_{CCL}}{2}$$

where, I_{CCH} = current value when all inputs are HIGH.
 I_{CCL} = current value when all inputs are LOW.

Power dissipation:

$$P_{D(av)} = I_{CC} \times V_{CC} \text{ mW}$$

3. Figure of Merit (FOM)

$$FOM = t_{pd} \times P_{D(av)} \text{ picoJoules}$$

For the best operation of ICs, figure of merit (FOM) should be as small as possible.

4. Fan-in and Fan-out

The maximum number of inputs which can be applied to a logic gate is known as fan-in. On the other hand, fan out of a logic gate is the number of gates that can be driven by it.

$$\text{Fan out} = \left(\frac{I_{OH}}{I_{IH}} \right) \text{ or } \left(\frac{I_{OL}}{I_{IL}} \right) ; \text{ whichever is minimum}$$

Note:

High fan-out is advantages because it reduces the need for additional drivers to drive more gates.

5. Noise-Margin

It is the property of a logic circuit to withstand unwanted noise voltage at input or the maximum value of noise signal that a system can reject with performance unaffected.

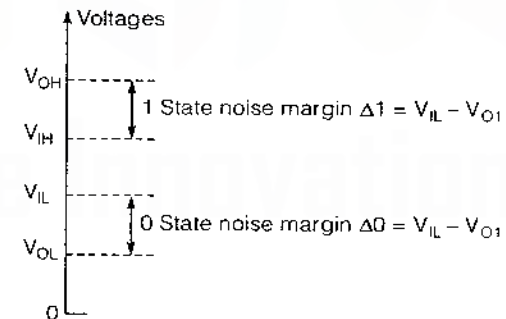

$$V_{OH} > V_{IH} > V_{IL} > V_{OL}$$

$$\text{High state N.M.} = V_{NH} = V_{OH(min)} - V_{IH(min)}$$

$$\text{Low state N.m} = V_{NL} = V_{IL(max)} - V_{OL(max)}$$

Bipolar Logic Families

Resistor Transistor Logic (RTL)

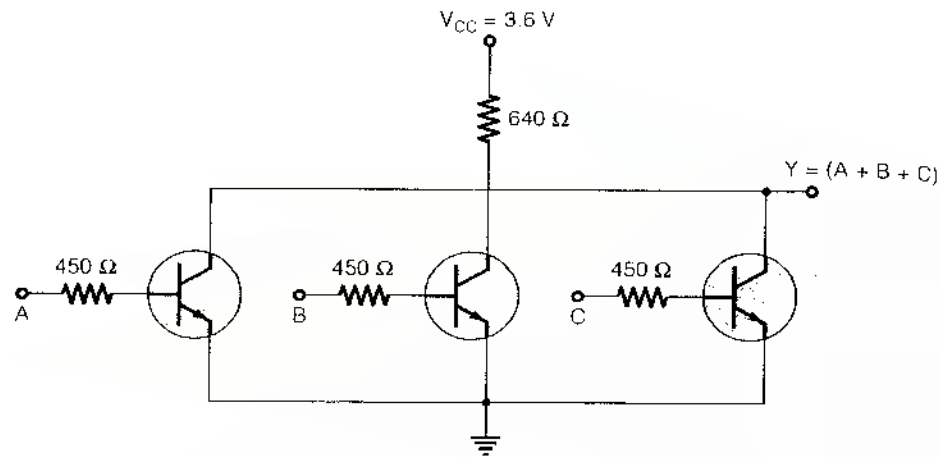

- RTL provides wired AND logic.

Diode Coupled Transistor Logic (DCTL)

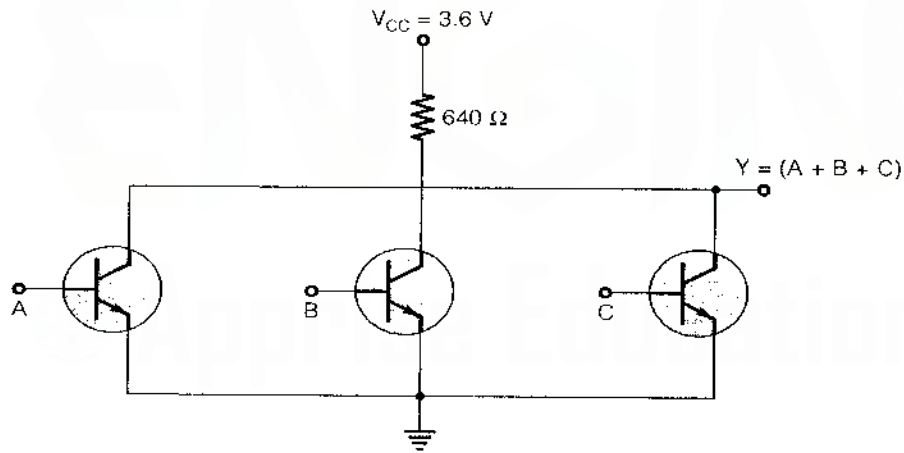

- DCTL provides wired AND logic.
- It suffers from "current Hogging".

Diode Transistor Logic (DTL)

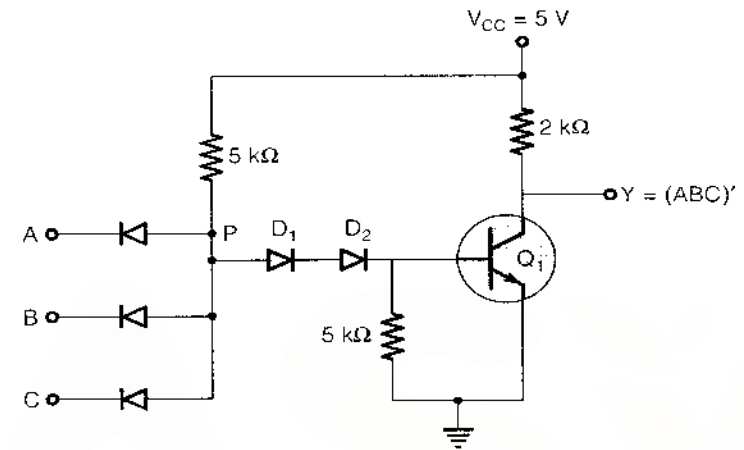

- DTL provides wired AND logic.

High Threshold Logic (HTL)

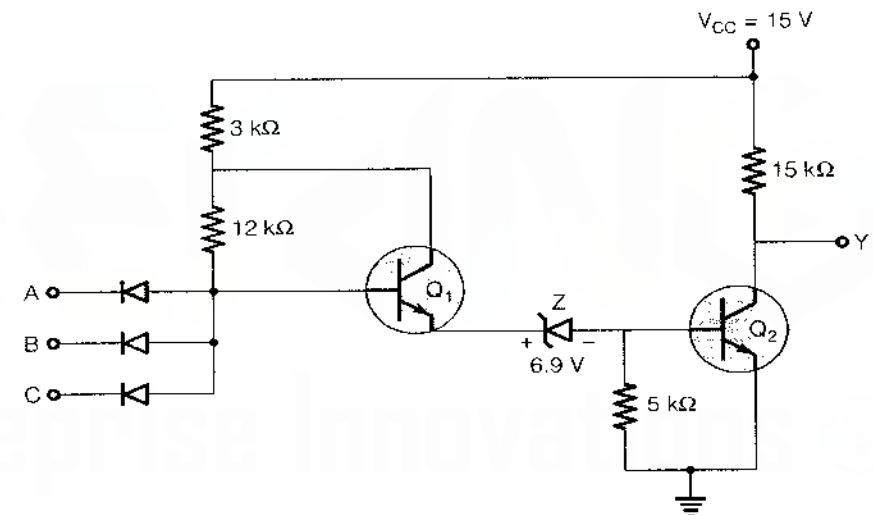

- HTL circuits has excellent noise margin and largest voltage swing.

MOS Logic Family

- MOS digital ICs use enhancement MOSFETs exclusively.
- Because of the symmetrical construction of source (S) and drain (D), the MOS transistor can be operated as a bilateral device.

N-Channel MOS (NMOS)

- It is faster than PMOS.
- NMOS conducts whenever input is HIGH.

Symbol

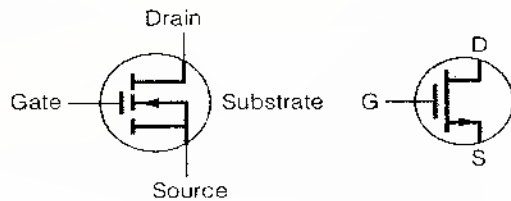

Different Logic Gates by NMOS

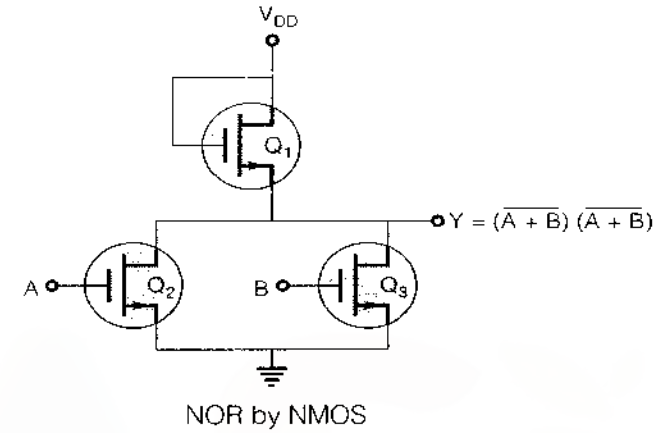
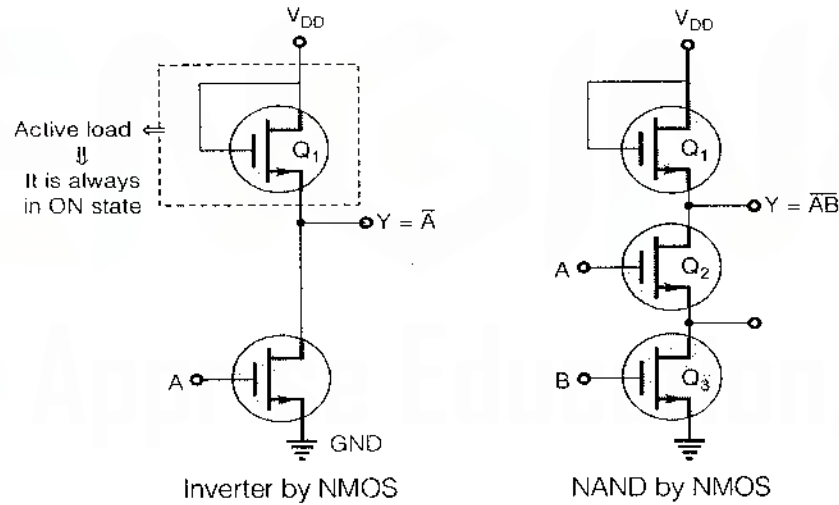

P-channel MOS (PMOS)

- Also called "Pull-Up Network".
- PMOS uses FETs having heavily doped P-channel.
- PMOS conducts whenever input is LOW.

Symbol

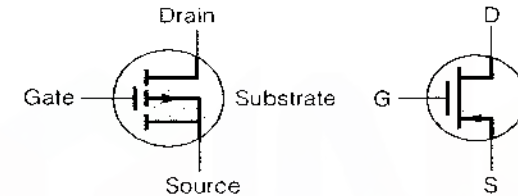

Different logic gates by PMOS

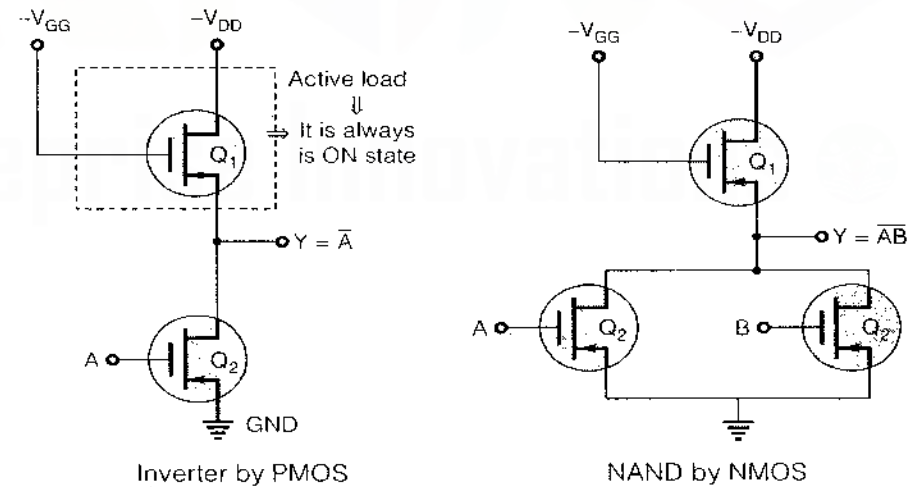

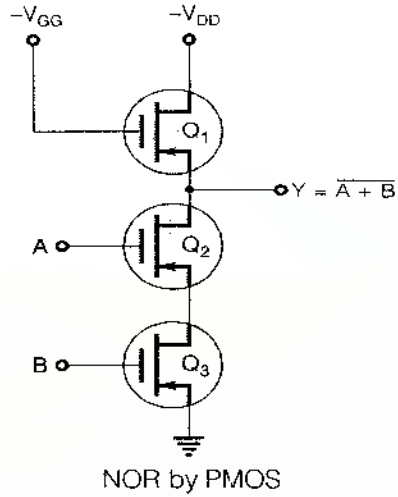

Complementary MOS (CMOS)

Different logic gates by NMOS

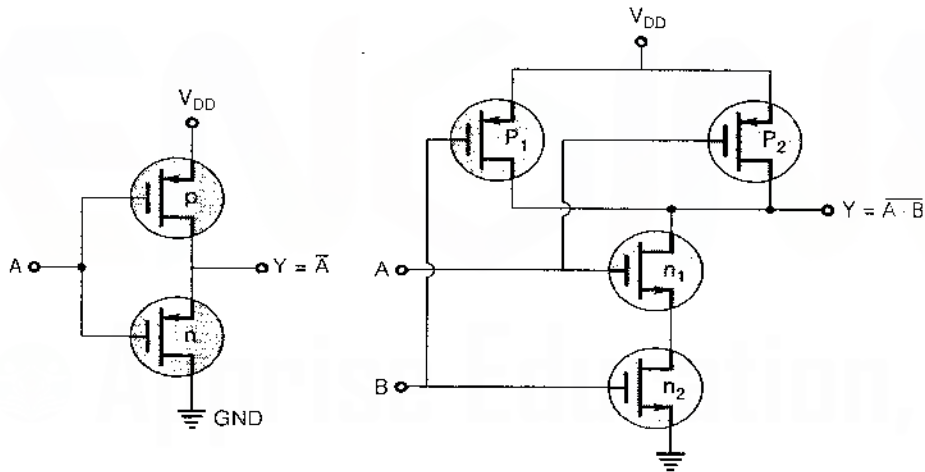

NOR by CMOS

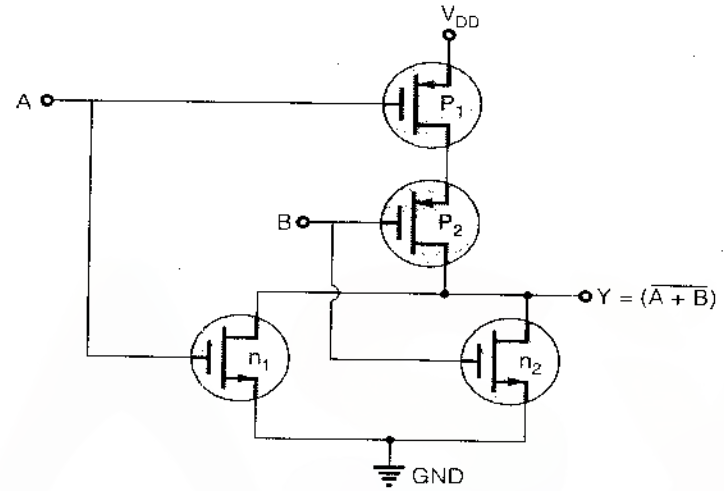

- Lower power dissipation.
- Excellent noise immunity.
- High packing density.
- Wide range of supply voltages.
- High speed.

Comparison of Various Logic Families

Logic parameter	Basic GATE	Fan-out	Power dissipation (mW)	T _{PD} (nsec)	F.O.M. (pJ)	N.M. (volt)
RTL	NOR	5	12	50	500	0.2
DTL	NAND	8	8-12	30	240	0.75
HTL	NAND	10	55	90	5000	4-5
TTL	NAND	10	12-22	12-6	144-132	0.4
ECL	OR/NOR	25	40-55	4-1	55-160	0.3
MOS	NAND/NOR	20	0.2-10	300	60	1.5
CMOS	NAND/NOR	>50	0-0.01	70	0.7	$\frac{V_{DD}}{2}$



Digital to Analog Converter (DAC)

Specification of DAC

1. Resolution

Resolution of DAC is change in analog voltage corresponding to LSB bit increment at the input.

$$\text{Resolution} = \frac{V_r}{2^n - 1}$$

where, V_r = Reference voltage corresponding to logic 1
 n = Number of bit

2. Analog Output Voltage

- Resolution × Decimal equivalent of binary data.
- Analog output voltage of an N-bit straight binary DAC

$$V_0 = K [2^{N-1} b_{N-1} + 2^{N-2} b_{N-2} + \dots + 2^2 b_2 + 2^1 b_1 + b_0]$$

where, K = Proportionality factor.

$b_n = 1$; if the n^{th} bit of digital input is '1'.
 $= 0$; if the n^{th} bit of digital input is '0'.

- Full scale output (V_{FS}) voltage is maximum output of DAC

$$\begin{aligned} V_{FS} &= \text{Resolution} * \text{Maximum decimal} \\ &= \frac{V_r}{2^n - 1} * (2^n - 1) \\ V_{FS} &= V_r \end{aligned}$$

3. % Resolution

$$\% \text{ Resolution} = \frac{\text{Resolution}}{V_{FS}} \times 100$$

$$\% \text{ Resolution} = \frac{1}{2^n - 1} \times 100$$

4. Error/Accuracy

Maximum error acceptable in ADC/DAC is 1 LSB bit which is equal to resolution.

Weighted-Resistor DAC

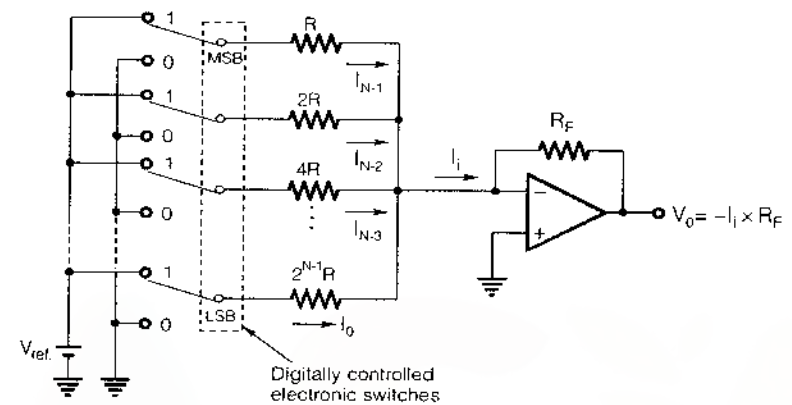

Output voltage:

$$V_0 = \frac{R_F}{2^{N-1} \cdot R} (2^{N-1} V_{N-1} + 2^{N-2} V_{N-2} + \dots + 2^1 V_1 + 2^0 V_0)$$

Proportionality factor:

$$K = \frac{R_F}{2^{N-1} \cdot R} \cdot V_r$$

Input current to OP-AMP:

$$I_i = \frac{V_{ref}}{2^{N-1} \cdot R} \sum_{i=0}^{N-1} 2^i b_i$$

Maximum output current:

$$I_{max} = \frac{V_{ref}}{2^{N-1} \cdot R} (2^N - 1)$$

Resistance:

$$\text{LSB Resistance} = (2^{N-1}) \times \text{MSB Resistance}$$

Remember:

- The resistance values are weighted in accordance with the binary weight.
- Here "OP-AMP" is employed as a "summing amplifier".
- OP-AMP is used in negative feedback mode to work as a "current to voltage converter".
- For N-bit DAC
 - (i) Number of different levels = 2^N
 - (ii) Number of steps = $2^N - 1$

R-2R Ladder DAC by Using Non-inverting OP-AMP

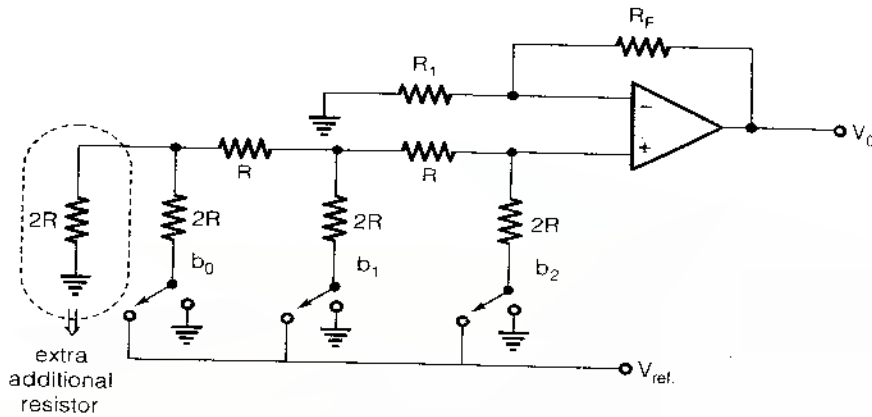

3-bit ($b_2 b_1 b_0$) R-2R ladder DAC

Gain of OP-AMP:

$$\frac{V_0}{V_{ref.}} = \left(1 + \frac{R_F}{R_1} \right)$$

where $V_{ref.}$ = Reference voltage or Input voltage
 V_0 = Output voltage

Output analog voltage:

$$V_0 = \frac{V_{ref.}}{2^N} \left[\sum_{i=0}^{N-1} 2^i b_i \right] \times \left[1 + \frac{R_F}{R_1} \right]$$

R-2R Ladder DAC by Using Inverting OP-AMP

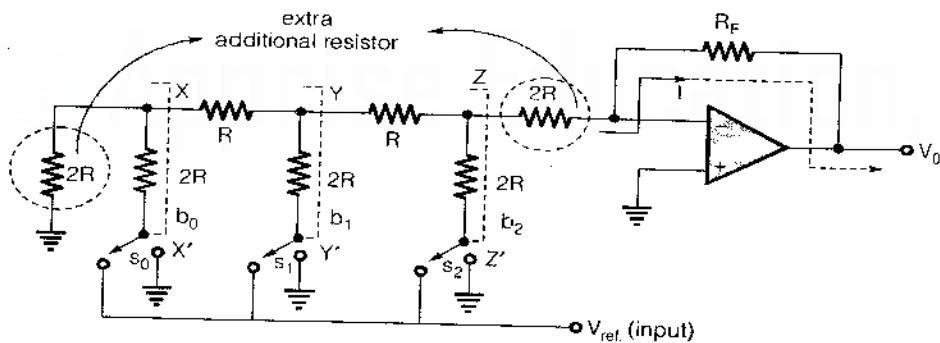

3-bit ($b_2 b_1 b_0$) R-2R ladder DAC

Output voltage:

For 3-bit DAC

$$V_0 = - \left(\frac{R_F}{3R} \right) \left(\frac{V_{ref.}}{2^3} \right) [4b_2 + 2b_1 + b_0]$$

For N-bit DAC

$$V_0 = \frac{V_{ref.}}{2^N} \times \left[\sum_{i=0}^{N-1} 2^i b_i \right] \times \left[\frac{-R_F}{3R} \right]$$

Output current:

$$I = \frac{V_{ref.}}{2^N} \times \left[\sum_{i=0}^{N-1} 2^i b_i \right] \times \left[\frac{1}{3R} \right]$$

Remember:

Resolution of R-2R ladder network is $\frac{V_r}{2^n}$.

Inverted Ladder (R-2R)type DAC

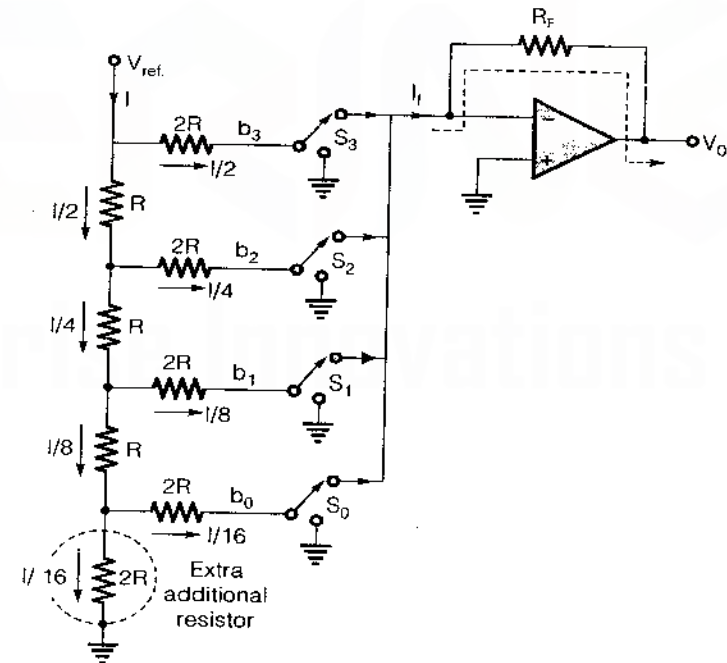

Output voltage:

For 4-bit DAC

$$V_0 = \frac{V_{ref}}{2^4} [b_0 + 2b_1 + 4b_2 + 8b_3]$$

For N-bit DAC

$$V_0 = \frac{V_{ref}}{2^N} \times \left[\sum_{i=0}^{N-1} 2^i b_i \right] \times \left(\frac{-R_F}{R} \right)$$

Forward current:

$$I_f = \frac{V_{ref}}{2^N} \times \left[\sum_{i=0}^{N-1} 2^i b_i \right] \times \frac{1}{R}$$

Note:

- ON-OFF Switches (S_0, S_1, S_2, S_3) are at the same potential.
- We always consider the bit as MSB, where the input reference voltage or supply to be given.
- The bit stream ($b_3 b_2 b_1 b_0$)₂ has MSB = b_3 and LSB = b_0 .

Analog to Digital Converter**Specifications of ADC****1. Voltage Range**

$$\text{Voltage range} = V_{max} - V_{min}$$

2. Resolution

$$\text{Resolution} = \frac{V_{range}}{2^n - 1}$$

$$\% \text{ Resolution} = \frac{1}{2^n - 1} \times 100$$

3. Dynamic range

$$\text{Dynamic range} = (1.8 + 6n) \text{ dB}$$

Types of ADCs are

- Counter type
- Successive approximation resistor type (SAR)
- Flash type
- Dual slope type

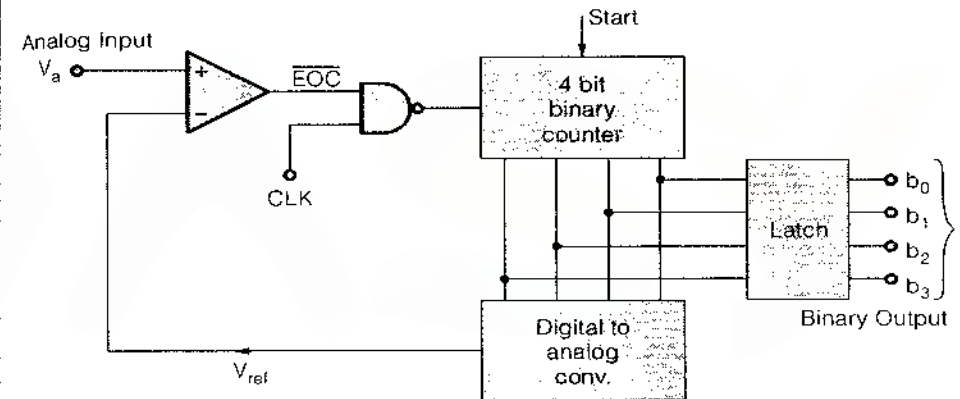
(a) Counter type ADC

- Number of clock pulse required for n-bit conversion = $2^n - 1$
- Maximum conversion time = $(2^n - 1) T_{clk}$
- Counter type ADC also known as 'ramp type' ADC.
- In this ADC, conversion time depends on input analog voltage.

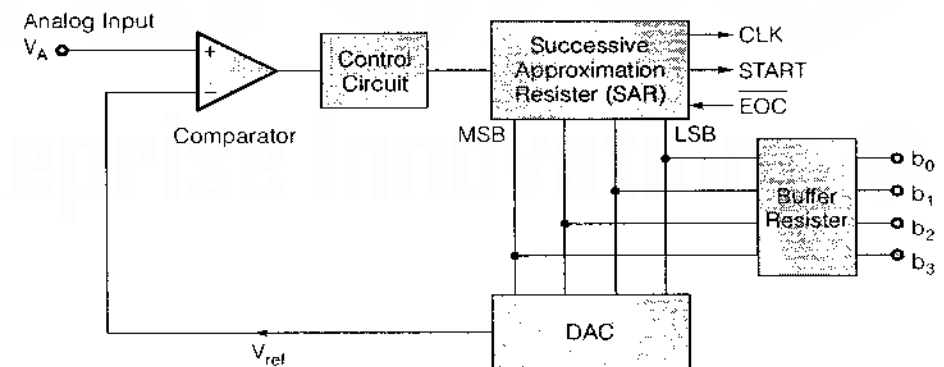
(b) SAR type ADC

- Number of clock pulse required for n-bit conversion = n.
- Maximum conversion time = $n * T_{clk}$
- In SAR ADC, conversion time is independent of input analog voltage.

(c) Flash type ADC

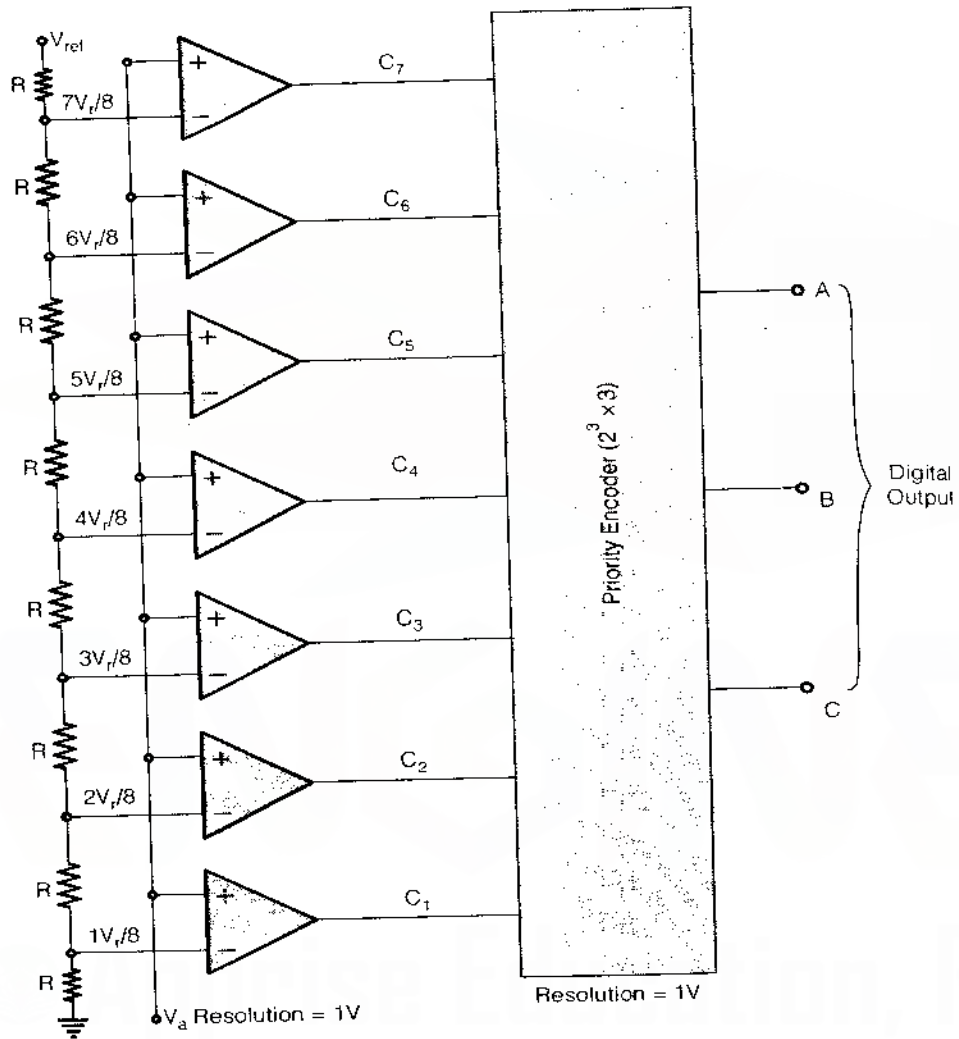

- For n bit conversion flash type ADC requires
 - $2^n - 1$ comparators
 - 2^n resistors
 - One $2^n \times n$ priority encoder
- It is the fastest ADC among all.
- It is also known as parallel comparator type ADC.

(d) Dual slope integrating type ADC

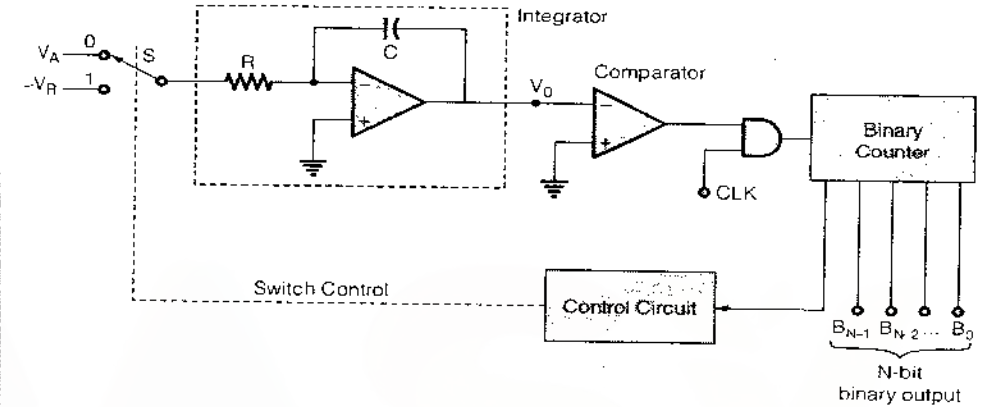

- Total number of clock pulse required = $2^n + N \approx 2^n + 1$.
- It is most accurate ADC therefore mostly used in digital voltmeter.
- It is slowest ADC.



A Handbook on Electrical Engineering

10

Electrical Materials

CONTENTS

1. Dielectric Properties of Insulating Materials	551
2. Dielectric Breakdown	561
3. Magnetic Properties of Materials	564
4. Conductive Materials	571
5. Semiconductor Materials	577
6. Insulating Materials	580
7. Crystal Structure	584

Dielectric Properties of Insulating Materials

1

Insulators

The insulating material is a substance which prevents the leakage of electric current in unwanted directions. In other words, when the main function of nonconducting materials is to provide electrical insulation they are called insulators.

Dielectrics

Dielectrics is a nonconducting materials which can be polarized in the presence of electric field. In other words materials which form charged dipole instantaneously under the influence of electric field are known as dielectrics i.e. they have ability to store energy when external electric field is applied. The dielectrics are of two types i.e. polar and non-polar.

Remember:

A dielectric is always an insulator.

Dielectrics Parameter

1. Permittivity (ϵ)

The term permittivity or dielectric constant is the measurement of electrostatic energy store within it and therefore depends on the material.

$$\epsilon = \epsilon_r \epsilon_0$$

where, ϵ_r = Relative permittivity
 ϵ_0 = Permittivity of vacuum
 $\epsilon_0 = 8.854 \times 10^{-12}$ Farad meter⁻¹

Note:

- Unit of permittivity is farad meter⁻¹.
- Relative permittivity of vacuum is equal to 1.
- ϵ_r is a dimension less quantity for construction of condenser the relative permittivity should be as high as possible
- Materials used for capacitor (ceramic) have higher dielectric constant than polymer.

2. Dipole Moment

Two charge of equal magnitude but opposite in polarity placed distance d apart constitute a dipole moment.

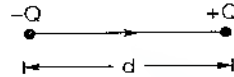

$$\bar{p} = Q\bar{d} \text{ Debye}$$

Note:

- Dipole moment is a vector quantity and pointing from the negative charge to the positive charge.
- 1 Debye = 3.33×10^{-30} Coulomb - meter

3. Polarization

The electric dipole moment per unit volume is called as polarization.

$$P = Np \text{ Coulomb / m}^2$$

Where, N = Number of dipoles per unit volume.

In many dielectric materials the polarization vector is proportional to the electric field E , as

$$P = \epsilon_0 \chi_e E \text{ and } P = \epsilon_0 (\epsilon_r - 1) E$$

Where, E = Electric field intensity
 χ_e = Electrical susceptibility

$$\chi_e = \epsilon_r - 1$$

Note:

χ_e is a measure of the ability of the material to become polarized.

$$\chi_e = \frac{\text{Bound charge density}}{\text{Free charge density}}$$

4. Polarizability

The elemental dipole moment is proportional to electric field strength E , that acts on the particle so that,

$$p = \alpha E$$

Where, α = Polarizability, Farad-m²
 E = Electric field intensity, V/m
 p = Dipole moment, Coulomb-m

$$\alpha = \frac{\epsilon_0 \chi_e}{N} = \frac{\epsilon_0 (\epsilon_r - 1)}{N}$$

Note:

α represents the extent of degree of polarization.

5. Electric Flux Density

$$\bar{D} = \epsilon \bar{E} \text{ ... for isotropic materials.}$$

Remember:

- In isotropic materials ϵ is independent of the direction.
- Electric flux density when an electric field is applied.

$$D = \epsilon_0 E + P$$

- The stored energy per unit volume in a dielectric medium due to polarization.

$$W = \frac{1}{2} PE$$

Mechanism of Polarization

1. Electronic polarization

The electronic polarizability of a molecule can be define as the dipole moment induced per unit field strength resulting only from shift of the electron clouds relative to nuclei.

$$P_e = N\alpha_e E$$

Where, α_e = Electronic polarizability

$$\alpha_e = 4\pi \epsilon_0 R^3$$

Where, R = Radius of atom

$$\alpha_e = \frac{\epsilon_0 (\epsilon_r - 1)}{N}$$

$$\epsilon_r = 1 + 4\pi NR^3 \text{ ...for rare gases}$$

2. Ionic polarization

When in a molecule some of the atoms have excess positive and negative charges resulting from ionic character of the bonds, an electric field will tend to shift positive ions relative to nuclei.

$$P_i = N\alpha_i E$$

Where α_i = ionic polarizability

Note:

- $\alpha_i = \frac{1}{10} \times \alpha_e$.
- Ionic polarization is independent of temperature.

3. Orientational polarization

When an internal field is applied to a molecule carrying a permanent dipole moment, the external field will tend to align the dipole along the direction of external field by applying a torque.

$$P_o = \frac{NP_p^2}{3KT} E$$

Where,
 N = Number of permanent dipoles
 P_p = Permanent dipole moment
 E = Applied external electric field intensity
 K = Boltzman constant
 T = Temperature in Kelvin

Orientational polarizability

$$\alpha_o = \frac{P_p^2}{3KT} \dots \text{Curie law}$$

Total polarization of a polygamic gas

$$P = P_e + P_i + P_o$$

$$P = N \left(\alpha_e + \alpha_i + \frac{P_p^2}{3KT} \right) E$$

$$\epsilon_0 x_e = N(\alpha_e + \alpha_i) + \left(\frac{NP_p^2}{3K} \right) \frac{1}{T}$$

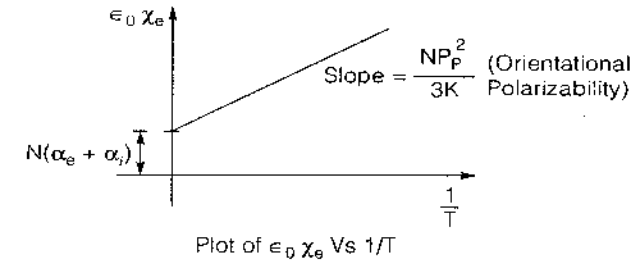

Note:

- Orientational polarization is dependent on temperature and frequency.
- Orientational polarization is applied only to polar dielectrics.

4. Interfacial Polarization or Space charge polarization

This type of polarization occurs due to accumulation of charges at the interfacing in a multiphase material.

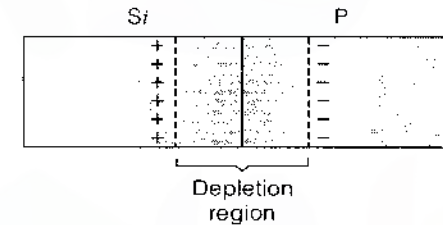

Net polarization

$$P = P_e + P_i + P_o + P_s$$

Where, P_s = Interfacial polarization

Note:

For single phase material, value of P_s become zero.

Internal Field in Solids and liquids

The internal field

$$E_i = E_{ext} + \frac{\gamma}{\epsilon_0} P$$

Where, P = Dipole moment per unit volume
 γ = Internal field constant

$\therefore \gamma, \epsilon_0, P$ are positive quantity. Thus

$$E_i > E_{ext}$$

Note:

For cubic lattice $\gamma = 1/3$ and internal field is called Lorentz's internal field and given by

$$E_{i(\text{Lorentz's})} = E_{ext} + \frac{P}{3\epsilon_0}$$

Types of Dielectric Materials**1. Elemental Solid Dielectrics**

These are the materials consisting of single type of atoms. Such materials contains neither ions nor permanent dipoles.

$$\epsilon_r = (\chi_e + 1) = \frac{1 - (1 - \gamma) \frac{N\alpha_e}{\epsilon_0}}{1 - \gamma \frac{N\alpha_e}{\epsilon_0}}$$

Remember:

- In elemental solid dielectric only electronic polarization exhibit.
- Diamond, sulphur, germanium etc. are example of elemental dielectric materials.

2. Ionic Nonpolar Solid Dielectrics

These solids contains more than one type of atoms, but no permanent dipoles. In ionic crystals the total polarization is electronic and ionic in nature.

3. Polar Solid

In these solids molecules possess permanent dipole moments. The total polarization has all the three components, i.e., ionic, electronic and orientational polarization.

Clausius-Mosotti relation

$$\frac{N\alpha_e}{3\epsilon_0} = \frac{\epsilon_r - 1}{\epsilon_r + 2}$$

where N = Number of molecules per unit volume
 α_e = Electronic polarizability

Maxwell's relation for index of refraction

$$\epsilon_{re} = n^2 \quad (\text{assuming } \mu = \mu_0)$$

where ϵ_{re} = Dielectric constant at optical frequencies
 n = Refractive index
 μ = Magnetic permeability of material
 μ_0 = Magnetic permeability of vacuums

In Clausius-Mosotti relations, for gases at low pressure

$$\epsilon_r = 1 \quad \text{or} \quad \epsilon_r + 2 = 3$$

So,

$$\frac{N\alpha_e}{\epsilon_0} = \epsilon_r - 1 = \chi_e$$

Debye's generalization of Clausius-Mosotti relation

- Polarizability per kilogram molecule

$$\pi = \frac{N_A \alpha}{3\epsilon_0} = \frac{\epsilon_r - 1}{\epsilon_r + 2} \frac{M}{\rho}$$

where π = Molar polarizability
 N_A = Avogadro's number
 $= 6.023 \times 10^{26}$
 α = Polarizability which includes effect of orientational polarization
 M = Molecular weight of material, kg
 ρ = Density, kg/m³

- Maxwell's relation for optical frequencies or Lorentz-Lorentz equation

$$\pi = \frac{N_A \alpha}{3\epsilon_0} = \frac{n^2 - 1}{n^2 + 2} \frac{M}{\rho}$$

where n = Refractive index

Note:

Lorentz-Lorentz equation will apply only for the case $\alpha = \alpha_e$.

• Condition for spontaneous polarization

$$\frac{N\alpha\gamma}{\epsilon_0} = 1$$

where, N = Number of molecules per unit volume, m^{-3}
 α = Polarizability, Farad- m^2
 γ = Internal field constant

Curie-Weiss Law

$$\chi_e = \frac{C}{T - \theta}$$

where, C = Curie constant
 θ = Characteristic temperature which is usually a few degree smaller than the ferroelectric Curie temperature θ_f .
 T = Temperature

Note:

Above temperature θ , the spontaneous polarization vanishes and the material becomes piezoelectric from ferroelectric.

Classification of Dielectric Material Based on the Dielectric Behavior in the Presence of Electric Field

1. Piezoelectric Material

Piezo electric materials are those which get polarized when they are subjected to mechanical stress. Piezo electric material also get strained when subjected to electrical stress.

Example:

Quartz crystal, $BaTiO_3$ crystal, $BaTiO_3$ ceramic modified lead zirconate titanate ceramic, Rochelle salt.

Piezoelectricity

- **Direct Effect:** The application of stress to a crystal produces a strain which results in a net polarization.
- **Inverse Effect:** The application of an electric field produces a strain whose sign depends on the field direction
- These are both linear effects. Such materials obey the following equations:

$$\left. \begin{aligned} T &= cS \\ S &= sT \end{aligned} \right\} \dots(i)$$

$$P = dT \dots(ii)$$

- A stress T results in a strain S in a material and c is an elastic stiffness constant; s is reverse of c . The stress T will produce a polarization; d is called piezoelectric strain constant.
- The dielectric displacement, in the presence of stress.

$$D = \epsilon E + dT \dots(iii)$$

and the inverse effect is given by the relation

$$S = sT + dE \dots(iv)$$

2. Ferroelectric Material

A ferroelectric material is one which exhibits an electric dipole moment and is said to be spontaneously polarised even in the absence of an electric field. Ferroelectric shows a hysteresis in polarization.

Example:

Rochelle salt, KDP, Barium titanate, sodium nitrite, lead titanate.

Note:

- The direction of polarization can be reversed by applying an external field in reverse direction of spontaneous polarization.
- Curie weiss law only applicable for ferroelectric material.

3. Pyroelectric Material

Pyroelectric material are those which exhibits spontaneous polarization in the absence of external electric field and changes its polarization on heating.

$$\Delta P = \lambda \Delta T$$

where, ΔP = Change of polarization
 λ = Pyroelectric constant
 ΔT = Change in temperature

Example:

Tourmaline and polyvinylidene fluoride.

4. Anti-ferroelectric Material

These are materials in which the dipole moment are aligned in anti-parallel direction therefore net spontaneous polarization is zero.

parallel direction therefore net spontaneous polarization is zero.

Example:

ADP, Lead Zirconate, Sodium Nibate.

Remember:

- All ferroelectric can be piezoelectric and pyroelectric
- All pyroelectric are piezo electric
- All piezoelectric are not pyroelectric
- All pyroelectric are not Ferroelectric.



Dielectric Breakdown

Dielectric Breakdown of Gases

- Average velocity of the charge carrier in a gas

$$v = \mu E$$

where μ = Mobility of the charge carrier

E = Applied electric field

Condition of Ionization

$$E \cdot \lambda = V_i$$

where V_i = Ionization potential

λ = Mean free path

- Electron ionization coefficient (Townsend breakdown process)

$$\alpha = \frac{1}{\lambda} e^{-(V_i/E\lambda)}$$

where, α = Townsend's first ionization coefficient
or ionization coefficient of electrons

$$\lambda \propto \frac{1}{\text{Pressure}} \quad \dots \text{at constant temperature}$$

$$n_d = n_0 e^{\alpha d}$$

where, n_d = Number of electrons striking the anode per second

- Secondary ionization coefficient

$$n = \frac{n_0 e^{\alpha d}}{1 - \gamma (e^{\alpha d} - 1)}$$

where, n = Total number of electrons arriving at the anode

n_0 = Number of primary photoelectrons per second emitted from cathode

d = Distance between anode and cathode

γ = Townsend's second ionization coefficient

Townsend criterion for spark breakdown

$$\gamma (e^{\alpha d} - 1) = 1$$

Note:

The avalanche breakdown develops over relatively long period of time over 1 μ s and does not generally occur with impulse voltage.

Dielectric Breakdown of Liquids

- Colloidal theory

$$\frac{\epsilon - \epsilon'}{\epsilon + 2\epsilon'} r^3 E^2 \geq \frac{kT}{4}$$

where r = Radius of insulating particle
 ϵ = Permittivity of insulating material
 ϵ' = Permittivity of oil
 E = Field strength
 k = Boltzmann's constant
 T = Absolute temperature

- Bubble theory

$$E_i = \frac{3\epsilon E_0}{2\epsilon + 1}$$

where E_i = Electric field in a gas bubble which is immersed in a liquid
 ϵ = Permittivity of liquid
 E_0 = Electric field in the liquid in absence of the bubble

- Break down due to liquid globules

$$E = 487.7 \sqrt{\frac{\sigma}{R\epsilon_1}} \text{ V/cm}$$

where E = Critical field at which the globule loses its stability
 ϵ_1 = Permittivity of the liquid medium
 σ = Pressure due to surface tension, dyne/cm
 R = Radius of globule

Dielectric Breakdown of Solids

- Theory of Von Hippel

$$E_c = \frac{2\pi^2 v e m}{h} \left[\frac{1}{n^2} - \frac{1}{\epsilon} \right] \text{ V/m}$$

where E_c = Critical field at which the breakdown occurs
 v = Optical frequency of lattice
 n_∞ = The index of refraction for infinite wave length
 ϵ = Dielectric constant
 m = Effective mass of electron
 e = Electron charge
 h = Plank's constant

Thermal breakdown

- Heat generated per unit volume in unit time

$$W = E^2 f \frac{\epsilon_r \tan \delta}{1.8 \times 10^{12}} \text{ Watts/cm}^3$$

where E = Uniform electric field
 f = Frequency of applied voltage
 δ = Loss angle
 ϵ_r = Relative permittivity

For direct voltage

Power dissipated per volume is given by

$$W = \frac{E^2}{\rho} \text{ Watts/m}^3$$

where ρ = Resistivity of the insulation, ohm-m

- Power loss

$$\epsilon \tan \delta = \epsilon' \tan \delta' \cdot e^{c(T - T')}$$

where $\epsilon \tan \delta$ = Loss factor of the dielectric at a temperature
 $\epsilon' \tan \delta'$ = Loss factor of the dielectric at the initial temperature
 T'
 c = Coefficient depending on the properties concerned



Magnetic Properties of Materials

3

Magnetic Field

- Force on a current Element

$$dF = I(d\vec{l} \times \vec{B})$$

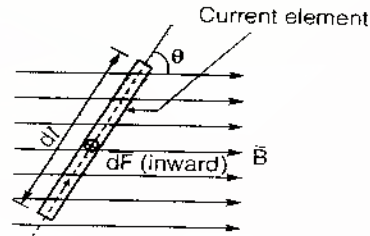

where, B = Flux density, Wb/m^2
 dF = Force on conductor, Newtons
 $d\vec{l}$ = Differential length of current carrying conductor, metres
 I = Current in conductor

For linear conductor of length l in a uniform field B

$$\vec{F} = I(\vec{l} \times \vec{B})$$

- Biot savart law

$$d\vec{B} = \frac{\mu}{4\pi} \frac{I(d\vec{l} \times \vec{r})}{r^3}$$

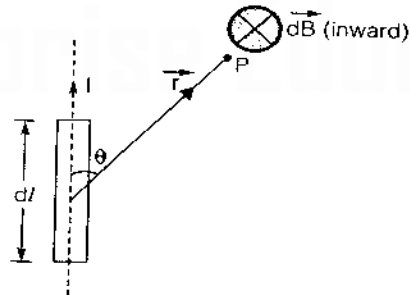

where, \vec{dB} = Magnetic flux density produced by a current carrying element

\vec{r} = Radius vector

- Flux density produced by a infinitely long current carrying wire at a distance R

$$B_p = \frac{\mu I}{2\pi R}$$

- Torque on a current carrying loop

$$T = BINA \sin \alpha$$

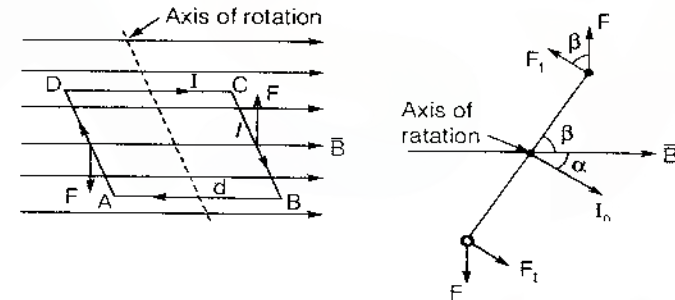

where, A = Area of the loop = ld
 α = Angle between normal to the plane of the loop and direction B
 N = Number of loops

Torque

$$\vec{T} = \vec{p}_m \times \vec{B}$$

Magnetic Parameters

1. Permeability

In magnetic field the relationship between two principal quantities i.e. magnetic field intensity (H) and magnetic flux density (B) is given by

$$B \propto H$$

$$B = \mu H$$

Where, μ = Permeability of the material or medium measured in henry/meter

$$\mu = \mu_r \mu_0$$

Where, μ_0 = Permeability of free space
 $= 4\pi \times 10^{-7}$ H/M
 μ_r = relative permeability

2. Magnetic Dipole Moment

The magnetic field reduces by a small current loop is called magnetic dipole. The magnetic dipole moment is defined as the product of the area of the loop to the magnitude of the circulating current

$$\vec{p}_m = i \cdot A \cdot \hat{n}; \text{ Ampere-m}^2$$

Note:

- It is a vector quantity.
- For a permanent bar magnet the dipole moment is defined as the product of pole strength and distance between them.

3. Magnetization

Magnetization is defined as the total magnetic dipole moment per unit volume,

$$M = \frac{p_m}{\text{volume}}; \text{ Ampere/m}$$

$$M = N p_m$$

Where, N = Number of magnetic dipoles per unit volume.
 p_m = Elementary dipole moment

4. Magnetic Flux Density

$$B = \mu H$$

where H = Magnetic field intensity

Note:

The above equation is valid for the materials in which factor 'M' is constant or in homogeneous magnetic field.

- Magnetic flux density when a magnetic field is applied

$$B = \mu_0 H + \mu_0 M = \mu_0 \mu_r H$$

- Magnetization

$$M = (\mu_r - 1)H = \chi_m H$$

- Magnetic susceptibility

$$\chi_m = \mu_r - 1$$

Remember:

- For diamagnetic materials χ_m is negative
- For paramagnetic materials χ_m is small and positive
- For ferromagnetic materials χ_m is large and positive

Types of Magnetic Materials (Depending upon susceptibility)

1. Diamagnetic materials

Do not have permanent dipole moment

$$\vec{p}_m \equiv \vec{p}_{m,orb} + \vec{p}_{m,spin} = 0$$

Such material get magnetize in the opposite direction of applied magnetic field.

Remember:

- For perfect diamagnetic material, $\chi_m = -1$
- In general, χ_m comes out to the order of -10^{-5} to -10^{-6} .

Magnetic susceptibility

$$\chi_m = -\frac{Ne^2}{4m} r^2 \mu_0$$

2. Paramagnetic material

These materials have positive but very small of susceptibility. Spontaneous magnetization for paramagnetic material is zero

Magnetic susceptibility

$$\chi_m = \frac{N\beta^2 \mu_0}{kT}$$

Curie law**Magnetic susceptibility**

$$\chi_m = \frac{C}{T}$$

where C = Curie constant
T = Temperature

Example: MnSO_4 , FeSO_4 , FeCl_3 .

3. Ferromagnetic Material

- These are the material which get spontaneously magnetize even in the absence of external field.
- These materials are characterized the parallel alignment of the dipoles in a single direction.
- These material have very large and positive value of susceptibility.
- The magnetic field inside the ferromagnetic material, when the effect of internal field is considered

$$H_i = H + \gamma M$$

where, γ = internal or molecular field constant
 γM = Measure of tendency of environment to align a particular dipole parallel to the magnetisation already existing

Curie weiss law**Magnetic susceptibility**

$$\chi_m = \frac{C}{T - \theta}; T > \theta$$

where θ is Paramagnetic curie temperature. Above this temperature the ferromagnetic material behaves as a paramagnetic material.

Example: Fe, CO, Ni etc.

4. Antiferromagnetic Material

These materials have positive but small value of susceptibility the magnetic moment of adjacent atoms are align in the opposition direction so that the net magnetic moment of the specimen become zero even in the presence of field.

Curie weiss law**Magnetic susceptibility**

$$\chi_m = \frac{C}{T + \theta_n}$$

where, θ_n = Need temperature

Example: MnO , MnO_2 , NiO , Cr_2O_3 .

5. Ferrimagnetic Material

- In this material the adjacent atoms are align in the opposite direction but the moments are not equal and therefore there is a net magnetic moment along a particular direction.
- Ferrimagnetic materials are also known as ferrites. For example, hard ferrites, soft ferrites rectangular loop ferrites and microwave ferrites.

Magnetostriction

Magnetostriction is an effect that describes a change in dimension when a ferromagnetic material is exposed to magnetic field. It is of three types.

1. Longitudinal magnetostriction

Which is change length in the direction of magnetization.

2. Transverse magnetostriction

Change in dimension, perpendicular to magnetization direction.

3. Volume magnetostriction

Change in volume result from the above two effects.

Villari effect

This effect is inverse of magnetostriction when material is subjected to mechanical stress, the magnetic properties of material changes.

Types of Magnetic Materials**1. Soft Magnetic Materials**

Soft magnetic are easy to magnetize and easy to demagnetize. The direction of magnetization can be altered easily by applying an external field in the reverse direction.

Note:

- Soft magnetic have high permeability and low coercive force.
- Soft magnetic material having small hystereses losses, lower retentivity.
- Soft magnetic material are used as the core of the transformer, electric machines and magnetic memory.

2. Hard Magnetic Materials

These magnetic materials are hard to magnetize and hard to demagnetize. These materials retain high value of residual flux density and coercive force. These materials are also called as permanent magnetic materials.

Note:

- hard magnetic materials having large hystereses loss, higher residual magnetism.
- hard magnetic materials having high curie temperature
- hard magnetic materials are used in measuring instrument transducers and picture tube.

Remember:

- Permanent magnet-High retentivity and high coercivity.
- Electromagnets-High retentivity and low coercivity.
- Transformers-Least possible area of Hysteresis.

**Conductive Materials****4****Electrical Conductivity**

A very important electrical property of a material is its resistivity.

$$R = \rho \cdot \frac{l}{A}$$

Electrical resistivity is reciprocal of electrical conductivity and denotes by σ

Where, R = Resistance of conductor, Ω

ρ = Resistivity of the material, $\Omega\text{-m}$

l = Length of conductor, m

A = Area of cross section, m^2

σ = Conductivity of material $\Omega^{-1}\text{-m}^{-1}$.

Ohm's Law

$$J = \sigma E = \frac{I}{A} \text{ A/m}^2 \dots \text{Point form}$$

J = current density, A/m^2

σ = conductivity of material, $\Omega^{-1}\text{-m}^{-1}$

E = Applied electric field, v/m

I = current, A

Joule's Law

Volume density of heat developed per second

$$W = \sigma E^2 = JE \text{ Watts/m}^3$$

Remember:

This is the energy which the electrons transfer to the lattice in the collision process and is converted into heat.

Mobility and Conductivity

It is the magnitude of the average drift velocity per unit field.

$$\mu_e = \frac{e\tau_c}{m} \quad \text{also} \quad \sigma = \frac{ne^2\tau_c}{m}$$

Mobility and conductivity have the relation

$$\sigma = ne\mu_e$$

Where, n = Number of electrons per unit volume,
 τ_c = collision time, sec
 e = charge of electron
 m = mass of electron
 μ_e = mobility of electron, $m^2 \text{ volt}^{-1} \text{ sec}^{-1}$

Drift Velocity of Electron

This velocity is associated with the electric field and is called drift velocity (V_d)

$$V_d = \frac{e\tau_c E}{m} = \mu_e E \quad \text{m/sec}$$

Mean Free Path (d)

It is average distance travelled by electron before the collision takes place

$$d = V\tau_c$$

Where, V = Average electron velocity

Velocity of an electron

$$V_p = \sqrt{\frac{2E_F}{m}}$$

Where, E_F = Fermi energy

Note:

At absolute zero, all energy levels below a certain value E_F are filled, and all those above E_F being empty; E_F is the Fermi level of electron.

Relaxation time (τ_r)

It is defined as, the time at which the drift velocity of electrons reduces to 37% of its initial value after the removal of the field.

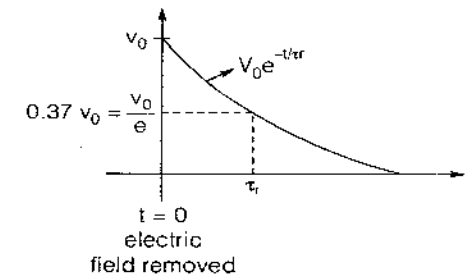

Note:

For isotropic materials, the mean time of collision is the same as the relaxation time.

Mean free path at Fermi level:

$$d_F = \tau_c \sqrt{\frac{2E_F}{m}}$$

Thermal conductivity

- Flux of thermal energy

$$Q = -K \left(\frac{dT}{dx} \right) \quad \text{Watts/m}^2$$

where, K = Thermal conductivity, Watts/ m^2

$\frac{dT}{dx}$ = Temperature gradient, $^{\circ}\text{C/m}$

- Thermal conductivity

$$K = \frac{1}{3} n \pi^2 k^2 \tau T \quad \text{Watt/mK}$$

where n = Number of conduction electrons per m^3

T = Temperature

K = Boltzmann's constant

Note:

τ varies as T^{-1} above Debye temperature.

Super Conductors

In the state of super conductivity material exhibit zero resistivity and perfect diamagnetism.

Super conductivity appears at low temperature and in a magnetic lower than a particular level.

Example: Hg, Pb, Zn, PbAu, PbTL₂, ZrC, CuS

Transition temperature (T_c)

The critical temperature (T_c) is the temperature at which there is change of state from normal to super conducting and vice-versa is known as transition temperature.

Meissner's Effect

Magnetic susceptibility in a super conductor is negative. This is referred to as perfect diamagnetism. This phenomenon is called Meissner effect.

Flux lines in a sphere under different conditions of temperature and field

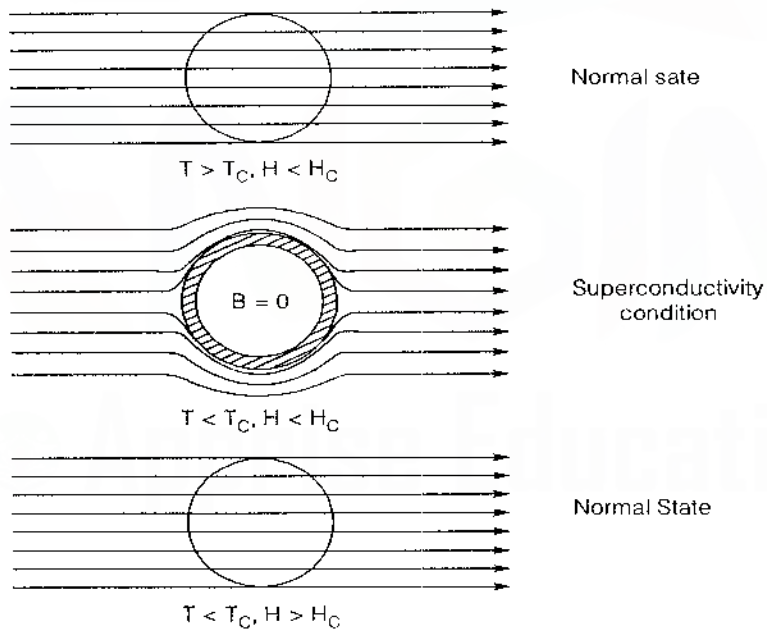

Critical Field (H_c)

It is possible to destroy superconductivity by the application of sufficiently strong magnetic field.

$$H_c = H_0 \left[1 - \left(\frac{T}{T_c} \right)^2 \right]$$

where, H₀ = Critical field at absolute zero temperature

H_c = Critical field at any temperature T

T_c = Transition temperature

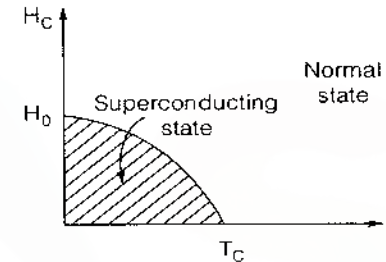

Silsbee's Rule

In a long superconductor wire of radius R, the superconductivity may be destroyed when a current I exceeds the critical current value I_c

$$I_c = 2\pi R H_c$$

Factors Affecting the Super Conductivity

1. Frequency effect

When frequency increases above 10¹³ Hz (infrared region); material loses its super conductivity.

2. Entropy effect

Increase in entropy results in, change in state from super conducting to normal.

3. Isotope Effect

It has been observed that the critical temperature of a super conductor varies with isotopic mass as

$$T_c \propto \frac{1}{\sqrt{M}}$$

where M is the mass of isotope

Types of Super Conductors

Type-I

- It is an ideal super conductor; also called soft super conductor.
- Their critical field and transition temperature values are low.
- They exhibits almost complete Meissner effect and Silsbee's rule.
- The change in state from normal to super conducting is abrupt.

Example: Th, Pd, Pb, V, Hg etc.

Type-II

- It is a non-ideal super conductor; also called hard super conductor.
- Their critical field and transition temperature values are high.
- They exhibits incomplete Meissner effect and Silsbee's rule.
- The change in state from normal to super conducting is gradual.

Example: Nb₃Sn.



semiconductor Materials

5

Conductivity of metal

$$\sigma = \frac{ne^2\tau}{m}$$

Where, n = density of conductor electron
 τ = Relaxation time

Conductivity of Semiconductor

The current flowing through a pure semiconductor is carried by two kinds of carriers, ie. electrons and holes.

Conductivity of a intrinsic semiconductor

$$\sigma = \frac{n_e e^2 \tau_e}{m_e} + \frac{n_h e^2 \tau_h}{m_h}$$

Where, τ_e, τ_h = Relaxation times for electrons and holes respectively.
 m_e, m_h = Effective mass of electrons and holes respectively.
 n_e, n_h = Number of conduction electrons and holes respectively.

- Current density

$$J = neV_d$$

where, V_d = Drift velocity

Mobility

Mobility of electron

$$\mu_e = \frac{e\tau_e}{m_e}$$

Mobility of Hole

$$\mu_h = \frac{e\tau_h}{m_h}$$

Concentration of holes in the n-type semiconductor

$$n_{hn} = \frac{n_i^2}{N_D}$$

Where, n_i = intrinsic concentration
 N_D = concentration of donor atom

Concentration of holes in the p-type semiconductor

$$n_{ep} = \frac{n_i^2}{N_A}$$

Where, N_A = Concentration of acceptor atom

Hall Effect

If a specimen (metal or semiconductor) carrying a current- I is placed in a transverse magnetic field B , an electric field E is induced in the direction perpendicular to both I and B . This phenomenon, known as Hall effect, is used to determine whether a semiconductor is n- or p-type and to find the carrier concentration. Also, by simultaneously measuring the conductivity σ , the mobility μ can be calculated.

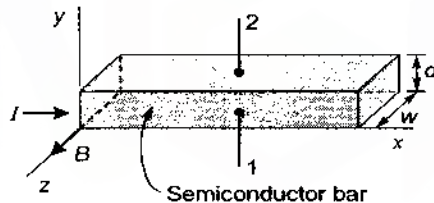

Hall Voltage

$$V_H = \frac{BI}{\rho w}$$

where, w = Width of the specimen
 ρ = the charge density

Hall Angle

$$\tan \theta_H = \frac{E_y}{E_x}$$

Hall Coefficient

$$R_H = \frac{E}{BJ} = \frac{1}{en_h} = \frac{-1}{en_e}$$

Where, E = Applied electric field
 B = Applied magnetic field
 J = Current density in the

If the conductivity is measured together with the Hall coefficient, the mobility can be determined from

$$\mu = \sigma R_H$$

Remember:

- For n-type semiconductor Hall voltage (V_H) and Hall coefficient (R_H) is negative.
- For p-type semiconductor Hall voltage (V_H) and Hall coefficient (R_H) is positive.
- Hall voltage is large for semiconductor than metal, since $V_H \propto R_H$ i.e.

$$V_H \propto \frac{1}{\sigma}$$

Einstein Relation (Electrical Mobility Equation)

$$D_h = \left(\frac{kT}{e}\right) \mu_h, \quad D_e = \left(\frac{kT}{e}\right) \mu_e$$

where D_h, D_e = Diffusion constant for holes and electron respectively

$$\frac{D_h}{\mu_h} = \frac{D_e}{\mu_e} = \frac{kT}{e}$$



Insulating Materials



Complex Permittivity

When an alternating field is applied to a dielectric, the relative dielectric constant become a complex quantity whose value is given by

$$\epsilon_r^* = \epsilon_r' - j \epsilon_r''$$

Where, ϵ_r' = real part of dielectric constant
 ϵ_r'' = imaginary part of dielectric constant

Remember:

- When a time varying electric field is applied to a dielectric material, the response is not entirely instantaneous

$$D = \epsilon'' E$$

- The imaginary part is responsible for energy loss in the material.
- The real part represents the relative permittivity

Debye Equations

It gives the variation of both the inphase and out of phase component of ϵ_r as a function of angular frequency ω with relaxation time τ

$$\epsilon_r' = \epsilon_\infty + \frac{\epsilon_s - \epsilon_\infty}{1 + \omega^2 \tau^2}$$

$$\epsilon_r'' = \frac{(\epsilon_s - \epsilon_\infty) \omega \tau}{1 + \omega^2 \tau^2}$$

Where, ϵ_∞ = dielectric constant at infinite frequency
 ϵ_s = dielectric constant under static field
 τ = relaxation time

Dielectric losses

The absorption of electric energy by the dielectric material subjected to an alternating electric field is known as the dielectric losses. This results in dissipation of the electrical energy as heat in a material.

Note:

Dielectric loss occurs due to two reason

- 1) Oscillation of the ion
- 2) continuous change in orientation of dipoles

Energy absorbed per m³

$$W = \frac{1}{2} \omega \epsilon_0 \epsilon_r'' E_0^2$$

Dielectric loss tangent

It represents how lossy the material is for electrical AC signals.

$$\tan \delta = \frac{\epsilon_r''}{\epsilon_r'}$$

Loss Factor

$$\epsilon_r' \tan \delta = \epsilon_r''$$

Lossy Capacitor

Equivalent circuits

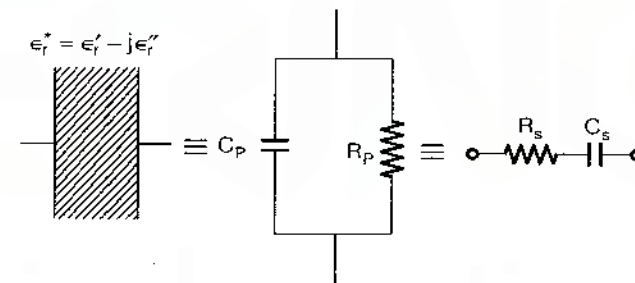

For parallel circuit

$$R_p = \frac{1}{\omega \epsilon_r'' C_0}$$

where C_0 = capacitance

$$C_0 = \frac{\epsilon_0 A}{d}$$

$$C_p = \epsilon_r' C_0$$

For series circuit

$$R_s = \frac{R_p}{1 + (\omega C_p R_p)^2}$$

$$C_s = \frac{1 + (\omega C_p R_p)^2}{\omega^2 C_p R_p^2}$$

Loss tangent

For series circuit

$$\tan \delta = \omega C_s R_s$$

For parallel circuit

$$\tan \delta = \frac{1}{\omega C_p R_p}$$

Quartz

Quartz is a piezoelectric material, used for high frequency oscillation

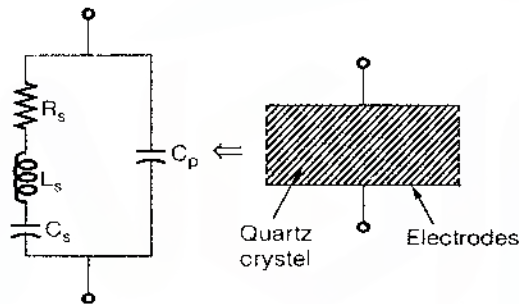

$$z = \left(\frac{1}{j\omega C_s} + j\omega L_s + R_s \right) \parallel \left(\frac{1}{j\omega C_p} \right)$$

- Q-factor

$$Q = \frac{\omega_s L_s}{R_s} = \frac{1}{\omega R_s C_s}$$

- Series resonance frequency

$$\omega_s = \frac{1}{\sqrt{L_s C_s}}$$

Impedance at series resonance frequency

$$Z|_{\omega=\omega_s} = R_s$$

- Parallel resonance frequency

$$\omega_p = \sqrt{\frac{1}{L_s} \left(\frac{1}{C_s} + \frac{1}{C_p} \right)} = \omega_s \sqrt{1 + \frac{C_s}{C_p}}$$

- Impedance at parallel resonance frequency

$$Z|_{\omega=\omega_p} = \frac{R_s^2 + \left(\omega_p L_s - \frac{1}{\omega_p C_s} \right)}{R_s}$$

$$Z|_{\omega=\omega_p} > Z|_{\omega=\omega_s}$$

Note:

Quartz crystal can be modelled as an electrical network with a low impedance (series) and a high impedance (parallel).



Unit Cell

The smallest unit of crystal structure which completely defined the behaviour of a crystal.

Number of atoms per unit cell

$$n = \frac{\rho a^3 N_A}{M}$$

where,

- a = Edge of unit cell
- M = Atomic weight of element
- ρ = Density of metal
- N_A = Avogadro's number = 6.023×10^{23}

Note:

- Unit cell is cubic in shape.
- Unit cell is repeated to form a crystal. So most important characteristic of crystal is periodicity of unit cell inside the crystal.

Simple Cubic (SC)

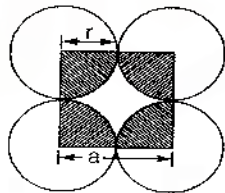

- Distance between adjacent atom

$$d_{sc} = 2r = a$$

where, r = Radius of an atom
 a = Edge length of cube

- Effective number of atom in a unit cell

$$Z_{sc} = 8 \times \frac{1}{8} = 1$$

- Atomic packing fraction

$$APF = \frac{\text{Volume occupied atoms}}{\text{Volume of the cell}}$$

$$APF_{sc} = \frac{\pi}{6} = 0.523$$

Example: Polonium

- Coordination number of simple cubic is 6.

Body Centered Cubic (BCC)

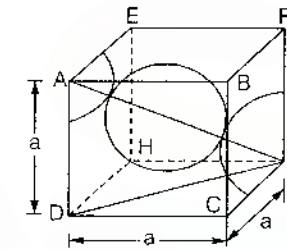

- The distance between adjacent atom

$$d_{BCC} = 2r = \frac{\sqrt{3}}{2} a$$

- Effective number of atom in unit cell

$$Z_{BCC} = 8 \times \frac{1}{8} + 1 = 2$$

- Atomic packing fraction

$$APF_{BCC} = \frac{\sqrt{3}}{8} \pi = 0.68$$

Example: Cr, Li, Na, K, Fe

- The coordination number of body centered cubic is 8.

Face Centered Cubic (FCC)

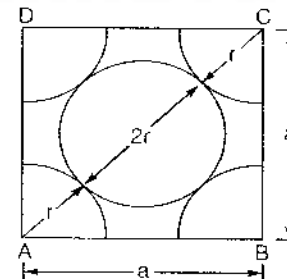

- The distance between adjacent atom

$$d_{\text{FCC}} = 2r = \frac{a}{\sqrt{2}}$$

- Effective number of atom in a unit cell

$$Z_{\text{FCC}} = 4$$

- Atomic packing fraction

$$\text{APF}_{\text{FCC}} = \frac{\pi}{3\sqrt{2}} = 0.7404$$

Example: Fe, Al, Cu, Au, Ca, Pb

- The coordination number of face centered cubic is 12.

Miller Index

$$\text{MI} = \frac{\text{Cell edge length}}{\text{Intercept by plane}}$$



A Handbook on Electrical Engineering

11

Electromagnetic Theory

CONTENTS

1. Vector Calculus	588
2. Coordinate system and Transformation	590
3. Electrostatics	599
4. Magnetostatic Field	608
5. Maxwell's Equations	614
6. Electromagnetic Wave Propagation	617
7. Incidence of EM Wave	623
8. Transmission Lines	627

Vector Calculus



Vector Analysis

Vector algebra

1. Addition

$$\vec{A} + \vec{B} = \vec{B} + \vec{A}$$

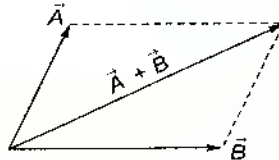

Note:

- It follows commutative law: $\vec{A} + \vec{B} = \vec{B} + \vec{A}$

- It also obeys associative law: $(\vec{A} + \vec{B}) + \vec{C} = \vec{A} + (\vec{B} + \vec{C})$

2. Subtraction

$$\vec{A} - \vec{B} = \vec{A} + (-\vec{B})$$

-ve sign shows reversal of direction

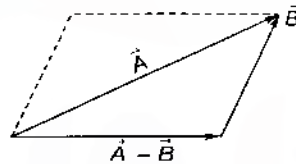

Note:

- It does not follow cumulative law: $\vec{A} - \vec{B} \neq \vec{B} - \vec{A}$

But follows associative law.

3. Multiplication

(i) Scalar or Dot product

$$\vec{A} \cdot \vec{B} = |\vec{A}| |\vec{B}| \cos \theta$$

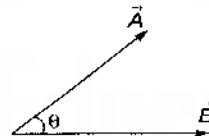

Note:

- $\vec{A} \cdot \vec{B} = \vec{B} \cdot \vec{A}$
- Dot product of vector is a scalar.

(ii) Vector or cross product

$$\vec{A} \times \vec{B} = |\vec{A}| |\vec{B}| \sin \theta \hat{i}_n$$

Where, \hat{i}_n = unit vector in the direction of perpendicular to \vec{A} and \vec{B}

Note:

- To find direction \hat{i}_n , use right hand screw rule.
- Cross product of two vectors is always a vector.
- $\vec{A} \times \vec{B} = -(\vec{B} \times \vec{A})$
- $(\vec{A} \times \vec{B}) \times \vec{C} = \vec{A} \times (\vec{B} \times \vec{C})$

(iii) Scalar triple product

$$\vec{A} \times (\vec{B} \times \vec{C}) = \vec{B} \cdot (\vec{C} \times \vec{A}) - \vec{C} \cdot (\vec{A} \times \vec{B})$$

4. A vector multiplied/divided by a scalar

- (i) $S \cdot \vec{V}$ = it increases the magnitude by S unit
- (ii) $\frac{\vec{V}}{S}$ = it decreases the magnitude by S unit
- (iii) $\frac{\vec{A}}{\vec{B}}$ = it does not exist

5. Differentiation of vectors

If $\vec{A} = A_x \hat{i}_x + A_y \hat{i}_y + A_z \hat{i}_z$

$$d\vec{A} = dA_x \hat{i}_x + dA_y \hat{i}_y + dA_z \hat{i}_z$$

For cylindrical and spherical coordinate system:

$$d\vec{A} = dA_r \hat{i}_r + dA_\phi \hat{i}_\phi + dA_z \hat{i}_z$$

and

$$d\vec{A} = dA_r \hat{i}_r + dA_\theta \hat{i}_\theta + dA_\phi \hat{i}_\phi$$



Coordinate system and Transformation

2

Coordinate System

Cartesian Coordinate system (x, y, z)

In Cartesian or rectangular coordinate system, the three coordinate axis mutually at right angles to each other.

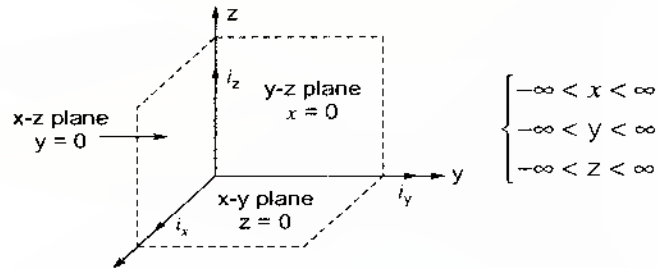

Remember:

- i_x, i_y and i_z are mutually perpendicular unit vectors drawn at point (x, y, z).
- $i_x \times i_y = i_z$; $i_y \times i_z = i_x$; $i_z \times i_x = i_y$
- $i_x \cdot i_x = i_y \cdot i_y = i_z \cdot i_z = 1$
 $i_x \cdot i_y = i_y \cdot i_z = i_z \cdot i_x = 0$
 $i_x \times i_x = i_y \times i_y = i_z \times i_z = 0$

1. Position vector

A vector drawn from the origin to an arbitrary point P (x, y, z) is called the position vector of point P.

$$\vec{r} = x\mathbf{i}_x + y\mathbf{i}_y + z\mathbf{i}_z$$

Remember:

- The purpose of position vector is, to locate a general point from origin.
- It's direction is always away from origin.

2. Displacement vector

$$d\vec{l} = dx\mathbf{i}_x + dy\mathbf{i}_y + dz\mathbf{i}_z$$

$$|d\vec{l}| = \sqrt{(dx)^2 + (dy)^2 + (dz)^2}$$

3. Unit vector

$$\vec{r} = x\mathbf{i}_x + y\mathbf{i}_y + z\mathbf{i}_z$$

$$|\vec{r}| = \sqrt{x^2 + y^2 + z^2}$$

4. Differential vector

(i) Differential length

$$dx\mathbf{i}_x + dy\mathbf{i}_y + dz\mathbf{i}_z$$

(ii) Differential normal surface areas

$$dS = dy\mathbf{i}_y \times dz\mathbf{i}_z = dy\,dz\mathbf{i}_x$$

Similarly; $dS = dz\,dx\mathbf{i}_y = dx\,dy\mathbf{i}_z$

(iii) Differential volume

$$dV = dx\,dy\,dz$$

5. Projection of a vector

Dot product of vector in given direction is projection of vector in that direction.

let $\vec{A} = A_x\mathbf{i}_x + A_y\mathbf{i}_y + A_z\mathbf{i}_z$

Projection of \vec{A} on a_B direction

$$OB = \vec{A} \cdot \mathbf{a}_B$$

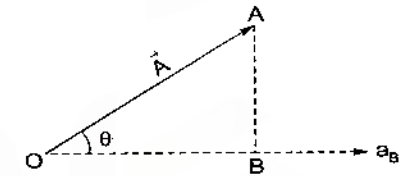

Cylindrical Coordinate System (r, phi, z)

In this system any point (r, phi, z) is represented by the intersection of three mutually orthogonal surfaces. The surface being circular cylinder of radius r = constant, a plane phi = constant (made by shifting xz plane by angle phi from y = 0 plane) and z = constant plane.

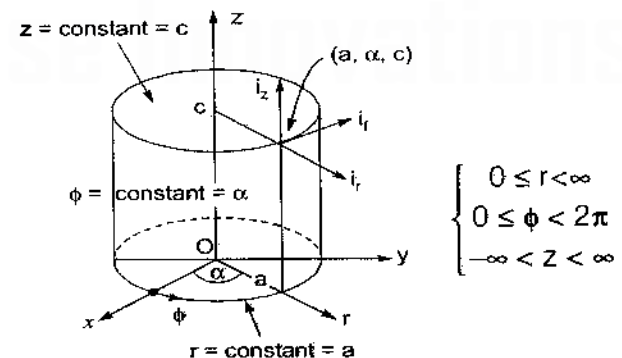

Note:

- i_r, i_ϕ and i_z are the mutually perpendicular unit vector drawn at a point P (r, ϕ, z).

1. Position vector of an arbitrary point P(r, ϕ, z)

$$\vec{r} = r i_r + z i_z$$

2. Displacement vector

$$d\vec{l} = dr i_r + r d\phi i_\phi + dz i_z$$

$$|d\vec{l}| = \sqrt{(dr)^2 + (rd\phi)^2 + (dz)^2}$$

(i) Differential length elements

$$dr i_r, r d\phi i_\phi, dz i_z$$

(ii) Differential normal surface areas

$$d\vec{S} = r d\phi dz i_r = dr dz i_\phi = r d\phi dr i_z$$

(iii) Differential volume

$$dV = r dr \cdot d\phi \cdot dz$$

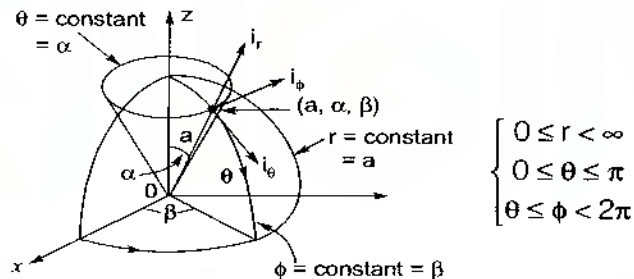
Spherical coordinate systems (r, θ, ϕ)

$$\begin{cases} 0 \leq r < \infty \\ 0 \leq \theta \leq \pi \\ \theta \leq \phi < 2\pi \end{cases}$$

i_r, i_θ and i_ϕ are the mutually perpendicular unit vectors drawn at a point P(r, θ, ϕ)

1. Position vector of an arbitrary point P

$$\vec{r} = r i_r$$

2. Displacement vector

$$d\vec{l} = dr i_r + r d\theta i_\theta + r \sin\theta d\phi i_\phi$$

$$|d\vec{l}| = \sqrt{(dr)^2 + (rd\theta)^2 + (r \sin\theta d\phi)^2}$$

(i) Differential length elements

$$dr i_r, r d\theta i_\theta, r \sin\theta d\phi i_\phi$$

(ii) Differential normal surface areas

$$d\vec{S} = r^2 \sin\theta d\theta d\phi i_r = r \sin\theta dr d\phi i_\theta = r dr d\theta i_\phi$$

(iii) Differential volume

$$dV = r^2 \sin\theta dr d\theta d\phi$$

Relationships Between Different Sets of Coordinates

	Cartesian x, y, z	Cylindrical r, ϕ, z	Spherical r, θ, ϕ
Cartesian x, y, z	—	$x = r \cos\phi$ $y = r \sin\phi$ $z = z$	$x = r \sin\theta \cos\phi$ $y = r \sin\theta \sin\phi$ $z = r \cos\theta$
Cylindrical r, ϕ, z	$r = \sqrt{x^2 + y^2}$ $\phi = \tan^{-1} \frac{y}{x}$ $z = z$	—	$r_c = r_s \sin\phi$ $\phi = \phi$ $z = r \cos\theta$
Spherical r, θ, ϕ	$r = \sqrt{x^2 + y^2 + z^2}$ $\theta = \tan^{-1} \frac{\sqrt{x^2 + y^2}}{z}$ $\phi = \tan^{-1} \frac{y}{x}$	$r_s = \sqrt{r_c^2 + z^2}$ $\theta = \tan^{-1} \frac{r_c}{z}$ $\phi = \phi$	—

In above table r_c 's for cylindrical coordinate system and r_s for spherical coordinate system.

Special Derivatives**Del (∇) operator**

Del is differential operator, which is a vector and can be given by

(i) In Cartesian coordinate system

$$\nabla = \frac{\partial}{\partial x} i_x + \frac{\partial}{\partial y} i_y + \frac{\partial}{\partial z} i_z$$

(ii) In cylindrical coordinate system

$$\vec{\nabla} = \frac{\partial}{\partial r} i_r + \frac{1}{r} \frac{\partial}{\partial \phi} i_\phi + \frac{\partial}{\partial z} i_z$$

(iii) In spherical coordinate system

$$\vec{\nabla} = \frac{\partial}{\partial r} i_r + \frac{1}{r} \frac{\partial}{\partial \theta} i_\theta + \frac{1}{r \sin \theta} \frac{\partial}{\partial \phi} i_\phi$$

Gradient of a Scalar field

- Gradient is an operation performed on a scalar function which results a vector function.
- The magnitude of this vector function represents the rate of change of scalar quantity w.r.t. various coordinates.
- The direction represents the direction in which this rate of change is maximum.

$$\vec{A} = \vec{\nabla} V$$

where, V is said to be the scalar potential of \vec{A}

(i) In Cartesian coordinate system

$$\vec{\nabla} V = \frac{\partial V}{\partial x} i_x + \frac{\partial V}{\partial y} i_y + \frac{\partial V}{\partial z} i_z$$

(ii) In cylindrical coordinate system

$$\vec{\nabla} V = \frac{\partial V}{\partial r} i_r + \frac{1}{r} \frac{\partial V}{\partial \phi} i_\phi + \frac{\partial V}{\partial z} i_z$$

(iii) In spherical coordinate system

$$\vec{\nabla} V = \frac{\partial V}{\partial r} i_r + \frac{1}{r} \frac{\partial V}{\partial \theta} i_\theta + \frac{1}{r \sin \theta} \frac{\partial V}{\partial \phi} i_\phi$$

Note:

Gradient of vector quantity is not possible

Divergence of a Vector

The divergence of a vector field A at a point P is the net outward flux of A per unit volume as the volume about the point tends to zero.

$$\text{Div. } \vec{A} = \vec{\nabla} \cdot \vec{A} = \lim_{\Delta V \rightarrow 0} \frac{\oint_s \vec{A} \cdot d\vec{S}}{\Delta V}$$

where, A = vector quantity
 ΔV = infinitesimal volume
 S = closed surface
 $d\vec{S}$ = infinitesimal area

(i) In Cartesian coordinate system

$$\vec{\nabla} \cdot \vec{A} = \frac{\partial A_x}{\partial x} + \frac{\partial A_y}{\partial y} + \frac{\partial A_z}{\partial z}$$

(ii) In cylindrical coordinate system

$$\vec{\nabla} \cdot \vec{A} = \frac{1}{r} \frac{\partial}{\partial r} (r \cdot A_r) + \frac{1}{r} \frac{\partial A_\phi}{\partial \phi} + \frac{\partial A_z}{\partial z}$$

(iii) In spherical coordinate system

$$\vec{\nabla} \cdot \vec{A} = \frac{1}{r^2} \frac{\partial}{\partial r} (r^2 \cdot A_r) + \frac{1}{r \sin \theta} \frac{\partial}{\partial \theta} (\sin \theta A_\theta) + \frac{1}{r \sin \theta} \frac{\partial A_\phi}{\partial \phi}$$

Note:

- Divergence of a vector is a scalar.
- Concept of divergence is valid at a point only
- Divergence of scalar is not possible

Properties of divergence of a vector field

- (i) $\nabla \cdot (A + B) = \nabla \cdot A + \nabla \cdot B$
(ii) $\nabla \cdot (VA) = V \nabla \cdot A + A \cdot \nabla V$

Curl of a vector field

The rate of change of a vector field is also known as curl which means circular rotation. Curl of a vector is another vector.

Curl of a vector A

$$\vec{\nabla} \times \vec{A} = \lim_{\Delta S \rightarrow 0} \frac{\oint_{\Delta C} \vec{A} \cdot d\vec{l}}{\Delta S} i_n$$

where, ΔS = infinitesimal area
 ΔC = periphery

Note:

- As the divergence of a vector is associated with a point in space, the curl of a vector is also associated with a point in space.
- Curl of a vector must have same axis of rotation.

Properties of the Curl

- (a) $\nabla \times (A + B) = \nabla \times A + \nabla \times B$
 (b) $\nabla \times (\nabla A) = \nabla \nabla \times A + \nabla \nabla \times A$

Important identities involving Curl

- (a) $\nabla \cdot (\nabla \times A) = 0$
 (b) $\nabla \times (\nabla A) = 0$

(i) Curl in rectangular coordinate

$$\text{Curl } \vec{A} = \vec{\nabla} \times \vec{A} = \begin{vmatrix} i_x & i_y & i_z \\ \frac{\partial}{\partial x} & \frac{\partial}{\partial y} & \frac{\partial}{\partial z} \\ A_x & A_y & A_z \end{vmatrix}$$

(ii) Curl in cylindrical coordinate

$$\vec{\nabla} \times \vec{A} = \begin{vmatrix} i_r & i_\phi & i_z \\ \frac{\partial}{\partial r} & \frac{\partial}{\partial \phi} & \frac{\partial}{\partial z} \\ A_r & A_\phi & A_z \end{vmatrix}$$

(iii) Curl in spherical coordinate

$$\vec{\nabla} \times \vec{A} = \begin{vmatrix} i_r & i_\theta & i_\phi \\ \frac{\partial}{\partial r} & \frac{\partial}{\partial \theta} & \frac{\partial}{\partial \phi} \\ A_r & rA_\theta & r \sin\theta A_\phi \end{vmatrix}$$

Remember:

- Divergence of Curl is always zero i.e. $[\vec{\nabla} \cdot (\vec{\nabla} \times \vec{A})] = 0$.
- Curl of gradient is always zero i.e. $[\vec{\nabla} \times (\vec{\nabla} \cdot \vec{A})] = 0$.
- A vector \vec{A} is solenoidal if its divergence is zero.
- A vector \vec{A} is irrotational if its curl is zero.
- Curl is also known as cross product.

Laplacian (∇^2)

Laplacian operation can be performed both on scalar and vector function.

1. Laplacian of Scalar

$$\text{Laplacian } V = \nabla^2 V = \nabla \cdot \nabla V$$

- A scalar field V is said to be harmonic in a given region if its Laplacian vanishes in that region.

$$\nabla^2 V = 0$$

(i) In Cartesian coordinate system

$$\nabla^2 V = \frac{\partial^2 V}{\partial x^2} + \frac{\partial^2 V}{\partial y^2} + \frac{\partial^2 V}{\partial z^2}$$

(ii) In Cylindrical coordinate system

$$\nabla^2 V = \frac{1}{r} \frac{\partial}{\partial r} \left(r \frac{dV}{dr} \right) + \frac{1}{r^2} \frac{\partial^2 V}{d\phi^2} + \frac{\partial^2 V}{dz^2}$$

(iii) In Spherical coordinate system

$$\nabla^2 V = \frac{1}{r^2} \frac{\partial}{\partial r} \left(r^2 \frac{\partial V}{\partial r} \right) + \frac{1}{r^2 \sin\theta} \frac{\partial}{\partial \theta} \left(\sin\theta \frac{\partial V}{\partial \theta} \right) + \frac{1}{r^2 \sin^2\theta} \left(\frac{\partial^2 V}{\partial \phi^2} \right)$$

2. Laplacian of vector

- The Laplacian of vector A is

$$\vec{\nabla}^2 \vec{A} = \vec{\nabla} (\vec{\nabla} \cdot \vec{A}) - \vec{\nabla} \times \vec{\nabla} \times \vec{A}$$

Remember:

- The Laplacian of a scalar field V is the divergence of the gradient of V .
- Laplacian of a scalar results in a scalar

Divergence Theorem

"The volume integral of the divergence of vector field A is taken over any volume V is equal to the surface integral of A taken over the closed surface (total outward flux of the vector through the surface) surrounding the volume V ."

$$\int_V (\nabla \cdot \vec{A}) dV = \oint_S \vec{A} \cdot d\vec{S}$$

Note:

The divergence theorem applies to any volume V that is bounded by surface S .

Stoke's Theorem

"The circulation of vector field A around a closed path L is equal to the surface integral of the Curl of A over the open surface S bounded by L , provided A and $\nabla \times A$ are continuous on S ."

$$\int_S (\nabla \times \vec{A}) \cdot d\vec{S} = \oint_L \vec{A} \cdot d\vec{l}$$

**Electrostatics****3****Source of Charges****1. Point Charge**

If charge is put at a point only $\bullet +Q$

2. Line charge density

It is charge per unit length.

$$\frac{dQ}{dL} = \rho_L \quad \text{C/m}$$

$$Q = \int_L \rho_L dL \quad \text{C}$$

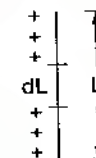
**3. Surface charge density**

It is the charge per unit area

$$\frac{dQ}{dS} = \rho_S \quad \text{C/m}^2$$

$$Q = \iint_S \rho_S dS \quad \text{C}$$

**4. Volume charge density**

It is the charge per unit volume

$$\frac{dQ}{dV} = \rho_V \quad \text{C/m}^3$$

$$Q = \iiint_V \rho_V dV \quad \text{C}$$

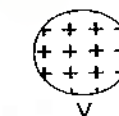
**Charge in terms of Various Charge Distributions**

$$Q = \int_L \rho_L dL = \int_S \rho_S dS = \int_V \rho_V dV \quad \text{C}$$

where, ρ_L , ρ_S and ρ_V are line charge, surface charge and volume charge density respectively.

Coulomb's Law

The force acting between two point charges is directly proportional to the products of charges and inversely proportional to the square of the distance between them

$$Q_1 \times \xrightarrow{R} \times Q_2$$

$$F \propto \frac{Q_1 Q_2}{R^2} \text{ Newton}$$

$$F = K \cdot \frac{Q_1 Q_2}{R^2} = \frac{Q_1 Q_2}{4\pi \epsilon_0 R^2}$$

Where, $K = \frac{1}{4\pi \epsilon_0} = 9 \times 10^9$ in S.I. system

- If two same positive charge are placed then they experience a repulsive force.

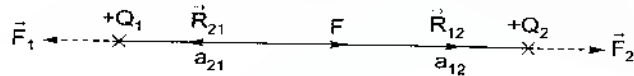

$$a_{12} = \frac{\vec{R}_{12}}{|\vec{R}_{12}|} \text{ and } a_{21} = \frac{\vec{R}_{21}}{|\vec{R}_{21}|}$$

$$\vec{R}_{12} = -\vec{R}_{21} \text{ and } a_{12} = -a_{21}$$

$$\vec{F}_1 = \frac{Q_1 Q_2}{4\pi \epsilon_0 R_{21}^2} a_{21}, \quad \vec{F}_2 = \frac{Q_1 Q_2}{4\pi \epsilon_0 R_{12}^2} a_{12}$$

$$\vec{F}_1 = -\vec{F}_2$$

Note:

- Linear forces are another property of Coulomb force i.e. $nF \propto nQ_1 Q_2$
- Coulomb's force obeys law of superposition.
- Coulomb's forces are called mutual and linear force.

Electric Field Intensity

The electric field intensity or electric field strength (E) is the force per unit charge when placed in an electric field

$$E = \lim_{Q \rightarrow 0} \frac{\vec{F}}{Q} \text{ Newton/C}$$

Electric field due to continuous charge distribution

(i) Line charge

$$E = \int_L \frac{\rho_L dL}{4\pi \epsilon_0 R^2} a_r$$

(ii) Surface charge

$$E = \int_S \frac{\rho_S dS}{4\pi \epsilon_0 R^2} a_r$$

(iii) Volume charge

$$E = \int_V \frac{\rho_V dV}{4\pi \epsilon_0 R^2} a_r$$

Electric field intensity due to infinitely long line charge

$$E = \frac{\rho_L}{2\pi \epsilon_0 r} a_r$$

where, ρ_L = Charge per unit length
= Line charge density C/m

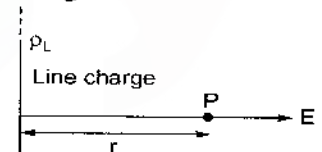
**Electric field intensity due to infinite charge sheet**

$$E = \frac{\rho_S}{2 \epsilon_0} i_n$$

where, ρ_S = Surface charge density, C/m²
If sheet is on xy plane $z = z_0$

$$E = \begin{cases} \frac{\rho_S}{2 \epsilon_0} i_z & \text{for } z > z_0 \\ -\frac{\rho_S}{2 \epsilon_0} i_z & \text{for } z < z_0 \end{cases}$$

Remember:

- In a parallel plate capacitor, the electric field existing between the two plates having equal and opposite charges

$$E = \frac{\rho_S}{\epsilon_0} i_n$$

Electric field intensity due to uniformly charged sphere

$$E = \begin{cases} \frac{r}{3\epsilon_0} \rho_0 \hat{i}_r; & 0 < r \leq a \\ \frac{a^3}{3\epsilon_0 r^2} \rho_0 \hat{i}_r; & r \geq a \end{cases}$$

Where ρ_0 = Volume charge density
 a = Radius of sphere

Electric/Displacement Flux Density

The electric flux density is always tangential to electric flux lines. Electric flux lines originates from a positive charge and ends on a negative charge.

$$D = \frac{\text{Flux}}{\text{Unit area}}$$

$$\vec{D} = \frac{Q}{4\pi r^2} \hat{i}_r \quad \text{and} \quad \vec{E} = \frac{Q}{4\pi \epsilon_0 r^2} \hat{i}_r$$

$$\vec{D} = \epsilon_0 \vec{E}$$

where, \vec{D} = Electric flux density C/m²

\vec{E} = Electric field intensity V/m

ϵ = Electrical permittivity of medium

$$\epsilon = \epsilon_0 \epsilon_r$$

ϵ_0 = Free space permittivity

$$= 8.854 \times 10^{-12} \text{ F/m} = \left(\frac{1}{36\pi}\right) \times 10^{-9} \text{ F/m}$$

ϵ_r = Relative permittivity or Dielectric constant of medium

$\epsilon_r = 1$ (For air (or) free space)

$\epsilon_r > 1$ (For rest of the material)

Note:

Electric field \vec{E} depends upon the medium whereas \vec{D} is independent of the medium.

Gauss's Law

Gauss law states that flux leaving any closed surface is equal to the charge enclosed by that surface.

$$\psi = \oint_S \vec{D} \cdot d\vec{S} = Q = \int_V \rho_V \cdot dV \quad \dots \text{ Gauss law in integral form}$$

$$\rho_V = \nabla \cdot \vec{D} \quad \dots \text{ Gauss law in differential or point form Maxwell's first equation.}$$

Note:

- The Gauss law is applicable for time varying as well as static fields.
- The equation is valid irrespective of the shape of closed surface area 'S'.

Electrical Energy Density

It is total electrical per unit volume

$$W_e = \frac{1}{2} \epsilon \vec{E}^2 = \frac{1}{2} \vec{D} \cdot \vec{E} \quad \text{J/m}^3$$

Total electrical energy stored

$$W_e = \frac{1}{2} CV^2 = \frac{1}{2} QV = \frac{1}{2} \frac{Q^2}{C}$$

Energy Density in Electrostatic Field**Electrostatic energy density**

$$W_E = \frac{dW_E}{dv} = \frac{1}{2} \vec{D} \cdot \vec{E} = \frac{1}{2} \epsilon_0 E^2 = \frac{D^2}{2\epsilon_0}$$

Total electrostatic energy

$$W_E = \frac{1}{2} \int_V \vec{D} \cdot \vec{E} dV = \frac{1}{2} \int_V \epsilon_0 E^2 dV$$

Electric Potential

Potential difference

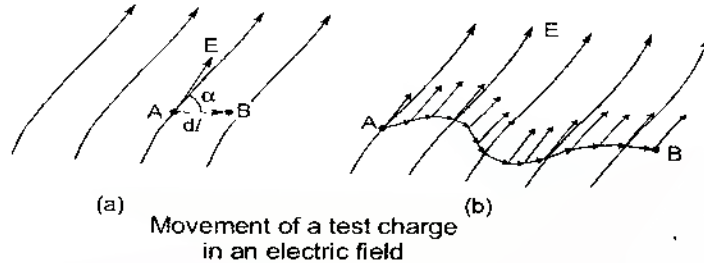

$$V_{AB} = \frac{Q}{4\pi\epsilon_0} \left[\frac{1}{r_B} - \frac{1}{r_A} \right] ; \quad V_{AB} = \frac{W_{AB}}{q} = - \int_A^B \vec{E} \cdot d\vec{l}$$

where, V_{AB} = Potential difference between the points A & B
 W_{AB} = Work done by the field in moving a test charge q from A to B
 $d\vec{l}$ = Infinitesimal length of segments

Remember:

- The negative sign in above equation indicates that the work is being done by an external agent.
- If V_{AB} is negative, there is a loss in potential energy in moving charge Q from A to B i.e. the field does the work.

Potential at a point P due to point charge

$$V(r) = \int_r^\infty \vec{E} \cdot d\vec{l} = - \int_\infty^r \vec{E} \cdot d\vec{l} \quad \text{Volt}$$

where, $V(r)$ = Potential at a distance r from the point charge
 r = distance of point P from point charge

$$V = \frac{Q}{4\pi\epsilon_0 r}$$

For static electric field

$$\oint \vec{E} \cdot d\vec{l} = 0 ; \quad \nabla \times \vec{E} = 0$$

Remember:

The potential at any point is the potential difference between that point and a chosen point (or reference point) at which the potential is zero.

Relation between electric field intensity vector and potential at a point

$$\vec{E} = - \nabla V$$

Poisson's and Laplace Equation

$$\nabla^2 V = \frac{-\rho_v}{\epsilon} \quad \dots \text{Poisson's equation}$$

For charge free region $\rho_v = 0$

$$\nabla^2 V = 0 \quad \dots \text{Laplace equation}$$

- In Poisson's equation the potential or electric field can be found due to specified volume charge distribution in the given region.
- In Laplace equation the potential or electric field can be found in the charge free region.

Remember:

- Both Poisson's and Laplace equation are second order three dimensional non linear differential equations.
- Poisson's equation is valid in the region where some charge is present, where as Laplace equation is valid for charge free region.
- At least two boundary conditions must be known to calculate two arbitrary constants of integration when the two equations are solved.

Electric Dipole

An electric dipole is formed when two point charges of equal magnitude but opposite sign are separated by small distance

Dipole moment

$$\vec{p} = Q\vec{d}$$

Direction of dipole moment \vec{p} is from negative charge to positive charge.

Electric field intensity due to electric dipole

$$\vec{E} = \frac{Qd}{4\pi\epsilon_0 r^3} (2 \cos\theta \vec{i}_r + \sin\theta \vec{i}_\theta)$$

$$\vec{E} = \frac{p}{4\pi\epsilon_0 r^3} (2 \cos\theta \vec{i}_r + \sin\theta \vec{i}_\theta)$$

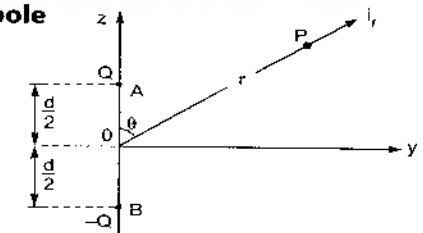

Conductor

A perfect conductor ($\sigma = \infty$) cannot contain an electrostatic field within it.

Inside a conductor

$$E = 0, \rho_v = 0, V_{ab} = 0$$

where, V_{ab} = Potential difference between points a and b in the conductor.

Power

Joule's law

$$P = \int_v \vec{E} \cdot \vec{J} dV$$

where, J = Current density, A/m^2

Continuity Equation

$$\nabla \cdot J = -\frac{\partial \rho_v}{\partial t}$$

Note:

- For steady current $\frac{\partial \rho_0}{\partial t} = 0$.
- For lossless region $\rho_v = 0; \nabla \cdot J = 0$.

Boundary Conditions

Dielectric-Dielectric Boundary Condition

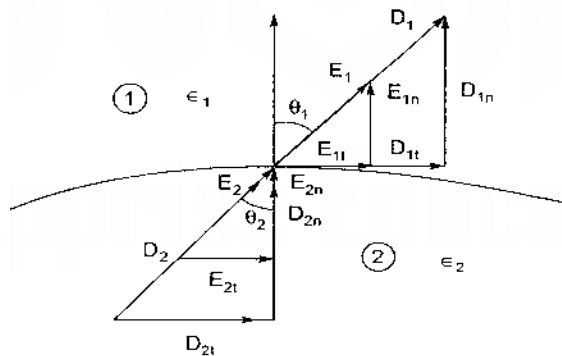

$$\vec{E}_1 = \vec{E}_{1t} + \vec{E}_{1n} \quad \text{and} \quad \vec{E}_2 = \vec{E}_{2t} + \vec{E}_{2n}$$

where, \vec{E}_1, \vec{E}_2 = Fields in media 1 and 2 respectively
 \vec{E}_t, \vec{E}_n = Tangential and normal components of E

Tangential component relation

$$\vec{E}_{1t} = \vec{E}_{2t} \quad \text{or} \quad \frac{\vec{D}_{1t}}{\epsilon_1} = \frac{\vec{D}_{2t}}{\epsilon_2}$$

Normal component relation

$$\vec{D}_{1n} - \vec{D}_{2n} = \rho_s$$

where, ϵ_1 & ϵ_2 = Permittivity of dielectric 1 and 2

ρ_s = Free charge density placed deliberately at the boundary

Remember:

- The tangential component of \vec{E} is continuous while that of \vec{D} is discontinuous at boundary.
- The normal component of \vec{D} is continuous while that of \vec{E} is discontinuous at boundary.

If no free charges exists at the interface

$$\vec{D}_{1n} = \vec{D}_{2n} \quad \text{or} \quad \epsilon_1 \vec{E}_{1n} = \epsilon_2 \vec{E}_{2n}$$

$$\frac{\tan \theta_1}{\tan \theta_2} = \frac{\epsilon_1}{\epsilon_2}$$

Conductor-Dielectric Boundary Conditions.

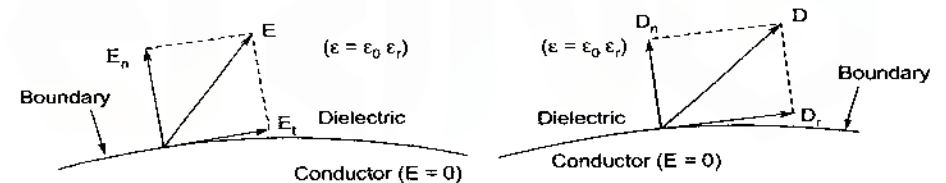

$$\vec{D}_t = \epsilon \vec{E}_t = 0 \quad \text{and} \quad \vec{D}_n = \epsilon \vec{E}_n = \rho_s$$

Remember:

- Since $\vec{E} = -\nabla V = 0$, there can be no potential difference between any two points in the conductor (i.e. a conductor is an equipotential body).
- An electric field E must be external to the conductor and must be normal to its surface.

$$\vec{D}_t = \epsilon \vec{E}_t = 0 \quad \text{and} \quad \vec{D}_n = \epsilon \vec{E}_n = \rho_s$$



Magnetostatic Field



Biot-Savart's Law

The Biot-Savart's law states that the differential magnetic field intensity dH produced at a point P , by the differential current element Idl is proportional to the product Idl and the sine of the angle θ between the element and the line joining P to the element and is inversely proportional to the square of the distance R between P and the element.

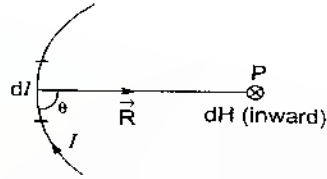

$$dH \propto \frac{Idl \sin \alpha}{R^2} \text{ A/m}$$

$$dH = \frac{Idl \times a_r}{4\pi R^2} = \frac{Idl \times \vec{R}}{4\pi |\vec{R}|^3}$$

$$H = \oint \frac{Idl \times a_r}{4\pi R^2} \text{ A/m}$$

where, a_r = unit vector pointing from the different element of current to the point of interest.

Magnetic Field Intensity for Distributed Current Source

(i) Line current

$$\vec{H} = \int_L \frac{Idl \times a_r}{4\pi R^2}$$

(ii) Surface current

$$\vec{H} = \int_S \frac{K \cdot dS \times a_r}{4\pi R^2}$$

where, K = surface current density

(ii) Volume current

$$\vec{H} = \int_V \frac{J_v \cdot dV \times a_r}{4\pi R^2}$$

where, J = volume current density

Magnetic field intensity due to straight current carrying filamentary conductor

(i) Finite length AB

$$\vec{H} = \frac{I}{4\pi\rho} (\cos \alpha_2 - \cos \alpha_1) a_\phi$$

(ii) Semi-infinite length

$$\vec{H} = \frac{I}{4\pi\rho} a_\phi$$

(iii) Infinite length

$$\vec{H} = \frac{I}{2\pi\rho} a_\phi$$

$$a_\phi = a_l \times a_p$$

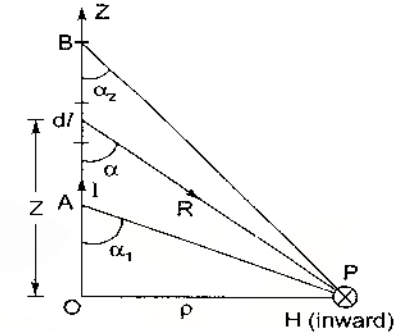

where, a_l is unit vector along the line current and a_p is unit vector along the perpendicular line from the line current to the field point.

Ampere's Circuit Law

The closed line integral of static magnetic field intensity \vec{H} , integrated over any closed curve 'C' is always equal to total current enclosed within the closed curve 'C'.

$$\oint \vec{H} \cdot d\vec{l} = I_{enc} \text{ A}$$

$$\oint \vec{H} \cdot d\vec{l} = \iiint \vec{J} \cdot d\vec{S} \text{ Ampere's circuit law in the integral form}$$

• The Curl of static magnetic field intensity \vec{H} at any point in the electromagnetic region is equal to volume current density \vec{J} present at that point.

$$\nabla \times \vec{H} = \vec{J} \text{ Ampere's circuit law in point form of differential form}$$

Note:

- $\nabla \times \vec{H} = \vec{J}$ is the also known as Maxwell's third equation.
- Ampere's circuit law is applicable irrespective of shape of the closed curve 'C'.
- The magnetostatic field is not conservative as $\nabla \times H = J \neq 0$.

Magnetic Field Intensity Due to Infinite Line Current

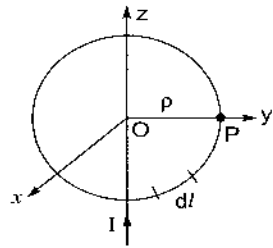

$$\vec{H} = \frac{1}{2\pi\rho} a_\phi$$

Magnetic Field Intensity Due to Infinite Sheet of Current

$$\vec{H} = \frac{1}{2} \vec{K} \times a_n$$

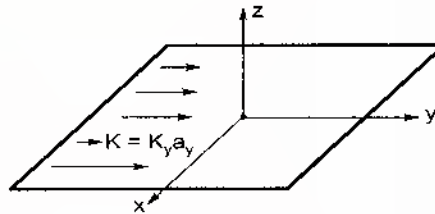

where, a_n = Unit normal
 K = uniform current density

$$H = \begin{cases} \frac{1}{2} K_y a_x; & z > 0 \\ -\frac{1}{2} K_y a_x; & z < 0 \end{cases}$$

Magnetic Flux Density

$$\vec{B} = \mu_0 \vec{H} \text{ Wb/m}^2$$

where, μ_0 = permeability of free space.

Magnetic flux through a surface S

$$\psi = \int_S \vec{B} \cdot d\vec{S} \text{ Wb}$$

Remember:

- An isolated magnetic charge does not exist. Thus the total flux through a closed surface in a magnetic field must be zero.

$$\oint \vec{B} \cdot d\vec{S} = 0$$

Maxwell's fourth equation: $\nabla \cdot \vec{B} = 0$

Magnetic Energy Density (W_m)

The magnetic energy density represents magnetic energy stored at a point in the electro magnetic region and gives total magnetic energy per unit volume of the given configuration.

$$W_m = \frac{1}{2} \mu H^2 = \frac{1}{2} \vec{B} \cdot \vec{H}$$

Magnetic Energy

$$W_m = \iiint_V W_m dV = \frac{1}{2} L I^2 \text{ Joule}$$

Remember:

The magnetic energy density depends upon

- Magnetic field due to given current distribution in the configuration.
- Permeability of the magnetic medium.

Magnetic Scalar and Vector Potentials

The magnetic potential could be scalar V_m or vector \vec{A}

Magnetic scalar potential (V_m)

The magnetic scalar potential is only defined in a region where $J = 0$.

$$\vec{H} = -\nabla V_m$$

Vector Magnetic Potential \vec{A}

$$\vec{B} = \nabla \times \vec{A}$$

For line current

$$A = \int_L \frac{\mu_0 I dl}{4\pi R} \text{ Wb/m}$$

For surface current

$$A = \int_S \frac{\mu_0 K dS}{4\pi R}$$

For volume current

$$A = \int_V \frac{\mu_0 J dV}{4\pi R}$$

Remember:

Important identities which must always hold for any scalar field V and vector field \vec{A} .

$$\nabla \times (\nabla V) = 0 \quad \text{and} \quad \nabla \cdot (\nabla \times \vec{A}) = 0$$

Forces Due to Magnetic Field

Force on a Charged Particle

(i) Magnetic force

$$\vec{F}_m = Q(\vec{u} \times \vec{B}) \quad \text{Newton}$$

where, u = Velocity of moving charge Q
 B = Magnetic field

(ii) Electric force

$$\vec{F}_e = QE$$

where, Q = electric charge ; E = electric field intensity

Lorentz force equation

For a moving charge Q in the presence of both electric and magnetic fields

$$\vec{F} = \vec{F}_e + \vec{F}_m = Q(\vec{E} + \vec{u} \times \vec{B})$$

Force on a Current Element

Force on a current carrying conductor

The magnetic field is defined as the force per unit current element.

$$\vec{F} = \int_L Id\vec{l} \times \vec{B}$$

where $Id\vec{l}$ = Current element of current carrying conductor

Magnetic Torque and Magnetic Moment

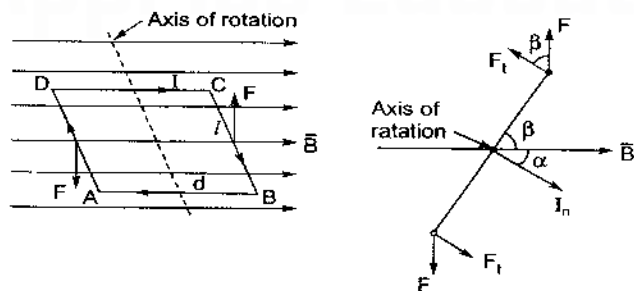

Magnetic Torque

$$\tau = BIS \sin \alpha$$

where, S = area of the loop

$$\vec{\tau} = \vec{m} \times \vec{B}$$

Magnetic Dipole Moment

$$\vec{m} = IS\vec{i}_n$$

Magnetic Boundary Conditions

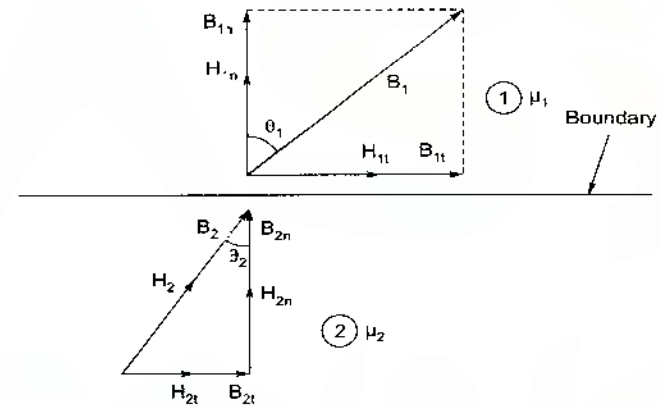

Tangential component relation

$$\vec{H}_{1t} = \vec{H}_{2t} \quad \text{or} \quad \frac{\vec{B}_{1t}}{\mu_1} = \frac{\vec{B}_{2t}}{\mu_2}$$

Normal component relation

$$\vec{B}_{1n} = \vec{B}_{2n} \quad \text{or} \quad \mu_1 \vec{H}_{1n} = \mu_2 \vec{H}_{2n}$$

Remember:

- The tangential component of H is continuous while that of B is discontinuous at boundary.
- The normal component of B is continuous while that of H is discontinuous at boundary.

$$\frac{\tan \theta_1}{\tan \theta_2} = \frac{\mu_1}{\mu_2}$$

Maxwell's Equations

5

Introduction

- Stationary charges → Electrostatic field
- Steady currents → Magnetostatic field
- Time-varying currents → Electromagnetic field (or waves)

Faraday's Law

- The induced emf (V_{emf}), in any closed circuit is equal to the time rate of change of the magnetic flux linkage by the circuit

$$V_{emf} = - \frac{d\lambda}{dt} = -N \frac{d\psi}{dt}$$

where, λ = flux linkage
 N = number of turns in the circuit
 ψ = flux through each turn

- The negative sign shows that the induced voltage acts in such a way as to oppose the flux producing it.

Transformer and motional Electromotive Forces

Stationary loop in time-varying magnetic field

(i) Transformer emf

$$V_{emf} = \oint_L \vec{E} \cdot d\vec{l} = - \frac{d}{dt} \int_S \vec{B} \cdot d\vec{S}$$

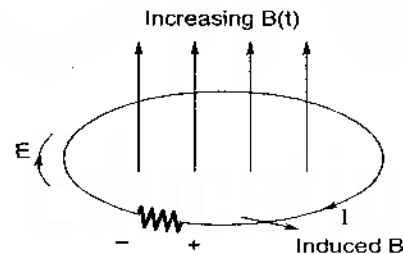

(ii) Maxwell's equation for time-varying field

$$\nabla \times \vec{E} = - \frac{\partial \vec{B}}{\partial t}$$

Note:

Time varying electric field E is not conservative ($\nabla \times E \neq 0$).

Moving loop in static magnetic field

(i) Motional electric field

$$\vec{E}_m = \frac{\vec{F}_m}{Q} = \vec{u} \times \vec{B}$$

where, F_m = Force on charge moving with uniform Velocity u , in a magnetic field

(ii) Motional emf or flux-cutting emf

$$V_{emf} = \oint_L \vec{E}_m \cdot d\vec{l} = \oint_L (\vec{u} \times \vec{B}) \cdot d\vec{l}$$

Moving loop in time-varying field

$$V_{emf} = \oint_L \vec{E} \cdot d\vec{l} = - \int_S \frac{\partial \vec{B}}{\partial t} \cdot d\vec{S} + \oint_L (\vec{u} \times \vec{B}) \cdot d\vec{l}$$

$$\nabla \times \vec{E} = - \frac{\partial \vec{B}}{\partial t} + \nabla \times (\vec{u} \times \vec{B})$$

Displacement Current

Displacement current density

$$\vec{J}_d = \frac{\partial \vec{D}}{\partial t}$$

Maxwell's Equations in Final Forms

Maxwell's equation for static electric and magnetic fields

Differential (or Point form)	Integral Form	Remarks
$\nabla \cdot \vec{D} = \rho_v$	$\oint_S \vec{D} \cdot d\vec{S} = \int_V \rho_v dv$	Gauss's law
$\nabla \cdot \vec{B} = 0$	$\oint_S \vec{B} \cdot d\vec{S} = 0$	Nonexistence of magnetic monopole
$\nabla \times \vec{E} = 0$	$\oint_L \vec{E} \cdot d\vec{l} = 0$	Conservative of electrostatic field
$\nabla \times \vec{H} = \vec{J}$	$\oint_L \vec{H} \cdot d\vec{l} = \int_S \vec{J} \cdot d\vec{S}$	Ampere's Law

Maxwell's equation for time-varying field

Differential Form	Integral Form	Remarks
$\nabla \cdot \vec{D} = \rho_v$	$\oint_S \vec{D} \cdot d\vec{S} = \int_V \rho_v dv$	Gauss's law
$\nabla \cdot \vec{B} = 0$	$\oint_S \vec{B} \cdot d\vec{S} = 0$	Non-existence of isolated magnetic charge
$\nabla \times \vec{E} = -\frac{\partial \vec{B}}{\partial t}$	$\oint_L \vec{E} \cdot d\vec{l} = -\frac{\partial}{\partial t} \int_S \vec{B} \cdot d\vec{S}$	Faraday's law
$\nabla \times \vec{H} = \vec{J} + \frac{\partial \vec{D}}{\partial t}$	$\oint_L \vec{H} \cdot d\vec{l} = \int_S \left(\vec{J} + \frac{\partial \vec{D}}{\partial t} \right) \cdot d\vec{S}$	Ampere's circuit law

Time-Varying Potentials

$$\vec{E} = -\nabla V - \frac{\partial \vec{A}}{\partial t}$$

Lorentz condition for potentials

$$\nabla \cdot \vec{A} = -\mu \epsilon \frac{\partial V}{\partial t}$$

Time Harmonic Field

- A time harmonic field is one that varies periodically or sinusoidally with time.
- Phasor form of vector A is $A_s(x, y, z)$

$$\vec{A} = \text{Re} \{ A_s e^{j\omega t} \}$$

Maxwell's equation for time harmonic field

Point Form	Integral Form
$\nabla \cdot \vec{D}_s = \rho_{vs}$	$\oint_S \vec{D}_s \cdot d\vec{S} = \int_V \rho_{vs} dv$
$\nabla \cdot \vec{B}_s = 0$	$\oint_S \vec{B}_s \cdot d\vec{S} = 0$
$\nabla \times \vec{E}_s = -j\omega \vec{B}_s$	$\oint_L \vec{E}_s \cdot d\vec{l} = -j\omega \int_S \vec{B}_s \cdot d\vec{S}$
$\nabla \times \vec{H}_s = \vec{J}_s + j\omega \vec{D}_s$	$\oint_L \vec{H}_s \cdot d\vec{l} = \int_S (\vec{J}_s + j\omega \vec{D}_s) \cdot d\vec{S}$

■■■■

6

Electromagnetic Wave Propagation

Introduction

Waves are means of transporting energy or information. Some examples of EM waves are radio waves, TV signals, radar beams and light rays.

Remember:

Characteristics of EM medium:

- Free space : $\sigma = 0, \epsilon = \epsilon_0, \mu = \mu_0$.
- Perfect dielectric : $\sigma = 0, \epsilon$ and μ can have any value.
- Good dielectrics : $\sigma \approx 0, \epsilon = \epsilon_r \epsilon_0, \mu = \mu_r \mu_0$ or $\sigma \ll \omega \epsilon$.
- Perfect conducting : $\sigma = \infty, \epsilon$ and μ can have any value.
- Good conductor : $\sigma \approx \infty, \epsilon = \epsilon_0, \mu = \mu_r \mu_0$ or $\sigma \gg \omega \epsilon$.

Wave propagation in Lossy Dielectrics

A lossy dielectric is a medium in which an EM wave, as it propagates, loses power owing to imperfect dielectric. A lossy dielectric is a partially conducting medium.

Vector wave equation or vector Helmholtz's equation

(i) For E-field

$$\nabla^2 \vec{E}_s - \gamma^2 \vec{E}_s = 0$$

(ii) For H-field

$$\nabla^2 \vec{H}_s - \gamma^2 \vec{H}_s = 0$$

where,

γ = propagation constant of medium

$$\gamma = \alpha + j\beta \quad \text{and} \quad \gamma^2 = j\omega\mu(\sigma + j\omega\epsilon)$$

where,

α = Attenuation constant (Neper/m)

β = Phase constant (rad/m)

$$\alpha = \omega \sqrt{\frac{\mu \epsilon}{2} \left[\sqrt{1 + \left[\frac{\sigma}{\omega \epsilon} \right]^2} - 1 \right]}$$

$$\beta = \omega \sqrt{\frac{\mu \epsilon}{2} \left[\sqrt{1 + \left[\frac{\sigma}{\omega \epsilon} \right]^2} + 1 \right]}$$

Field equation of EM wave in s-domain

$$E_s(z) = E_0 e^{-\alpha z} e^{j(\omega t - \beta z)} a_x$$

$$H_s(z) = H_0 e^{-\alpha z} e^{j(\omega t - \beta z)} a_y$$

Field equation of EM wave in time domain

$$E(z, t) = E_0 e^{-\alpha z} \cos(\omega t - \beta z) a_x$$

$$H(z, t) = H_0 e^{-\alpha z} \cos(\omega t - \beta z) a_y$$

Intrinsic Impedance (η)

It is the ratio of electric field intensity to the corresponding magnetic field intensity for an electromagnetic wave.

where,

$$\eta = \frac{E}{H} \Omega$$

It is found to be independent of the location of measurement.

- It is a complex quantity

$$\eta = |\eta| e^{j\theta_\eta}$$

For general/Lossy medium

$$\eta = \sqrt{\frac{j\omega\mu}{\sigma + j\omega\epsilon}}$$

$$\text{where, } |\eta| = \frac{\sqrt{\mu/\epsilon}}{\left[1 + \left(\frac{\sigma}{\omega\epsilon} \right)^2 \right]^{1/4}}$$

$$\theta_n = \frac{1}{2} \tan^{-1} \left(\frac{\sigma}{\omega\epsilon} \right)$$

Phase Velocity

$$u = \frac{\omega}{\beta} = \frac{1}{\text{wave number}} = \frac{C}{\sqrt{\mu_r \epsilon_r}} \text{ m/s}$$

where,

u = wave velocity

C = Free space velocity

also,

$$\beta = \frac{2\pi}{\lambda}$$

where,

λ = Wavelength

Loss tangent/Dissipation factor

It is the ratio of conduction current density to the displacement current density and given by

$$\tan \delta = \frac{|\vec{J}_C|}{|\vec{J}_D|} = \frac{\sigma}{\omega \epsilon}$$

where,

δ = loss angle

Note:

If θ_η is intrinsic angle then the loss tangent is given by $\tan 2\theta_\eta$.

For Complex Permittivity

$$\epsilon_c = \epsilon' - j\epsilon'' = \epsilon \left[1 - j \frac{\sigma}{\omega \epsilon} \right]$$

where, $\epsilon' = \epsilon$ = real component of complex permittivity

$\epsilon'' = \sigma/\omega$ = imaginary component of permittivity

Loss tangent

$$\tan \delta = \frac{\epsilon''}{\epsilon'} = \frac{\sigma}{\omega \epsilon}$$

Plane Waves in Free Space

In free space

$$\sigma = 0, \epsilon = \epsilon_0, \mu = \mu_0$$

- $\alpha = 0, \beta = \omega \sqrt{\mu_0 \epsilon_0} = \frac{\omega}{c}$
- $u = \frac{1}{\sqrt{\mu_0 \epsilon_0}} = c; \lambda = \frac{2\pi}{\beta}$
- $\eta_0 = \sqrt{\frac{\mu_0}{\epsilon_0}} \approx 377 \Omega = 120\pi \Omega$

$$\vec{i}_E \times \vec{i}_H = \vec{i}_k$$

where \vec{i}_k = direction of wave propagation

Plane Waves in Lossless Dielectrics/Perfect Dielectric

In lossless dielectric

$$\sigma \ll \omega\epsilon$$

$$\sigma \simeq 0, \quad \epsilon = \epsilon_0\epsilon_r, \quad \mu = \mu_0\mu_r$$

- $\alpha = 0, \quad \beta = \omega\sqrt{\mu\epsilon}$
- $u = \frac{\omega}{\beta} = \frac{1}{\sqrt{\mu\epsilon}}, \quad \lambda = \frac{2\pi}{\beta}$
- $\eta = \sqrt{\frac{\mu}{\epsilon}} \angle 0^\circ = \eta_0 \sqrt{\frac{\mu_r}{\epsilon_r}} = 120\pi \sqrt{\frac{\mu_r}{\epsilon_r}}$
- E and H are in time phase with each other

Plane waves in Good Conductors

In good conductor

$$\sigma \gg \omega\epsilon$$

$$\sigma \simeq \infty, \quad \epsilon = \epsilon_0, \quad \mu = \mu_0\mu_r$$

- $\alpha = \beta = \sqrt{\frac{\omega\mu\sigma}{2}} = \sqrt{\pi f\mu\sigma}$
- $u = \frac{\omega}{\beta} = \sqrt{\frac{2\omega}{\mu\sigma}}, \quad \lambda = \frac{2\pi}{\beta}$
- $\eta = \sqrt{\frac{\omega\mu}{\sigma}} \angle 45^\circ$

Skin Depth

The skin depth is a measure of the depth to which the amplitude of an EM wave will reduce to 36.8% of initial value.

$$\delta = \frac{1}{\alpha} = \frac{1}{\sqrt{\pi f\mu\sigma}} \text{ meter}$$

Surface or Skin Resistance

$$R_s = \frac{1}{\sigma\delta} = \sqrt{\frac{\pi f\mu}{\sigma}} \Omega/m^2$$

Remember:

- The skin depth is useful in calculating the *ac* resistance due to skin effect.
- $\delta \propto \frac{1}{\sqrt{f}}$.
- The perfect dielectric medium behaves like a perfect transmitter of EM wave.
- The perfect conducting medium behaves like a perfect reflector of EM wave.

Poynting's Theorem

The theorem states that "the net power flowing out of a given volume V is equal to the sum of the Ohmic losses and the time rate of decrease in the energy stored within volume V."

$$-\oint_S (\vec{E} \times \vec{H}) \cdot d\vec{S} = \frac{\partial}{\partial t} \int_V \left[\frac{1}{2} \epsilon \vec{E}^2 + \frac{1}{2} \mu \vec{H}^2 \right] dV + \int_V \vec{J}_c \cdot \vec{E} dV$$

↓ Total Power leaving the volume
 ↓ Rate of decrease in energy stored in electric and magnetic fields
 ↓ Ohmic Power dissipated

Poynting Vector

$$\vec{P} = \vec{E} \times \vec{H} \text{ Watt/m}^2$$

Poynting vector represents the following parameter associated with the EM wave.

- Power density associated in EM wave in Watt/m²
- The power flow for the given EM wave and this is the direction of unit vector normal to the plane containing $\vec{E} \times \vec{H}$, according to right hand system. So this is also the direction of propagation of EM wave.

Instantaneous and Average Power Density

- Instantaneous power density

$$\vec{P} = \frac{E_0^2}{\eta} \cos^2(\omega t - \beta z) \cdot \hat{a}_z \text{ Watt/m}^2$$

(ii) Average power density

$$\bar{P}_{avg} = \int_S P_{avg} d\omega t$$

where,

$$\bar{P}_{avg} = \frac{1}{2} \operatorname{Re} \{ \vec{E} \times \vec{H}^* \} \text{ Watt / m}^2$$

(iii) Average power density in lossless medium

$$\bar{P}_{avg} = \frac{1}{2} \frac{E_x^2}{\eta_0} \hat{a}_z = \frac{1}{2} \eta_0 \cdot H_y^2 \hat{a}_z = \frac{1}{2} E_x H_y \hat{a}_z \text{ Watt/m}^2$$

$$\bar{P}_{avg} = \frac{E_{rms}^2}{\eta} \hat{a}_z = \eta H_{rms}^2 \hat{a}_z = E_{rms} H_{rms} \hat{a}_z \text{ Watt / m}^2$$



Incidence of EM Wave

Normal Incidence

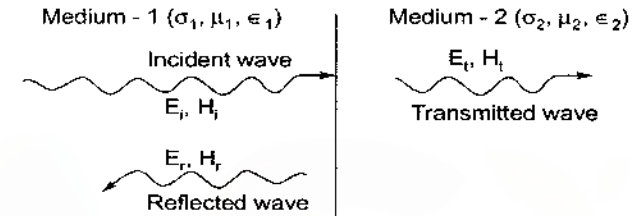

Reflection Coefficient

It is the ratio of electric field of reflected wave to the electric field of incident wave

$$\Gamma = \frac{E_r}{E_i} = \frac{\eta_2 - \eta_1}{\eta_2 + \eta_1}$$

Note:

- Reflection coefficient is a complex quantity and can be written as

$$\Gamma = |\Gamma| e^{j\theta}$$

where $|\Gamma| = \rho$

Transmission Coefficient (T)

It is defined as the ratio of transmitted electric field to the incident electric field

$$T = \frac{E_t}{E_i}$$

$$T = 1 + \Gamma$$

$$T = \frac{2\eta_2}{\eta_2 + \eta_1}$$

Standing Wave Ratio

$$S = \frac{1 + |\Gamma|}{1 - |\Gamma|}$$

or

$$S = \frac{1 + \rho}{1 - \rho}$$

Note:

- $0 \leq |\Gamma| \leq 1$.
- $1 \leq S \leq \infty$.
- Total power reflected = $P_{\text{reflected}} = \Gamma^2$.
- Total power transmitted = $P_{\text{transmitted}} = (1 - \Gamma^2)$.

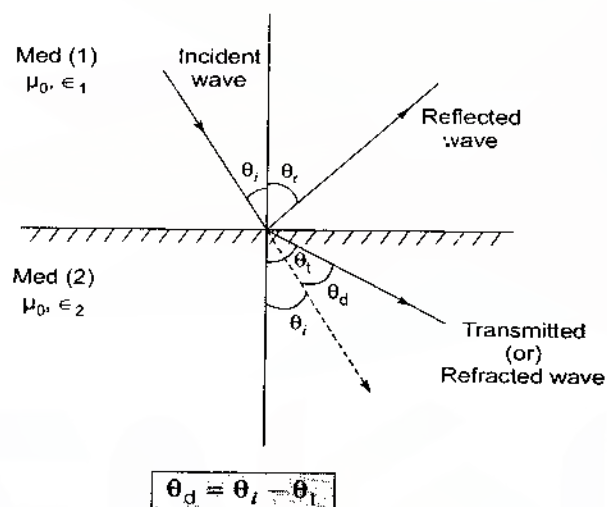
Oblique Incidence**Snell's Law**

$$\eta_1 \sin \theta_i = \eta_2 \sin \theta_t$$

where, $\eta_1 = C\sqrt{\mu_1 \epsilon_1} = C\sqrt{\epsilon_1}$; $\eta_2 = C\sqrt{\mu_2 \epsilon_2} = C\sqrt{\epsilon_2}$

are the refractive indices of the media.

Snell's law for EM wave is

$$\frac{\sin \theta_t}{\sin \theta_i} = \sqrt{\frac{\epsilon_1}{\epsilon_2}}$$

Total Internal Reflection of EM wave

$$\theta_c = \sin^{-1} \sqrt{\frac{\epsilon_2}{\epsilon_1}}$$

where θ_c = critical angle for total internal reflection

Note:

θ_c is the minimum angle of incidence at which total internal reflection just starts.

Condition for total internal reflections

- $n_1 > n_2$
- $\theta_i \geq \theta_c$ or $\theta_i \geq \sin^{-1} \sqrt{\frac{\epsilon_2}{\epsilon_1}}$
- $T = 0 \Rightarrow \Gamma = (T - 1) = -1$

Brewster's Angle (θ_B)

This is the angle of incidence for which complete transmission of EM wave occurs.

$$\tan \theta_B = \sqrt{\frac{\epsilon_2}{\epsilon_1}} = \frac{n_2}{n_1}$$

Note:

When a circularly or elliptically polarized wave is incident at Brewster's angle then the reflected and transmitted wave is linearly polarized. Therefore this angle is also known as polarization angle.

Polarization

This is the orientation electric vector at a fixed position in space with respect to time.

Linear Polarization

Condition: ($\phi = 0^\circ$ or 180°)

$$E_x = E_{x0} \cos \omega t \text{ and } E_y = E_{y0} \cos(\omega t + \phi)$$

1. Parallel polarization

$$E_x = E_{x0} \cos \omega t \text{ and } E_y = 0$$

2. Perpendicular polarization

$$E_x = 0 \text{ and } E_y = E_{y0} \cos \omega t$$

Circular Polarization

Condition: ($\phi = \pm 90^\circ$) and ($E_{x_0} = E_{y_0} = E_0$)

$$E_x = E_{x_0} \cos \omega t \quad \text{and} \quad E_y = E_{y_0} \cos(\omega t + \phi) = \pm E_0 \sin \omega t$$

Note:

- If $\phi = +90^\circ$ the rotation is in clockwise direction than the wave is said to be left hand circularly polarized.
- If $\phi = -90^\circ$ the rotation is in anti-clockwise direction than the wave is said to be right hand circularly polarized.

Elliptical Polarization

Condition: ($\phi = \pm 90^\circ$) and ($E_{x_0} \neq E_{y_0}$)

$$E_x = E_{x_0} \cos \omega t \quad \text{and} \quad E_y = E_{y_0} \cos(\omega t + \phi) = \pm E_{y_0} \sin \omega t$$

Note:

- If $\phi = +90^\circ$ the rotation is in clockwise direction than the wave is said to be left hand elliptically polarized.
- If $\phi = -90^\circ$ the rotation is in anti-clockwise direction than the wave is said to be right hand elliptically polarized.



Transmission Lines

Introduction

These are the structures used for transmitting EM power from source or generator to the load.

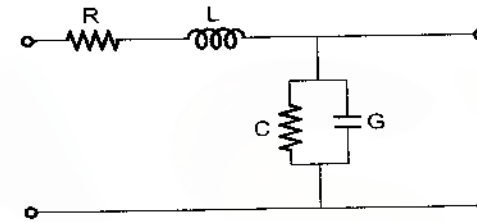

(Electrical equivalent circuit of transmission line in distributed from l length of line)

Voltage and Current in Transmission Line

$$V = \frac{V^+ e^{-\gamma z}}{\text{incident wave}} + \frac{V^- e^{\gamma z}}{\text{Reflected wave}}$$

standing wave

$$I = \frac{1}{Z_0} [V^+ e^{-\gamma z} - V^- e^{\gamma z}]$$

where, V_0^+ and V_0^- are wave amplitudes
and Z_0 = characteristic impedance

Characteristic Impedance (Z_0)

Characteristic impedance (Z_0) of the line is the ratio of the positively traveling voltage wave to the current wave at any point on the line

$$Z_0 = \frac{V^+}{I^+} = \sqrt{\frac{R + j\omega L}{G + j\omega C}} \quad \Omega$$

Propagation Constant

$$\gamma = \alpha + j\beta = \sqrt{(R + j\omega L)(G + j\omega C)} \quad \text{m}^{-1}$$

where, γ = propagation constant
 α = Attenuation constant
 β = phase constant

Lossless Transmission Line

A transmission line is said to be lossless if the conductors of the line are perfect and the dielectric medium separating them is lossless.

$$R = G = 0 \quad ; \quad \gamma = j\omega\sqrt{LC}$$

∴

$$\alpha = 0 \quad \text{and} \quad \beta = \omega\sqrt{LC}$$

$$u = \frac{\omega}{\beta} = \frac{1}{\sqrt{LC}} \quad ; \quad Z_0 = R_0 = \sqrt{\frac{L}{C}}$$

Distortionless Transmission Line

A distortionless line is one in which the attenuation constant α is frequency independent while the phase constant β is linearly dependent on frequency.

$$\frac{R}{L} = \frac{G}{C}$$

$$\alpha = \sqrt{RC} \quad \text{and} \quad \beta = \omega\sqrt{LC}$$

$$u = \frac{\omega}{\beta} = \frac{1}{\sqrt{LC}} = f \cdot \delta \quad ; \quad Z_0 = \sqrt{\frac{R}{G}} = \sqrt{\frac{L}{C}}$$

Input Impedance, Standing Wave Ratio and Power

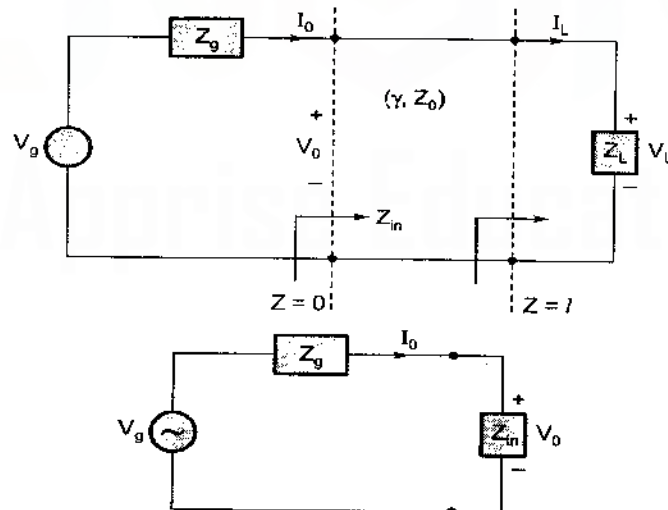

Input Impedance

$$Z_{in} = Z_0 \left[\frac{Z_L + Z_0 \tanh \gamma l}{Z_0 + Z_L \tanh \gamma l} \right] \quad \dots \text{lossy medium}$$

$$Z_{in} = Z_0 \left[\frac{Z_L + jZ_0 \tanh \beta l}{Z_0 + jZ_L \tanh \beta l} \right] \quad \dots \text{lossless medium}$$

Voltage reflection coefficient

The voltage reflection coefficient at any point on the line is the ratio of the reflected voltage wave to that of the incident wave.

$$\Gamma_L = \frac{Z_L - Z_0}{Z_L + Z_0}$$

Current reflection coefficient

The current reflection coefficient at any point on the line is the negative of the voltage reflection coefficient at that point i.e. $-\Gamma_L$.

Standing wave ratio

It is the ratio of maximum voltage of standing wave to the minimum voltage of standing wave.

$$S = \frac{V_{\max}}{V_{\min}} = \frac{1 + |\Gamma_L|}{1 - |\Gamma_L|}$$

Average input power

$$P_{\text{avg}} = \frac{|V^+|^2}{2Z_0} (1 - |\Gamma|^2)$$

Behaviour of Transmission Line due to Variation in Load Impedance (Z_L)

(i) Short circuited line ($Z_L = 0$)

$$Z_{in} = Z_{sc} = jZ_0 \tan \beta l$$

$$\Gamma_L = -1, \quad S = \infty$$

(ii) Open circuited line ($Z_L = \infty$)

$$Z_{in} = Z_{oc} = -jZ_0 \cot \beta l$$

$$\Gamma_L = 1, \quad S = \infty$$

Note:

Characteristic impedance (Z_0) is geometric mean of short circuited and open circuited line input impedance.

$$Z_{sc} Z_{oc} = Z_0^2$$

$$Z_0 = \sqrt{Z_{sc} Z_{oc}}$$

(iii) Matched line ($Z_L = Z_0$)

$$\boxed{Z_{in} = Z_0} \quad ; \quad \boxed{\Gamma_L = 0} \quad ; \quad \boxed{S = 1}$$

Behaviour of transmission line due to variation in length of line 'l'

(i) Infinitely long line ($l = \infty$)

$$\boxed{Z_{in} = Z_0}$$

(ii) For length ($l = \lambda$)

$$\boxed{Z_{in} = Z_L}$$

(iii) For length $l = \lambda/2$ (half wave line)

$$\boxed{Z_{in} = Z_L}$$

(iv) For length $l = \lambda/4$ (quarter wave line)

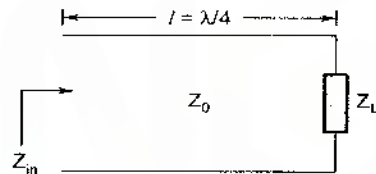

$$\boxed{Z_{in} = \frac{Z_0^2}{Z_L}} \quad \text{or} \quad \boxed{Z_0 = \sqrt{Z_{in} \cdot Z_L}}$$

(v) For length $l = \lambda/8$

$$\boxed{Z_{in} = Z_0 \left[\frac{Z_L + jZ_0}{Z_0 + jZ_L} \right]} \quad ; \quad \boxed{|Z_{in}| = Z_0}$$

Remember:

The magnitude of Z_{in} for $\lambda/8$ line and $l = \infty$ length line are always equal but phase is different hence Z_{in} for $l = \lambda/8$ and $l = \infty$ are not equal.



A Handbook on Electrical Engineering

12

Microprocessors

CONTENTS

1. Introduction	632
2. Architecture of 8085	634
3. Instruction Set and Data Formats	641
4. Interrupts	660
5. Interfacing with Microprocessor	662



Introduction

Microprocessor is a programmable integrating device has computing, storing, retrieving and decision making capability.

Note:

- Computer with microprocessor as its CPU is known as microcomputer.
 - Microcomputer on a single chip is known as microcontroller.
-

History of Microprocessor

Microprocessor	Word length	Memory capacity
Intel4004 (PMOS)	4-bit	640 B
Intel 8008	8-bit	16 kB
Intel 8080 (NMOS)	8-bit	64 kB
Intel 8085 (NMOS)	8-bit	64 kB
Intel 8086 (HMOS)	16-bit	1 MB
Intel 8088	8/16-bit	1 MB
Intel 80186	16-bit	1 MB
Intel 80286	16-bit	16 MB real, 4 GB virtual
Intel 80386	32-bit	4 GB real, 4 GB virtual
Intel 80486	32-bit	4 GB real, 64 TB virtual
Pentium-II	64-bit	64 GB real
Z-80	8-bit	64 kB
Z-800	8-bit	500 kB

Table 1.1 : A brief review of various microprocessors

Computer language

1. Mnemonic

A combination of letters to suggest the operation of an instruction.

2. Program

A set of instruction written in a specific sequence for the computer to accomplish a given task.

3. Machine language

A computer uses binary digits for its operation.

4. Assembly language

In this language programs are written as English like word.

5. Low level language

Machine specific languages are known as low level language e.g. Machine language, Assembly language.

6. High level language

High level language are general purpose language which are machine independent language.

Assembler

It is a computer program that translates an assembly language program from mnemonics to the binary machine code of a computer.

Remember:

- High level language programming requires a translator like a compiler or an interpreter to translate the program written in a high level language to binary form.
 - Interpreter reads one line at a time, converts it into object code, executes and then reads the next line but compiler reads whole program at a time and convert it into the object code and then execute.
-

Bit: A binary digit, 0 or 1

Nibble: A group of four bits

Byte: A group of eight bits

Word: A group of byte the computer recognizes and processor at a time.



2

Architecture of 8085

There are two types of architecture depending upon storage of program and data in memory

- (i) Von Neumann architecture of computers : Intel 8085 Intel 8086
- (ii) Harvard architecture of computer : TMS 32010, Intel 8051, Intel's Pentium etc.

Pin outs of 8085

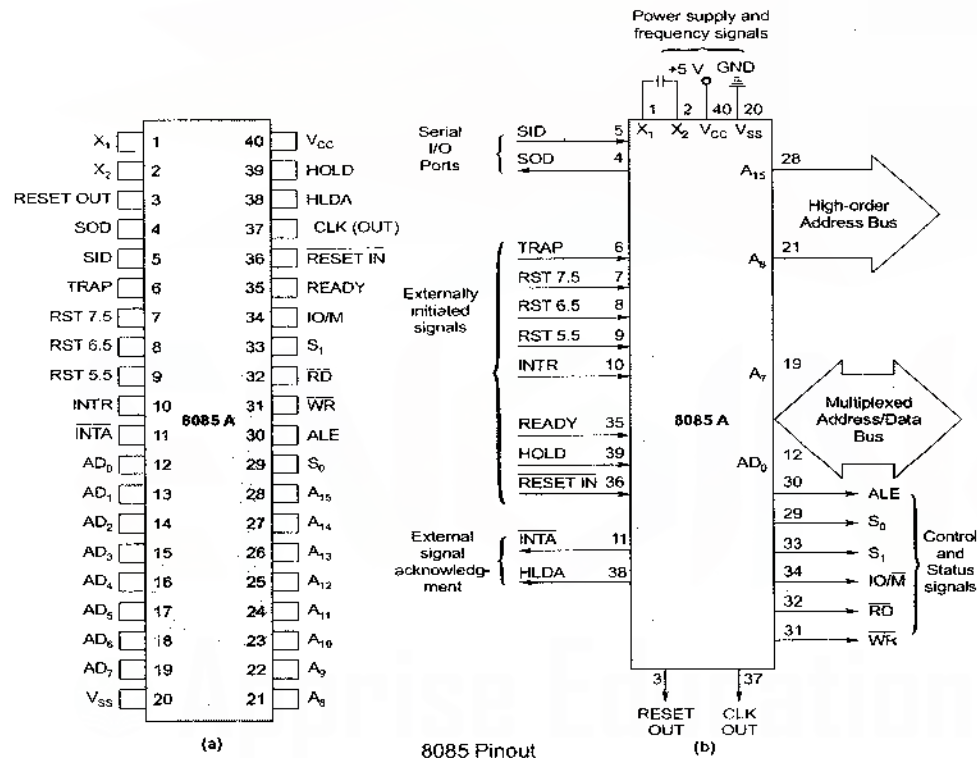

Key features of 8085

- (i) It is a 8-bit processor.
- (ii) It has 8 data bus lines, which is the bit capacity of the microprocessor.
- (iii) It has total 16 address lines with addressing capacity of 64 kB.
- (iv) The crystal frequency of processor is 6 MHz and the clock frequency is 3.07 MHz (= 3 MHz), which is approximately half the crystal frequency.

- (v) Low order address bus ($AD_0 - AD_7$) is multiplexed with data bus in order to reduce the number of pins.
- (vi) To de-multiplex address from data, ALE (Address Latch Enable) signal is used.
ALE = 1, Address transfer to bus
ALE = 0, data transfer to bus.
- (vii) Disadvantage of multiplexing is that speed will be reduced.
- (viii) There are 5 hardware interrupts available for 8085.
- (ix) 8085 has 74 basic instructions with 246 Opcodes.

Sr. No.	Signals	Pins
1.	Power supply signals	V_{CC}, V_{SS}
2.	Clock signals	$X_1, X_2, CLK OUT$
3.	Reset signals	RESET IN, RESET OUT
4.	Interrupt signals	TRAP, Restart interrupts (RST 7.5, RST 6.5 and RST 5.5), INTR, INTA
5.	Address bus and data bus	Address bus ($A_8 - A_{15}$) Multiplexed address/data bus ($AD_0 - AD_7$)
6.	Status signals and control signals	Address latch enable (ALE), Input output/memory (IO/M), Status signals (S_1 and S_0), Read (\overline{RD}), Write (\overline{WR}), READY
7.	Serial input/output signals	HOLD, HLDA
8.	DMA request signals	SID, (Serial input data), SOD (Serial output data)

Address bus ($A_8 - A_{16}$)

Higher order 8 bit of 16 bit address. The address bus is always unidirectional.

Multiplexed address/data bus ($AD_0 - AD_7$)

It is a bidirectional bus. The data bus is multiplexed with lower order address bus.

Control and status signal

- (i) \overline{RD} (Read) : When the signal is low on this pin, the microprocessor performs memory reading or I/O reading operation.
- (ii) \overline{WR} (Write) : When the signal is low on this pin, the microprocessor performs memory writing or I/O writing operation.
- (iii) IO/\overline{M} : This status signal is used to give information of operation to be performed with memory or I/O device.

IO/M	RD	WR	Description
0	0	1	Memory read (MEMR)
0	1	0	Memory write (MEMW)
1	0	1	IO Read (IO \bar{R})
1	1	0	IO Write (IO \bar{W})

S_1 and S_0 : These two status signal used to indicate the status of the operation.

S_1	S_0	Microprocessor operation
0	0	Halt (No operation)
0	1	Write operation
1	0	Read operation
1	1	Opcode fetch (reading instruction)

Power supply and frequency signals

V_{CC} : Power supply pin of +5V

X_1 and X_2 : A crystal is connected across these pins. The frequency is internally divided by two.

CLK (out): This pin, there will be synchronization between the different peripherals and microprocessor.

Serial I/O Port

(i) SID (Serial Input Data): This pin is used for receiving the data into microprocessor serially.

(ii) SOD (Serial output data): This pin is used for sending the data from the microprocessor serially.

Externally initiated signals

1. Hardware interrupts

TRAP, RST-7.5, RST-6.5, RST-5.5, INTR are called Hardware interrupts. It is also used to accepts external interrupts to provide acknowledgment (Ack) to the external device.

Remember:

In priority order, interrupts are as TRAP > RST-7.5 > RST-6.5 > RST-5.5 > INTR.

2. READY

It is used to interface with the slow peripheral devices (Memory or I/O devices) to the microprocessor.

3. Reset

(a) RESET IN: It is an active low signal, when this signal gets activated and microprocessor is reset.

(b) RESET OUT: This signal is used to reset the other peripheral devices.

4. HOLD and HLDA

(a) HOLD: A peripheral like DMA controller sends the HOLD request to the microprocessor through this pin to leave the data bus which where also used by microprocessor.

(b) HLDA: HOLD acknowledge

Internal Architecture of 8085 Microprocessor

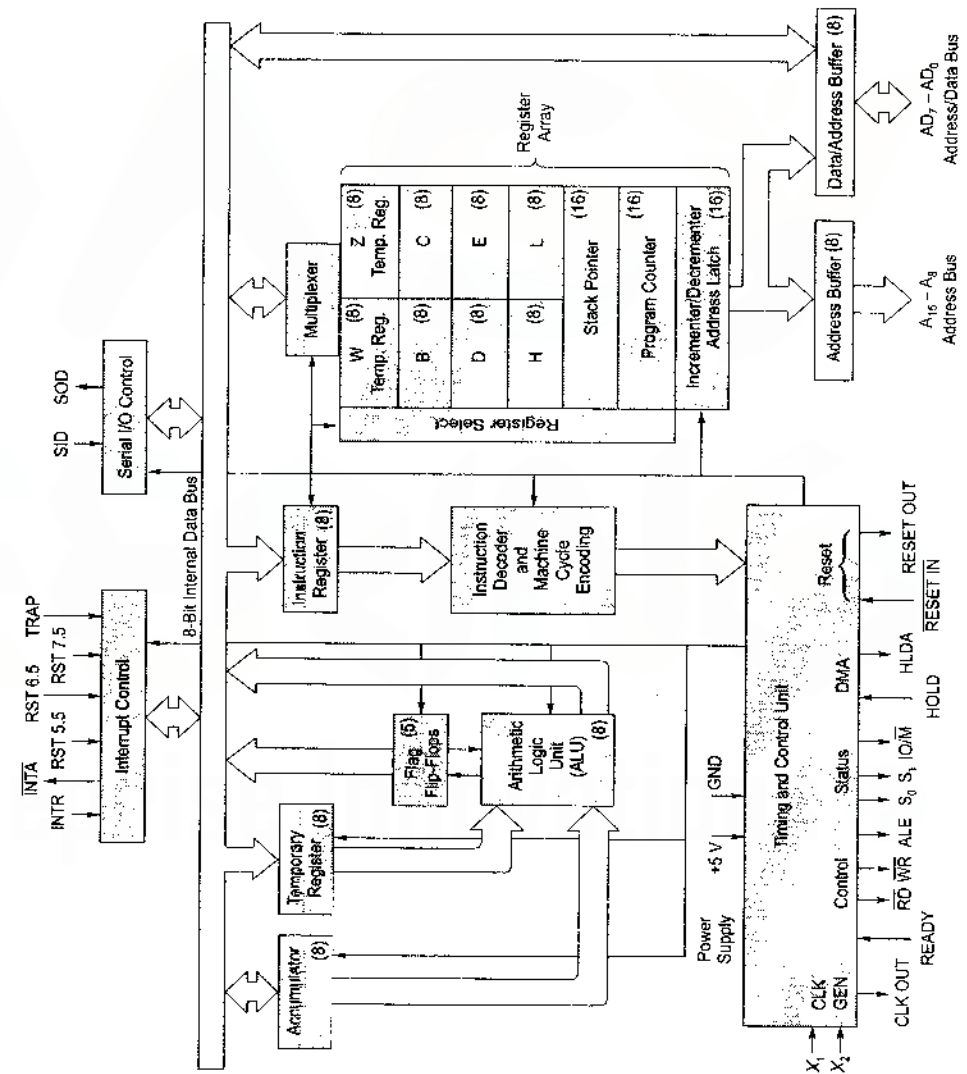

The architecture is divided into following blocks:

1. Arithmetic and Logical Unit (ALU)

The ALU performs arithmetical and logical operations. It includes

- Accumulator : It is a 8 bit programmable register. All the arithmetic and logical operations performed with contents of accumulator and the results are store in accumulator only.
- Temporary Register : It is an 8 bit non-programmable register used to hold data during an arithmetics and logic operation.
- Arithmetic and logic circuits : This unit performs the actual numerical and logical operation.
- Flags : The flags generally reflect the status of arithmetic or logical operation.

D ₇	D ₆	D ₅	D ₄	D ₃	D ₂	D ₁	D ₀
S	Z	X	AC	X	P	X	CY

- **Carry flag (CY):** If an arithmetic operation results in a carry, the CY flag is **set** otherwise it is **reset**.
- **Parity flag (P):**
 - ⇒ If the result has an even number of 1's, the flag is **set**.
 - ⇒ If the result has an odd number of 1's the flag is **reset**.
- **Auxiliary Carry (AC):** In an arithmetic operation.
 - ⇒ If carry is generated by bit D₃ and passed to D₄, flag is **set**.
 - ⇒ Otherwise it is **reset**.
- **Zero Flag (Z):**
 - ⇒ Zero flag is **set** to 1, when the result is zero.
 - ⇒ Otherwise it is **reset**.
- **Sign Flag (S):**
 - ⇒ Sign flag is **set** if bit D₇ of the result is 1.
 - ⇒ Otherwise it is **reset**.

Remember:

- Among the five flags, the AC flags is used internally for BCD arithmetic; the instruction set does not include any conditional Jump instruction based on the AC flag.
- 'x' in the flag register indicate the unused flip-flops.
- The values of D₁, D₃ and D₅ bits should be taken as '0' in programs while using PSW instruction.

2. Register array

The architecture of 8085 consist of following registers.

(a) Temporary registers :

- Temporary data register : It is also called as operand register (8-bit). It provides operands to the ALU.
- Temporary registers (W and Z) : This registers are not available to the user.

Remember:

W and Z registers are used by 8085 for swap instruction.

(b) General purpose registers :

The 8085 microprocessor consists 6 general purpose registers i.e. B, C, D, E, H, and L of 8 bits each. These registers are available to the user.

Remember:

- The general purpose registers put together is called **scratch and memory**.
- The valid register pairs available are BC, DE and HL to store 16-bit of data.
- The HL register pair functions as default data pointer. If used as memory pointer it holds the address of a 16 bit address at a memory location.
- Accumulator can also be used along with status register to form a 16 bit programmable register called **program status word (PSW)**.

(c) Special purpose registers

There are two 16-bit special purpose register i.e. program counter (PC) and stack pointer (SP).

- Program counter : It is a 16 bit register used to hold memory addresses.
- Stack pointer : It is a 16 bit register used as a memory pointer.

Remember:

- When the microprocessor is reset, the PC sets to zero.
- Stack grows from bottom to top following last in first out (LIFO) structure and the SP contents keep decreasing as stack grows.

3. Increment and Decrement Latch

It is used for increment or decrement of 16 bit address, always increment and decrement by '1'.

4. Timing and control unit

It controls all internal and external circuits in the microprocessor system.

Remember:

The microprocessor uses a quartz crystal (LC or RC circuits) to determine the clock frequency, so that other timing and control signals are developed.

5. Instruction Register and Decoder

It is the part of ALU and not Assessible to the user.

- (a) **Instruction register** :– The instruction register holds the opcode of the instruction that is decoded and executed.
- (b) **Instruction decoder** :– The output of instruction register connected to the decoder. The decoder decodes the instruction and establishes the sequence of events to follow.

6. Interrupt Control Unit

The interrupt control units job is to service the interrupt and after completing the interrupt service routine return back the control to the main program where it was interrupted.



Instruction Set and Data Formats

3

Timing Diagram

Instruction cycle

The CPU fetches one instruction from the memory at a time and executes it. One instruction cycle can consists of 1-6 machine cycle.

Note:

An instruction cycle consists of a fetch cycle and execute cycle.

Machine Cycle

The time required by the microprocessor to complete the operation of accessing memory or I/O device is called as a machine cycle. One machine cycle can consists of 3-6 T-states.

Note:

- An instruction cycle consists of several machine cycles.
- Different types of machine cycles are opcode fetch (4T-6T), memory read (3T), memory write (3T), I/O read(3T), I/O write (3T), INTR Acknowledge and BUS Idle(3T).

T-State

Microprocessor perform an operation in a specific time period i.e. specific clock cycles. Each clock cycle is called as T-state.

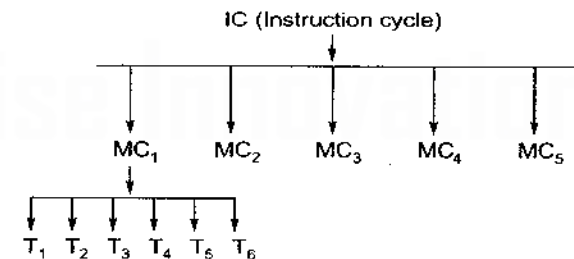

Classification of Instructions Set of 8085 Microprocessor

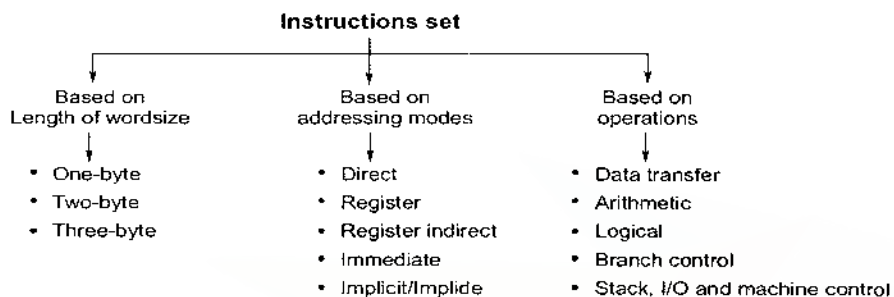

An instruction is a binary Pattern designed inside a microprocessor to perform a specific function.

Based on Length of Word Size

- One-Byte Instructions:** The one-byte instructions specify the operation to be performed and who is going to perform it. These instructions, required one or single memory location.
- Two-Byte Instructions:** The Two-byte instruction uses first byte to specify the operation i.e. opcode and second byte to specify the operand. These instructions required two successive memory locations in the memory.
- Three-Byte instructions:** First byte stores opcode, second byte stores lower order 8-bit of 16-bit operand or address and third byte stores higher order 8-bit of 16-bit operand or address.

Based on Addressing Modes

- Register addressing mode:** In register addressing mode the source and the destination are general purpose registers.
- Immediate addressing mode:** In immediate addressing mode the data (8/16 bit) is specified in the instruction itself.
- Direct addressing mode:** In direct addressing mode 16 bit address of the operand is given within the instruction itself.
- Indirect addressing mode:** In indirect addressing mode the instructions reference the memory through a register pair, i.e. the memory address where the operand is located is specified by the contents of a register pair.
- Implicit addressing mode:** The implicit mode of addressing does not require any operand. The data is specified within the opcode itself.

Based on Operations

Abbreviations used in the description of the instruction set:

R = Register	Rs = Register source
Rd = Register destination	M = Memory
Rp = Register pair	() = Contents of
XX = Random information	S = Sign flag
Z = Zero flag	AC = Auxiliary carry flag
P = Parity flag	CY = Carry flag

Data Transfer Instruction

MOV : Move – Copy from Source to Destination

Opcode	Operand	Bytes	M-Cycles	T-States
MOV	Rd/M, Rs/M	1	1/2	4T/7T

Description:

This instruction copies the contents of the source register into the destination register; the contents of the source register are not altered.

MVI : Move Immediate 8-Bit

Opcode	Operand	Bytes	M-Cycles	T-States
MVI	R/M, 8-bit data	2	2/3	7T/10T

Description

The 8-bit data are stored in the destination register or memory.

LXI : Load Register Pair Immediate

Opcode	Operand	Bytes	M-Cycles	T-States
LXI	Rp, 16-bit data	3	3	10T

Description:

The instruction loads 16-bit data in the register pair designated in the operand.

Comments:

.....
 The reverse order in entering the code of 16-bit data. This is the only instruction that can directly load a 16-bit address in the stack pointer register.

LDA : Load Accumulator Direct

Opcode	Operand	Bytes	M-Cycles	T-States
LDA	16-bit address	3	4	13T

Description:

The contents of a memory location, specified by a 16-bit address in the operand, are copied to the accumulator. The contents of the source are not altered.

STA : Store Accumulator Direct

Opcode	Operand	Bytes	M-Cycles	T-States
STA	16-bit address	3	4	13T

Description:

The contents of the accumulator are copied to a memory location specified by the operand.

LHLD : Load H and L Registers Direct

Opcode	Operand	Bytes	M-Cycles	T-States
LHLD	16-bit address	3	5	16T

Description:

The instruction copies the contents of the memory location pointed out by the 16-bit address in register L and copies the contents of the next memory location in register H.

SHLD : Store H and L Registers Direct

Opcode	Operand	Bytes	M-Cycles	T-States
SHLD	16-bit address	3	5	16T

Description:

The contents of register L are stored in the memory location specified by the 16-bit address in the operand, and the contents of H register are stored in the next memory location by incrementing the operand. The contents of registers HL are not altered.

LDAX : Load Accumulator Indirect

Opcode	Operand	Bytes	M-Cycles	T-States
LDAX	B/D Rp	1	2	7T

Description:

The contents of the designated register pair point to a memory location. This instruction copies the contents of that memory location into the accumulator.

Flags:

No flags are affected.

STAX : Store Accumulator Indirect

Opcode	Operand	Bytes	M-Cycles	T-States
STAX	B/D Rp	1	2	7T

Description:

The contents of the accumulator are copied into the memory location specified by the contents of the operand (register pair).

Flags:

No flags are affected.

XCHG : Exchange H and L with D and E

Opcode	Operand	Bytes	M-Cycles	T-States
XCHG	None	1	1	4T

Description:

The contents of register H are exchanged with the contents of register D, and the contents of register L are exchanged with the contents of register E.

Arithmetic Instructions**ADD : Add Register to Accumulator**

Opcode	Operand	Bytes	M-Cycles	T-States
ADD	R/M	1	1/2	4T/7T

Description:

The contents of the operand (register or memory) are added to the contents of the accumulator and the result is stored in the accumulator.

ADC : Add Register to Accumulator with Carry

Opcode	Operand	Bytes	M-Cycles	T-States
ADC	R/M	1	1/2	4T/7T

Description:

The contents of the operand (register or memory) and the Carry flag are added to the contents of the accumulator and the result is placed in the accumulator.

ACI : Add Immediate to Accumulator with Carry

Opcode	Operand	Bytes	M-Cycles	T-States
ACI	8-bit data	2	2	7

Description:

The 8-bit data (operand) and the Carry flag are added to the contents of the accumulator, and the result is stored in the accumulator.

ADI : Add Immediate to Accumulator

Opcode	Operand	Bytes	M-Cycles	T-States
ADI	8-bit data	2	2	7T

Description:

The 8-bit data (operand) are added to the contents of the accumulator, and the result is placed in the accumulator.

Flags:

All flags are modified to reflect the result of the addition.

SBB : Subtract Source and Borrow from Accumulator

Opcode	Operand	Bytes	M-Cycles	T-States
SBB	R/M	1	1/2	4T/7T

Description:

The contents of the operand (register or memory) and the Borrow flag are subtracted from the contents of the accumulator and the results are placed in the accumulator.

SUB : Subtract Register or Memory from Accumulator

Opcode	Operand	Bytes	M-Cycles	T-States
SUB	R/M	1	1/2	4T/7T

Description:

The contents of the register or the memory location specified by the operand are subtracted from the contents of the accumulator, and the results are placed in the accumulator.

SBI : Subtract Immediate with Borrow

Opcode	Operand	Bytes	M-Cycles	T-States
SBI	8-bit data	2	2	7T

Description:

The 8-bit data (operand) and the borrow are subtracted from the contents of the accumulator, and the results are placed in the accumulator.

SUI : Subtract Immediate from Accumulator

Opcode	Operand	Bytes	M-Cycles	T-States
SUI	8-bit data	2	2	7T

Description:

The 8-bit data (the operand) are subtracted from the contents of the accumulator, and the results are placed in the accumulator.

INR : Increment Contents of Register/Memory by 1

Opcode	Operand	Bytes	M-Cycles	T-States
INR	R/M	1	1/3	4T/10T

Description:

The contents of the designated register/memory are incremented by 1 and the results are stored in the same place.

DCR : Decrement Source by 1

Opcode	Operand	Bytes	M-Cycles	T-States
DCR	R/M	1	1/3	4T/10T

Description:

The contents of the designated register/memory is decremented by 1 and the results are stored in the same place.

Note:

In INR and DCR operation except carry all flags are affected.

INX : Increment Register Pair by 1

Opcode	Operand	Bytes	M-Cycles	T-States
INX	Rp	1	1	6T

Description:

The contents of the specified register pair are incremented by 1. The instruction views the contents of the two registers as a 16-bit number.

DCX : Decrement Register Pair by 1

Opcode	Operand	Bytes	M-Cycles	T-States
DCX	Rp	1	1	6T

Description:

The contents of the specified register pair are decremented by 1. This instruction views the contents of the two registers as a 16-bit number.

Flags:

No flags are affected.

DAA : Decimal Adjust Accumulator

Opcode	Operand	Bytes	M-Cycles	T-States
DAA	None	1	1	4T

Description:

1. If the value of the low-order four bits ($D_3 - D_0$) in the accumulator is greater than 9 or if AC flag is set, the instruction adds 6(06) to the low-order four bits.
2. If the value of the high-order four bits ($D_7 - D_4$) in the accumulator is greater than 9 or if the Carry flag is set, the instruction adds 6(60) to the high-order four bits.

Flags:

S, Z, AC, P, CY flags are altered to reflect the results of the operation.

DAD : Add Register Pair to H and L Registers

Opcode	Operand	Bytes	M-Cycles	T-States
DAD	Rp	1	3	10T

Description:

The 16-bit contents of the specified register pair are added to the contents of the HL register and the sum is saved in the HL register. The contents of the source register pair are not altered.

Flags:

If the result is larger than 16-bits the CY flag is set. No other flags are affected.

Note:

After the execution of the instruction, the contents of the stack pointer register are not altered.

Logical Instructions**ANA : Logical AND with Accumulator**

Opcode	Operand	Bytes	M-Cycles	T-States
ANA	R/M	1	1/2	4T/7T

Description:

The contents of the accumulator are logically ANDed with the contents of the operand (register or memory), and the result is placed in the accumulator.

ANI : AND Immediate with Accumulator

Opcode	Operand	Bytes	M-Cycles	T-States
ANI	8-bit data	2	2	7T

Description:

The contents of the accumulator are logically ANDed with the 8-bit data (operand) and the results are placed in the accumulator.

ORA : Logically OR with Accumulator

Opcode	Operand	Bytes	M-Cycles	T-States
ORA	R/M	1	1/2	4T/7T

Description:

The contents of the accumulator are logically ORed with the contents of the operand (register or memory).

ORI : Logically OR Immediate

Opcode	Operand	Bytes	M-Cycles	T-States
ORI	8-bit data	2	2	7T

Description:

The contents of the accumulator are logically ORed with the 8-bit data in the operand and the results are placed in the accumulator.

XRA : Exclusive OR with Accumulator

Opcode	Operand	Bytes	M-Cycles	T-States
XRA	R/M	1	1/2	4T/7T

Description:

The contents of the operand (register or memory) are Exclusive ORed with the contents of the accumulator.

XRI : Exclusive OR Immediate with Accumulator

Opcode	Operand	Bytes	M-Cycles	T-States
XRI	8-bit data	2	2	7T

Description:

The 8-bit data (operand) are Exclusive ORed with the contents of the accumulator, and the results are placed in the accumulator.

Flags:

Z, S, P are altered to reflect the results of the operation. CY and AC are reset.

CMA : Complement Accumulator

Opcode	Operand	Bytes	M-Cycles	T-States
CMA	None	1	1	4T

Description:

The contents of the accumulator are complemented.

Flags:

No flags are affected.

CMP : Compare with Accumulator

Opcode	Operand	Bytes	M-Cycles	T-States
CMP	R/M	1	1/2	4T/7T

Description:

- The contents of the operand (register or memory) are compared with the contents of the accumulator. Both contents are preserved and the comparison is shown by setting the flags as follows:
 - ⇒ If $(A) < (R/M)$: Carry flag is set and Zero flag is reset.
 - ⇒ If $(A) = (R/M)$: Zero flag is set and Carry flag is reset.
 - ⇒ If $(A) > (R/M)$: Carry and Zero flags are reset.
- The comparison of two bytes is performed by subtracting the contents of the operand from the contents of the accumulator; however, neither contents are modified.

Flags:

- S, P, AC are also modified in addition to Z and CY to reflect the results of the operation.

CPI : Compare Immediate with Accumulator

Opcode	Operand	Bytes	M-Cycles	T-States
CPI	8-bit	2	2	7T

Description:

- The second byte (8-bit data) is compared with the contents of the accumulator.
 - ⇒ If $(A) < \text{Data}$: Carry flag is set and Zero flag is reset.
 - ⇒ If $(A) = \text{Data}$: Zero flag is set and Carry flag is reset.
 - ⇒ If $(A) > \text{Data}$: Carry and Zero flags are reset.
- The comparison of two bytes is performed by subtracting the data byte from the contents of the accumulator; however, neither contents are modified.

Flags:

S, P, AC are also modified in addition to Z and CY to reflect the result of the operation.

CMC : Complement Carry

Opcode	Operand	Bytes	M-Cycles	T-States
CMC	None	1	1	4T

Description:

The Carry flag is complemented.

Flags:

The Carry flag is modified, no other flags are affected.

STC : Set Carry

Opcode	Operand	Bytes	M-Cycles	T-States
STC	None	1	1	4T

Description:

The Carry flag is set.

Flags:

No other flags are affected.

RLC : Rotate Accumulator Left

Opcode	Operand	Bytes	M-Cycles	T-States
RLC	None	1	1	4T

Description:

Each binary bit of the accumulator is rotated left by one position. Bit D_7 is placed in the position of D_0 as well as in the Carry flag.

Flags:

CY is modified according to bit D_7 . S, Z, P, AC are not affected.

RAL : Rotate Accumulator Left through Carry

Opcode	Operand	Bytes	M-Cycles	T-States
RAL	None	1	1	4T

Description:

Each binary bit of the accumulator is rotated left by one position through the Carry flag. Bit D_7 is placed in the bit in the Carry flag and the Carry flag is placed in the least significant position D_0 .

Flags:

CY is modified according to bit D_7 . S, Z, AC, P are not affected.

RRC : Rotate Accumulator Right

Opcode	Operand	Bytes	M-Cycles	T-States
RRC	None	1	1	4T

Description:

Each binary bit of the accumulator is rotated right by one position. Bit D_0 is placed in the position of D_7 as well as in the Carry flag.

Flags:

CY is modified according to bit D_0 . S, Z, P, AC are not affected.

RAR : Rotate Accumulator Right through Carry

Opcode	Operand	Bytes	M-Cycles	T-States
RAR	None	1	1	4T

Description:

Each binary bit of the accumulator is rotated right by one position through the Carry flag. Bit D_0 is placed in the Carry flag and the bit in the Carry flag is placed in the most significant position D_7 .

Flags:

CY is modified according to bit D_0 . S, Z, P, AC are not affected.

Branch Control Instructions**JMP : Jump Unconditionally**

Opcode	Operand	Bytes	M-Cycles	T-States
JMP	16-bit	3	3	10T

Description:

This instruction is equivalent to a 1-byte unconditional Jump instruction. The program sequence is transferred to the memory location specified by the 16-bit address.

PCHL : Load Program Counter with HL Contents

Opcode	Operand	Bytes	M-Cycles	T-States
PCHL	None	1	1	6T

Description:

The contents of registers H and L are copied into the program counter.

Flags:

No flags are affected.

CALL : Unconditional Subroutine Call

Opcode	Operand	Bytes	M-Cycles	T-States
CALL	16-bit address	3	5	18T

Description:

The program sequence is transferred to the address specified by the operand. Before the transfer, the address of the next instruction to CALL (the contents of the program counter) is pushed on the stack.

Flags:

No flags are affected.

RET : Return from Subroutine Unconditionally

Opcode	Operand	Bytes	M-Cycles	T-States
RET	None	1	3	10T

Description:

The program sequence is transferred from the subroutine to the calling program. The instruction is equivalent to POP program counter.

Flags:

No flags are affected.

XTHL : Exchange H and L with Top of Stack

Opcode	Operand	Bytes	M-Cycles	T-States
XTHL	None	1	5	16T

Description:

The contents of the L register are exchanged with the stack location pointed out by the contents of the stack pointer register. The contents of the H register are exchanged with the next stack location ($SP + 1$).

Flags:

No flags are affected.

Stack, I/O and Machine Control Instructions**NOP : No Operation**

Opcode	Operand	Bytes	M-Cycles	T-States
NOP	None	1	1	4T

Description:

No operation is performed.

Comments:

The instruction is used to fill in time delays or to delete and insert instructions while troubleshooting.

NOP : Halt and Enter Wait State

Opcode	Operand	Bytes	M-Cycles	T-States
HLT	None	1	2 or more	4T or more

Description:

The microprocessor finishes executing the current instruction and halts any further execution.

Note:

NOP and HLT bot are same as no operation. However, when NOP is executed the PC is increased by 1 time where as for HLT PC remains the same.

PUSH : Push Register Pair onto Stack

Opcode	Operand	Bytes	M-Cycles	T-States
PUSH	Rp	1	3	12T

Description:

The contents of the register pair designated in the operand are copied into the stack in the following sequence. The stack pointer register is decremented and the contents of the high-order register (B, D, H, A) are copied into that location. The stack pointer register is decremented again and the contents of the low-order register (C, E, L, flags) are copied to that location.

Flags:

No flags are modified.

POP : Pop off Stack to Register Pair

Opcode	Operand	Bytes	M-Cycles	T-States
POP	Rp	1	3	10T

Description:

The contents of the memory location pointed out by the stack pointer register are copied to the low-order register (such as C, E, L and flags) of the operand. The stack pointer is incremented by 1 and the contents of that memory location are copied to the high-order register (B, D, H, A) of the operand. The stack pointer register is again incremented by 1.

Flags:

No flags are modified.

Note:

The contents of the source, stack locations, are not altered after the POP instruction.

RSTn : Restart

Opcode	Operand	Bytes	M-Cycles	T-States
RSTn	None	1	3	12T

Description:

This instruction is equivalent to 1-byte CALL instruction.

Flags:

No flags are affected.

SPHL : Copy H and L Registers to the Stack Pointer

Opcode	Operand	Bytes	M-Cycles	T-States
SPHL	None	1	1	6T

Description:

The instruction loads the contents of the H and L registers into the stack pointer register.

Flags:

No flags are affected.

Note:

- This instruction performs the same function as MOV A, M except this instruction uses the contents of BC or DE as memory pointers.
- This instruction is used in conjunction with CALL or conditional call instructions.

IN : Input Data to Accumulator from a Port with 8-bit Address

Opcode	Operand	Bytes	M-Cycles	T-States
IN	8-bit port address	2	3	10T

Description:

The contents of the input port designated in the operand are read and loaded into the accumulator.

Flags:

No flags are affected.

IUT : Output Data from Accumulator to a Port with 8-Bit Address

Opcode	Operand	Bytes	M-Cycles	T-States
OUT	8-bit port address	2	3	10T

Description:

The contents of the accumulator are copied into the output port specified by the operand.

Flags:

No flags are affected.

EI : Enable Interrupts

Opcode	Operand	Bytes	M-Cycles	T-States
EI	None	1	1	4T

Description:

The Interrupt Enable flip-flop is set and all interrupts are enabled.

Flags:

No flags are affected.

Comments:

After a system reset or the acknowledgment of an interrupt, the Interrupt Enable flip-flop is reset, thus disabling the interrupts. This instruction is necessary to enable the interrupts (except TRAP).

DI : Disable Interrupts

Opcode	Operand	Bytes	M-Cycles	T-States
DI	None	1	1	4T

Description:

The Interrupt Enable flip-flop is reset and all the interrupts except the TRAP (8085) are disabled.

Flags:

No flags are affected.

Comments:

This instruction is commonly used when the execution of a code sequence cannot be interrupted.

RIM : Read Interrupt Mask

Opcode	Operand	Bytes	M-Cycles	T-States
RIM	None	1	1	4T

Description:

This is a multipurpose instruction used to read the status of interrupts 7.5, 6.5, 5.5 and to read serial data input bit.

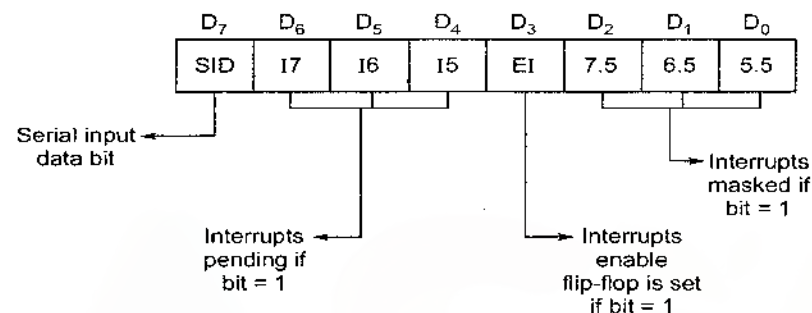
**Flags**

No flags are affected.

SIM : Set Interrupt Mask

Opcode	Operand	Bytes	M-Cycles	T-States
SIM	None	1	1	4T

Description:

This is a multipurpose instruction and used to implement the 8085 interrupts (RST 7.5, 6.5 and 5.5) and serial data output.

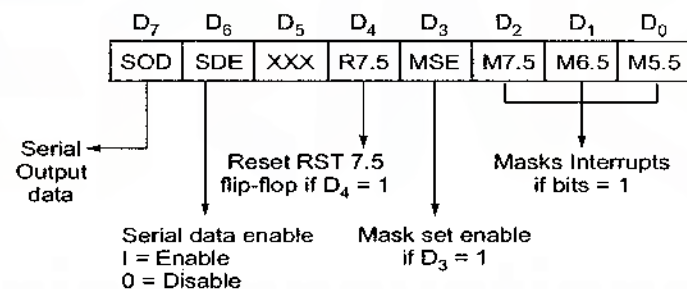

⇒ **SOD (Serial Output Data):** Bit D_7 of the accumulator is latched into the SOD output line and made available to a serial peripheral if bit $D_6 = 1$.

⇒ **SDE (Serial Data Enable):** If this bit = 1, enables the serial output. To implement serial output, this bit needs to be enabled.

⇒ **XXX:** Don't care

⇒ **R7.5 (Reset RST 7.5):** If this bit = 1, RST 7.5 flip-flop is reset. This is an additional control to reset RST 7.5.

- ⇒ **MSE (Mask Set Enable):** If this bit is high, it enables the functions of bits D_2, D_1, D_0 . This is a master control over all the interrupt masking bits. If this bit is low, bits D_2, D_1 and D_0 do not have any effect on the masks.
- ⇒ **M7.5:** $D_2 = 0$, RST 7.5 is enabled.
 $= 1$, RST 7.5 is masked or disabled
- ⇒ **M6.5:** $D_1 = 0$, RST 6.5 is correct.
 $= 1$, RST 6.5 is masked or disabled.
- ⇒ **M6.5:** $D_0 = 0$, RST 5.5 is enabled.
 $= 1$, RST 5.5 is masked or disabled.

Comments:

This instruction does not affect TRAP interrupt.

.....

Counter and Time Delays

- Counters are used primarily to keep track of events.
- Time delays are important in setting up reasonably accurate timing between two events.
- Time delay can be introduced using a loop and total delay = time to execute instructions outside loop + time to execute loop instructions.

$$T_D = T_O + T_{LA}$$

where T_D = Total delay

T_O = Time to execute instructions outside loop.

T_{LA} = Time to execute loop instructions.

- Normally T_O is very small and neglected in most of the cases.
- The accuracy of time delay depends on the accuracy of the system's clock.
- Intel 8254 is a programmable timer chip that can be interfaced with microprocessor and programmed to provide with considerable accuracy.

Remember:

- Data copy instructions do not affect the flags.
- Operand PSW (Program Status Word) represents the contents of the accumulator and the flag register; the accumulator is high-order register and the flags are low-order register.
- Add and subtract are performed in relation to contents of the accumulator, however the increment or decrement operation can be performed in any register.

- Out of all instructions PUSH, CALL, RET, RSTn, INX, DCX, SPHL and PCHL uses 6 T-states for fetch machine cycle.
 - DAD instruction uses bus idle machine cycle.
 - In logical AND, AC is set and carry is reset.
 - In other logical operation AC and carry both are reset and all other flags are changed according to result.
 - NOT operation does not affect any flags.
 - JMP: Instruction is a type of immediate addressing.
 - Conditional jump instructions allow the microprocessor to make decision, based on certain conditions indicated by the flags.
 - INX and DCX does not affect any of the flags.
 - Compare instruction work like subtraction but content of accumulator and register does not change.
 - Stack is a set of memory locations used to store binary information (byte) temporarily during execution of a program.
 - Stack and stack pointer are two different things.
 - Subroutine is also a program written outside main program.
 - CALL and RET instructions are used for execution of subroutine and after execution, return to main program.
-



Interrupts



- When an interrupt is acknowledged the microprocessor perform following tasks:
 1. Microprocessor jumps a vectored location at page 00H where a subroutine (interrupt service routine) is written.
 2. Before jumping microprocessor saves the content of the program counter on the stack.
 3. It automatically resets the interrupt enable flip-flop.
- Interrupt which can be masked or stopped are maskable interrupt otherwise non-maskable interrupt. To mask and demask maskable interrupt of 8085 has to instruction i.e. EI and DI.
- Interrupt those vectored location is fixed are known as vectored interrupt otherwise non-vectored interrupt.

Hardware Interrupts

The 8085 microprocessor has five interrupt signals that can be used to interrupt a program execution.

Interrupt	Triggering	Vectored Address	Maskable/ Non-maskable
TRAP	Edge and level	0024H	Non-maskable
RST 7.5	Edge	002CH	Maskable
RST 6.5	Level	0034H	Maskable
RST 5.5	Level	003CH	Maskable
INTR	Level	Non vectored	Maskable

INTA:

It is the active low interrupt acknowledgment signal which is only used with INTR.

Note:

Trick : Since it is a RST - 4.5,

$$\text{So, } (4.5 \times 8)_{10} = (36)_{10} \xrightarrow{\text{Hexadecimal}} (24)_H \approx (0024)_H$$

Software Interrupt

There are 8 software interrupts which are used either in instructions or alongwith INTR interrupt. They are defined as RSTn where n → 0 to 7.

Software interrupt (RSTn)	Vectored address
RST 0	0000 H
RST 1	0008 H
RST 2	0010 H
RST 3	0018 H
RST 4	0020 H
RST 5	0028 H
RST 6	0030 H
RST 7	0038 H

Remember:

- TRAP is also called RST 4.5 interrupt.
- In interrupts priority order is TRAP > RST 7.5 > RST 6.5 > RST 5.5 > INTR
- Hold has higher priority than TRAP.
- RIM and SIM instructions are not only used for interrupt process but also used for serial I/O process.
- 8259A is a programmable interrupt controller and is used to implement and extend the capability of the 8085 interrupt. It manages 8 interrupt requests.



Interfacing with Microprocessor



Interfacing

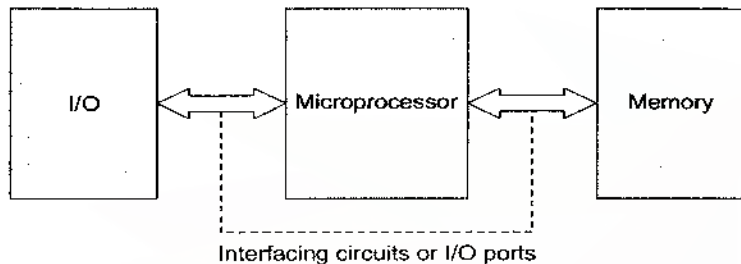

- Designing logic circuits and writing program to make the processor communicated either with memory or I/O is known as interfacing.
- The logic circuits used are known as interfacing circuits or I/O ports.

Characteristics of Memory

Capacity

Memory capacity depends upon the amount of data that can be stored.

- **Memory size** = $2^A \times D$

where $A \rightarrow$ Address lines
 $D \rightarrow$ Data lines

- **Number of chips required**

$$n = \frac{\text{Size of } M_2}{\text{Size of } M_1}$$

where, n = Number of chips required
 M_1 = Available capacity
 M_2 = Memory to be designed

- If initial address and memory size is given then formulae for last address

$$\text{last address} = [\text{Initial address in hexadecimal} + \text{hexadecimal equivalent of memory size} - (1)_H]$$

- If memory range is given then formulae for calculating memory size

$$\text{Memory size} = [(\text{last address})_H - (\text{Initial address})_H + (1)_H] \text{ byte}$$

Remember:

- 8085 microprocessor internally divide the crystal oscillator frequency by 2 so crystal oscillator frequency is always 2 times the microprocessor frequency of operation.
- Data bus reflects the bit of microprocessor.
- Address bus reflects maximum memory that can be interfaced to microprocessor.

Interfacing with I/O Ports

There are two ways by which I/O port can be connected to the microprocessor:

1. Memory mapped I/O scheme
2. I/O mapped I/O scheme

Comparison between Memory Mapped I/O and I/O Mapped I/O Scheme

Characteristic	Memory-mapped I/O	I/O Mapped I/O
• Device Address	16-bit	8-bit
• Control signals for Input/Output	$\overline{\text{MEMR}} / \overline{\text{MEMW}}$	$\overline{\text{IOR}} / \overline{\text{IOW}}$
• Instruction available	Memory-related instructions such as LDA; STA; LDAX; STAX; MOV M, R; ADD M, SUB M; ANA M; etc.	IN and OUT
• Data Transfer	Between any register and I/O	Only between I/O and the accumulator.
• Maximum number of input/output devices possible	The memory map (64 K) is shared between I/O devices and system memory.	The I/O map is independent of the memory map; 256 input devices and 256 output devices can be connected.
• Execution speed	13 T-states (STA, LDA) 7 T-states (MOV M,R)	10 T-states
• Hardware requirements	More hardware is needed to decode 16-bit address.	Less hardware is needed to decode 8-bit address.
• Other features	Arithmetic or logical operations can be directly performed with I/O data.	Not available

Interfacing Devices

Intel 8155 : Programmable Peripheral Interface

The 8155 includes 256 bytes of RD/WR memory i.e. RAM, 3 I/O ports and a 16-bit timer.

Format of 8155 Timer

$$\text{LSB Timer} = \begin{array}{|c|c|c|c|c|c|c|c|} \hline T_7 & T_6 & T_5 & T_4 & T_3 & T_2 & T_1 & T_0 \\ \hline \end{array}$$

$$\text{MSB Timer} = \begin{array}{|c|c|c|c|c|c|c|c|} \hline M_2 & M_1 & T_{13} & T_{12} & T_{11} & T_{10} & T_9 & T_8 \\ \hline \end{array}$$

Where, M_2 M_1 Modes

- | | | | | |
|---|---|--------|---|-----------------------------------|
| 0 | 0 | Mode 0 | ⇒ | Single square wave cycle |
| 0 | 1 | Mode 1 | ⇒ | Square wave |
| 1 | 0 | Mode 2 | ⇒ | Single pulse after terminal count |
| 1 | 1 | Mode 3 | ⇒ | Pulse every terminal count |

Intel 8255 : Programmable Peripheral Interface/Adopter

The 8285 is widely used programmable parallel I/O device. It can be program to transfer data under various conditions from I/O to interrupt I/O.

Operating modes of 8255

1. Mode 0 ⇒ Simple input/output
2. Mode 1 ⇒ Strob input/output
3. Mode 2 ⇒ Bidirectional port

Intel 8251 : Programmable Communication Interface

Intel 8251 is also known as universal synchronous/asynchronous receiver/transmitter (USART) used to transmit serial data.

Intel 8253 : Programmable Interval Timer

The programmable counter/interval time is used in real time application of timing and counting such as BCD/binary counting, generation of time delay etc.

The 8253 uses NMOS technology and operates any of the following six modes:

1. Mode 0 ⇒ Interrupt on terminal count
2. Mode 1 ⇒ Programmable one shot
3. Mode 2 ⇒ Rate generator
4. Mode 3 ⇒ Square wave generator
5. Mode 4 ⇒ Software trigger strobe
6. Mode 5 ⇒ Hardware trigger strobe

Intel 8257 : Programmable DMA Controller

In DMA data transfer scheme, data are directly transferred from an I/O device to RAM or from RAM to an I/O device thus it is capable of performing three operations i.e. read, write and verify.

Intel 8259 : Programmable Interrupt Controller

The programmable interrupt controller is used when several I/O devices transfer data using interrupt and they are to be connected to the same interrupt level of the microprocessor.

Intel 8272 : Floppy Disk Controller

The function of floppy disk controller is to interface a floppy disk system to a microprocessor.

Intel 8275 : Programmable CRT Controller

The Intel 8275 is a single chip device. Its function is to interface CRT raster scan display with the microcomputer.

Intel 8279 : Programmable Keyboard/Display Interface

The Intel 8279 is a programmable to keyboard interfacing device. It has two sections namely keyboard section and display section. The function of keyboard section is to interface the keyboard and the function of the display section is to drive alphanumeric displays or indicator lights.



A Handbook on Electrical Engineering

13

Communication Systems

CONTENTS

1. Basics	667
2. Fourier Series, Energy and Signals	669
3. Analog Modulation	671
4. Pulse Modulation	681
5. Digital Carrier Modulation	686
6. Random Variables and Noise	689

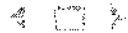

Basics

1

Communication System

A communication system is used to transfer or exchange the information between two points.

Basic Elements of Communication System

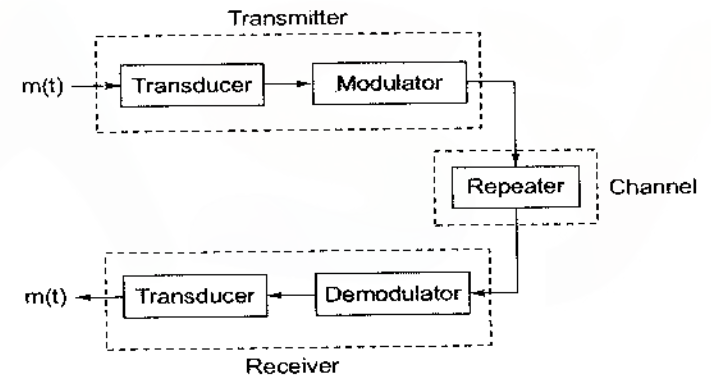

Communication system basically consists transmitter, channel and receiver.

1. **Transducer:** It is a device which converts one form of energy to another form. The input transducer convert the message signal into a time varying electrical signal.
2. **Modulator:** It is used to perform the modulation.
3. **Channel:** It is a physical medium that carries the electrical signal. It is used for connection between transmitter and receiver.
4. **Repeaters:** These produce a fresh copy of transmitted signals.
5. **Demodulator:** It performs reverse operation of modulator i.e. it converts high frequency signal to low frequency signal.

Modulation

Modulation is a process that causes a shift in the range of frequencies in a signal.

Need of Modulation

1. To decrease the length of transmitting and receiving antenna.
2. The low frequencies are attenuated fast and therefore low frequency signal can not be transmitted over a large distance. By translating the low frequency component to high frequency component, long distance communication is then possible.
3. By varying the signal power which is being transmitted, required signal to noise ratio (S/N) can then be obtained.
4. Frequency division multiplexing (FDM) is possible and therefore large number of signals can then be transmitted with different carrier frequencies over a common communication channel.

Note:

- Message signal is modulating signal and it modulates carrier signal.
- In modulation some properties of carrier signal are varied in accordance with the message signal.

Base Band Signal

The message signal generated from the information source is called base band signal. Base band signal has significant frequency component near to zero or low frequencies.

Band Pass Signal

It is a signal having significant frequencies component for range of frequencies away from zero frequency or low frequency.

Spectrum

It is frequency domain representation of a signal.

Bandwidth

It is defined as band of group of frequencies for which amplitude of signal is not zero.

Note:

- Carrier frequency is much higher than message signal frequency.
- Noise mainly added to signal in the channel.



Fourier Series, Energy and Signals

Fourier Series

Fourier Representation of Periodic Function

$$f(t) = a_0 + 2 \sum_{n=1}^{\infty} [a_n \cos n\omega_0 t + b_n \sin n\omega_0 t]$$

where

f(t) = Periodic function

$$\omega_0 = \frac{2\pi}{T_0} = \text{Fundamental frequency}$$

T₀ = Fundamental period of function f(t)

$$a_0 = \frac{1}{T_0} \int_{-T_0/2}^{T_0/2} f(t) dt \quad \dots \text{mean value of function}$$

$$a_n = \frac{1}{T_0} \int_{-T_0/2}^{T_0/2} f(t) \cdot \cos n\omega_0 t dt$$

$$b_n = \frac{1}{T_0} \int_{-T_0/2}^{T_0/2} f(t) \cdot \sin n\omega_0 t dt$$

Complex Exponential Fourier Series

$$f(t) = \sum_{n=-\infty}^{\infty} c_n \exp(-jn\omega_0 t)$$

Where,

$$c_n = \frac{1}{T_0} \int_{-T_0/2}^{T_0/2} f(t) \cdot \exp(-jn\omega_0 t) dt \quad \text{for } n = 0, \pm 1, \pm 2 \dots$$

Remember:

Fourier series is used to represent a periodic signal where as Fourier transform is used to represent a non-periodic signal.

- For distortionless transmission

$$y(t) = k g(t - t_d)$$

where $y(t)$ = Output
 $g(t)$ = Input
 k = Gain
 t_d = Time delay

- Transfer function required for distortionless transmission

$$H(\omega) = k e^{-j\omega t_d}$$

Paley-Wiener criterion

The necessary and sufficient condition for amplitude response $|H(\omega)|$ to be realizable

$$\int_{-\infty}^{\infty} \frac{\ln |H(\omega)|}{1 + \omega^2} d\omega < \infty$$

- Energy contained in a given signal $f(t)$

$$E = \int_{-\infty}^{\infty} f^2(t) dt$$

Parseval's theorems

$$E = \frac{1}{2\pi} \int_{-\infty}^{\infty} |F(\omega)|^2 d\omega$$

- Energy spectral density

$$G_E(\omega) = |F(\omega)|^2, \text{ J/Hz}$$

it is the energy contained in the signal per unit bandwidth

- Auto correlation function (ACF)

$$R(\tau) = \int_{-\infty}^{\infty} f(t) \cdot f(t - \tau) d\omega$$



3

Analog Modulation

Amplitude Modulation

Amplitude of the carrier signal (high frequency) is varied with the amplitude of modulating signal keeping frequency and the phase of the carrier fixed.

Single Tone Modulation (Sinusoidal Signal)

- Modulating Signal

$$v_m(t) = V_m \cos \omega_m t$$

where, ω_m = Modulating frequency
 V_m = Amplitude of modulating signal

- Carrier Signal

$$v_c(t) = V_c \cos \omega_c t$$

where, ω_c = Carrier frequency
 V_c = Amplitude of carrier signal

Remember:

- $\omega_c \gg \omega_m$
- $f_m = 50 \text{ Hz} - 15 \text{ kHz}$; $f_c = 535 \text{ kHz} - 1605 \text{ Hz}$
- AM broadcast range is 535 MHz - 1605 MHz.

Amplitude-Modulated (AM) Signal

$$v_{AM}(t) = [V_c + K_a V_m \cos \omega_m t] \cos \omega_c t$$

or

$$v_{AM}(t) = V_c [1 + m_a \cos \omega_m t] \cos \omega_c t$$

$$m_a = K_a \frac{V_m}{V_c}$$

where, m_a = Modulation index
 = Depth of modulation
 = Percentage modulation
 K_a = Constant of proportionality, and depends upon circuit from where AM signal has been generated

Note:

- Unless specified take $K_a = 1$ then $m_a = \frac{V_m}{V_c}$.
- Practically $0 < m_a < 1$, generally take value of $m_a = 0.45$ to 0.6 .
- If $m_a = 0$ then unmodulated signal.
If $m_a = 1$ then 100% modulated signal.

Representation of Various AM Signal**1. AM-DSB/FC**

It is a standard signal

$$v_{AM}(t) = \underbrace{V_c \cdot \cos \omega_c t}_{\text{Free carrier}} + \underbrace{\frac{1}{2} m_a V_c \cos(\omega_c + \omega_m) t}_{\text{Upper side band}} + \underbrace{\frac{1}{2} m_a V_c \cos(\omega_c - \omega_m) t}_{\text{Lower side band}}$$

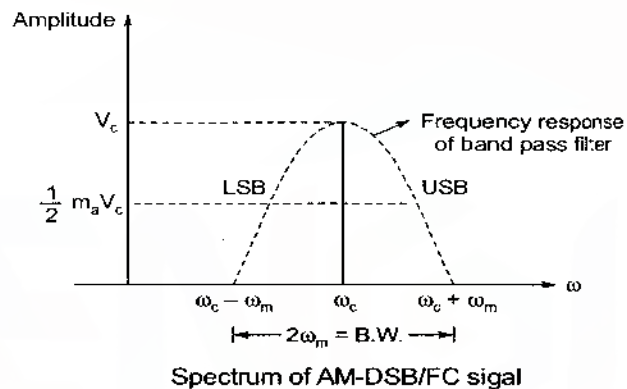
**Important Points:**

- AM-DSB/FC signal represents standard AM signal which requires maximum amount of power and maximum bandwidth for its transmission.
- Such system is used for broadcast purpose since its circuit configuration is simplest.
- Carrier carries no information. USB and LSB carry equal information since both have same frequency component with reference to the centre frequency ω_c .
- For the transmission of such signal, a band pass filter is used, having centre frequency of ω_c and a bandwidth of $2\omega_m$.
- For the transmission of such signal, a band pass filter is use, having centre frequency of ω_c and a bandwidth of $2\omega_m$.

- Total power required for transmission of AM-DSB/FC

$$P_{\text{Total}} = P_{\text{carrier}} + P_{\text{LSB}} + P_{\text{USB}}$$

$$P_t = P_c \left(1 + \frac{m_a^2}{2} \right)$$

where, P_c = Carrier power
 P_{USB} = Upper side band power
 P_{LSB} = Lower side band power

Note:

If carrier is modulated by several modulating signals then over all modulation index

$$m_a = \sqrt{m_{a1}^2 + m_{a2}^2 + \dots + m_{an}^2}$$

2. AM-DSB/SC

$$v_{AM}(t) = \frac{1}{2} m_a V_c [\cos(\omega_c + \omega_m) t + \cos(\omega_c - \omega_m) t]$$

3. AM-SSB/FC

$$v_{AM}(t) = V_c \cdot \cos \omega_c t + \frac{1}{2} m_a V_c [\cos(\omega_c \pm \omega_m) t]$$

USB
LSB

4. AM-SSB/SC

$$v_{AM}(t) = \frac{1}{2} m_a V_c [\cos(\omega_c \pm \omega_m) t]$$

Different AM System: At $K_a = 1$

System	P_t	P_s (saved power)	BW	% power saving	Complexity	SNR
AM-DSB/FC	$P_c \left(1 + \frac{m_a^2}{2} \right)$	—	$2\omega_m$	—	Min.	Max.
AM-DSB/SC	$P_c \times \frac{m_a^2}{2}$	P_c	$2\omega_m$	67%	↓	Low
AM-SSB/FC	$P_c \left(1 + \frac{m_a^2}{4} \right)$	$P_c + \frac{m_a^2}{4}$	ω_m	16%	↓	High
AM-SSB/SC	$P_c \times \frac{m_a^2}{4}$	$P_c \left(1 + \frac{m_a^2}{4} \right)$	ω_m	83%	Max.	Min.

Note:

- AM-DSB/FC system is the best from the circuit configuration point of view. It has least complexity in the circuit but requires maximum bandwidth as well as maximum power.
- AM-SSB/SC system is the worst from the circuit complexity point of view. It has maximum complexity in the circuit but power and bandwidth requirement are minimum.
- AM-DSB/FC system are used for broadcast purpose whereas AM-SSB/SC system is used for point to point communication.

- **Transmission Efficiency**

$$\eta = \frac{\text{Useful power}}{\text{Total power}}$$

$$\eta = \frac{P_s}{P_T} \times 100\%$$

Case-1: AM-DSB/FC

$$\eta = \frac{m_a^2}{2 + m_a^2} \times 100\%$$

If $m_a = 1$ then $\eta = 33\%$.

Case-2: AM-SSB/SC

$$\eta = 100\%$$

- **Percentage power savings**

$$\% \text{ Power saving} = \frac{\text{Power saved}}{\text{Total power}}$$

Case-1: AM-DSB/SC

$$\% \text{ Power saving} = (1 - \eta) = \frac{2}{2 + m_a^2}$$

Case-2: AM-SSB/SC

$$\% \text{ Power saving} = \frac{4 + m_a^2}{2(2 + m_a^2)}$$

Note:

- For full carrier system the transmission efficiency depends upon modulation index (m_a).
- For full carrier system the maximum efficiency is only 33% for maximum modulation index of unity.
- For suppressed carrier system the transmission efficiency is always independent of modulation index and is always 100%.

Multi Tone Modulation (Non Sinusoidal)**Representation of Various AM-Signal****1. AM-DSB/FC**

Standard signal
In time domain

$$v(t) = (A + f(t)) \left[\frac{1}{2} (e^{j\omega_c t} + e^{-j\omega_c t}) \right]$$

In frequency domain

$$V(\omega) = \frac{1}{2} \left[\{F(\omega - \omega_c) + F(\omega + \omega_c)\} + \pi A \{ \delta(\omega - \omega_c) + \delta(\omega + \omega_c) \} \right]$$

2. AM-SSB/SC

Standard signal
In time domain

$$v(t) = f(t) \left[\frac{1}{2} (e^{j\omega_c t} + e^{-j\omega_c t}) \right]$$

In frequency domain

$$V(\omega) = \frac{1}{2} [F(\omega - \omega_c) + F(\omega + \omega_c)]$$

Important Points:

- In suppressed carrier signal, the free carrier is absent.
- Modulation represents frequency translation. Therefore original spectrum centered about zero frequency if translated to frequency spectrum centered at ω_c .
- Using modulation any low pass signal is modulated to band pass signal.
- Negative frequencies in the original spectrum have no physical meaning.

These are represented since

- (a) The frequency spectrum of any signal is always an even function of ω and therefore negative and positive frequencies occurs in pair.
- (b) Any negative frequency can be made a positive frequency by frequency translation or using modulation.

AM Modulators and Demodulators

- Product modulation is used for generation of AM waves using non linear devices.
- Switching modulator is also used for generation of AM waves.
- Balanced modulator and ring modulators are used for generation of DSB-SC waves.
- SSB wave is generated using analog multiplier and band pass filter.
- Filter method and phase shift methods are also used for generation of SSB wave.
- Enveloped Detector

It is used for detection of AM wave.

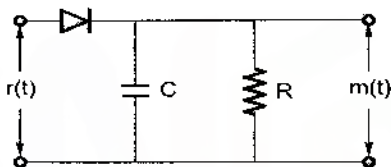

$r(t)$ is received signal and $m(t)$ is message signal and for better reception RC must be selected such as

$$\frac{1}{f_c} \ll RC \ll \frac{1}{\omega}$$

where, ω is bandwidth of message signal (in Hz).

Note:

- Demodulation of DSB-SC and SSB waves is done using coherent carrier signal at receiver.
- Envelope detector can also be used to recover message by passing received VSB signal through it.

Angle Modulation

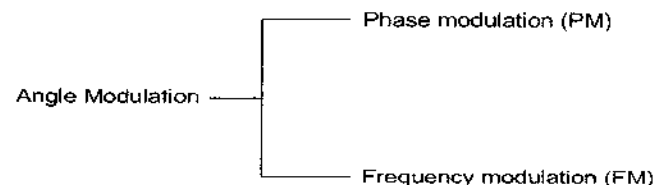

Phase Modulation (PM)

In phase modulation the phase of the carrier is varied in accordance with instantaneous value of the amplitude of the modulating signal keeping the amplitude and frequency of the carrier fixed.

General Expression

$$v_{PM}(t) = A \cos[\omega_c t + K_p f(t)]$$

where, $f(t)$ = Modulating signal

K_p = Phase sensitivity or phase deviation

Frequency Modulation (FM)

In frequency modulation the frequency of the carrier is varied in accordance with the instantaneous value of the amplitude of modulating signal keeping amplitude and phase of the carrier fixed.

General Expression

$$v_{FM}(t) = A \cos[\omega_c t + K_f \int f(t) dt]$$

where, $f(t)$ = Modulating signal

K_f = Frequency sensitivity

If $f(t) = V_m \cos \omega_m t$

then

$$v_{FM}(t) = A \cos[\omega_c t + m_f \sin \omega_m t]$$

where, $m_f = K_f \frac{V_m}{\omega_m}$ = Modulation index

Note:

- A pure PM signal or a pure FM signal cannot be obtained since the phase change or the frequency change are inter-related.
- In PM the modulation index is directly proportional to the amplitude of the modulating signal whereas the modulation index in the FM depends upon the amplitude as well as the frequency of modulating signal.

- Total Power Required for FM Signal

$$v_{FM}(t) = A \cos \left[\omega_c t + K_f \int f(t) dt \right]$$

$$P = \frac{A^2}{2}$$

- Frequency Deviation

$$\delta = m_f \omega_m \text{ rad/sec.}$$

or
$$\delta = m_f f_m \text{ Hz}$$

δ represents total bandwidth require for the transmission of FM signal.

Note:

- Bandwidth require for FM signal is always more than the bandwidth require for the AM signal.
- ω_m control the spacing between two successive sideband.
- The modulation index (m_f) controls the number of significant sidebands.

FM Standards

Remember:

- Carrier frequency = 88 MHz – 108 MHz
- Maximum frequency deviation = ± 75 kHz
- Intermediate frequency (I.F) $f_i = 10.7$ MHz

- Bandwidth

Practical bandwidth required is given by Carson's rule

$$B.W. \cong 2\omega_m (m_f + 1) \text{ rad/sec.}$$

or
$$B.W. \cong 2(\delta + \omega_m) \text{ rad/sec.}$$

Case-1: Narrow band FM (NBFM)

$$m_f \ll 1$$

$$B.W. \cong 2W_m$$

Case-2: Wide band FM (WBFM)

$$m_f \gg 1$$

$$B.W. \cong 2\delta$$

It is used in FM radio broadcast.

Note:

- Same bandwidth required for AM-DSB system.
- NBFM used in mobile radio.

Remember:

- The modulation index determines the number of sidebands. Components have significant amplitudes.
- In FM, the total transmitted power always remains constant, but with increased depth of modulation, the required bandwidth, is increased.
- Deviation ratio is the shift in carrier frequency from its resting point compared to the amplitude of the modulating voltage.
- A deviation ratio of 5 is the maximum allowed in commercially broadcast FM.

Angle Modulators and Demodulators

- FM wave can be generated using VCO caused direct method.
- FM wave can be generated using varactor diode.
- FM and PM both can be generated using reactance tubes.
- Another method is first generate narrow band FM then pass through it frequency multiplier.
- Demodulation is normally done using PLL.

Remember:

The FM system requires larger bandwidth and therefore the information is transmitted through larger number of frequency components or larger number of sidebands. Therefore the quality of recovered signal using FM system is much better as compare to that using AM system. Therefore FM system is Hi-Fi system and therefore has the ability to reproduce same quality of signal which was actually transmitted.

Superheterodyne receiver

- Sensitivity:** It is the minimum signal that should be present at input of a receiver to get standard output. It depends on gain of the receiver.

(ii) **Selectivity:** It is the ability of a receiver to reject the unwanted frequency component.

(iii) **Fidelity:** It is the ability of the receiver to reproduce all the frequency component at the output of the receiver.

• **Intermediate frequency**

$$f_i = f_l - f_s$$

where, f_l = Local oscillator frequency

f_s = desired signal frequency

• **Image frequency**

It is undesired frequency and to be rejected.

$$f_{si} = 2f_l - f_s$$

$$f_{si} = f_s + 2f_l$$

where, f_{si} = image signal frequency

• **Image Signal Rejection**

$$\alpha = \sqrt{1 + Q^2 \rho^2}$$

where, $\alpha_{dB} = 20 \log \alpha$

$$\rho = \left(\frac{f_{si} - f_s}{f_s - f_{si}} \right)$$

Q = Quality factor

Note:

- If two tuned circuit are connected in cascade then $\alpha = \alpha_1 \cdot \alpha_2$.
- The image signal rejection represents the ratio of desired signal amplitude to the amplitude of undesired signal.
- For any good radio receiver the parameter α must have high value.



Pulse Modulation

Pulse Analog Modulation

1. **Pulse amplitude modulation (PAM):** The amplitude of pulse is varied in accordance with the height of the modulating signal keeping the width and the position of the pulse constant.
2. **Pulse width modulation (PWM):** The width of the pulses is varied in accordance with the height of modulating signal keeping amplitude and position of pulse constant.
3. **Pulse position modulation (PPM):** The position or the location of the pulses is varied in accordance with the height of the modulating signal keeping the amplitude and the width of the pulses constant.

Note:

- Speed control of DC motor is done using PL/m.
- PWM is generated using 555 timer in monostable multivibrator mode.
- PPM is generated using 555 timer by using PWM as a trigger signal in monostable multivibrator mode.

Comparison of various pulse modulation signals

	Circuit Complexity	BW	SNR
PAM	Minimum	$\sim 2\omega_m$	Minimum
PWM	↓	$\sim 10\omega_m$	↓
PPM	Maximum	$\sim 1/t_r$	Maximum

where, t_r = Rise time of each pulse

Note:

- PPM is most effective pulse analog modulator scheme in forms of SNR.
- SNR should high, it is an advantage.
- The aperture effect occurs only when flat topped sampling is used. This error voltage is acceptable since the generation of flat top sampling is least complex.

Time Division Multiplexing (TDM)

1. In TDM entire time interval into smaller time slots and corresponds to each time slot, the sample from a specified signal is transmitted over a common communication channel.
2. A common sampling frequency is use for transmission of various signal.
3. Simplex circuit and less costly.
4. Used for discrete signals such as pulse modulated signals or pulse code modulated signals (PCM).

Frequency Division Multiplexing (FDM)

1. In FDM entire frequency band available is divided into smaller frequency bands and corresponding to each frequency band the signals are transmitted with different carrier frequencies at all times.
2. A separate transmitter is require for the transmission of each signal.
3. Complex circuit and therefore more costly.
4. FDM system is used for continuous signals such as AM and FM signals.

Pulse Digital Modulation

Sampling Theorem

In order to recover the original modulating signal from its sampled version the signal must be having a sampling frequency of greater than or equal to twice of highest modulating frequency component contain in the given signal i.e.

$$f_s \geq 2f_m \quad ; \quad \omega_s \geq 2\omega_m$$

where, f_s = Sampling rate

The Nyquist rate of sampling represents the minimum rate sampling so that the original signal can be recovered from its sampled version.

$$f_{s(\min)} = f_{s(\text{Nyquist})} = 2f_m \quad \text{Samples/sec}$$

where, f_m = Maximum modulating frequency component

Pulse Code Modulation (PCM)

1. The signal to noise ratio of PCM signal is very high.
2. Only two level signal and therefore the noise can always be minimise by passing the PCM signal through a limiter circuit.
3. For detecting the PCM signal a threshold level is fixed and incoming voltage is detected on the basis of whether the incoming voltage is

- more than or less than this threshold level. The detection does not depend upon the absolute value of the voltage receive but depends only upon the relative voltage receive with reference to the threshold value.
4. Very low probability of error. Error in the detection takes place only when
 - (a) The noise exceeds the threshold value.
 - (b) The signal is detected at the time instant where the nose exceeds the threshold value.

Note:

The PCM signal cannot be transmitted through antenna since the sampling is done at a rate comparable to highest modulating frequency component. Therefore the PCM signal is transmitted through a transmission line or co-axial cable and therefore the range transmission is limited.

- Quantization levels

$$L = 2^n$$

where, n = Number of bits/sample

L = Number of quantization levels

- Step size

$$\delta = \frac{2V_m}{L} = \frac{2V_m}{2^n}$$

where, V_m = Maximum amplitude of sinusoidal signal

- Quantization Noise

$$N_q = \frac{\delta^2}{12}$$

- Signal to Noise Ratio (SNR)

$$\frac{S_0}{N_q} = \frac{3}{2} L^2 = \frac{3}{2} 2^{2n} \quad ; \quad \left(\frac{S_0}{N_q} \right)_{\text{dB}} \approx 1.76 + 6n$$

- Bit rate

$$R_b = n f_s$$

where

f_s = Number of samples per sec.

- Min-bandwidth

$$BW_{\min} = \frac{1}{2} R_{b(\min)} = n f_m$$

Note:

The bit coding parameter 'n' is adjusted depending upon.

- Availability of B.W. of transmission.
- Required value of the signal to noise ratio.
- The complexity of circuit which we can afford for the transmission of given signal.

Delta Modulation

As the bit coding parameter increases the number of quantization level of the quantizer will increase. Therefore design of the quantizer becomes more complex.

The use of quantizer is avoided in the delta modulation system. It has much simpler circuit and SNR of the delta modulation system is comparable to the PCM system since both are digital modulation system.

Error Signal

$$\Delta(t) = f(t) - \hat{f}(t)$$

where, $f(t)$ = Present sample value of the input signal

$\hat{f}(t)$ = Latest approximation to $f(t)$

Remember:

$$f_s|_{DM\ system} > f_s|_{PCM\ system}$$

f_s = Sampling Frequency

$$BW|_{DM\ system} > BW|_{PCM\ system}$$

Noise in DM system

1. Granular noise
2. Slope overload noise

(a) To minimize granular noise:

- (i) Step size 'δ' should be decreased to limit the range of transmission.
- (ii) Sampling frequency increased, $f_s \sim 3$ to 4 times of f_m .

(b) To avoid slope overload noise

$$\delta \cdot f_s \geq 2\pi f_m A \quad ; \quad A_{\max} = \frac{\delta f_s}{2\pi f_m}$$

To avoid or minimize slope overload noise, the above mention condition must be satisfied and it is controlled by solving 4 parameters.

- (i) Maximum amplitude of the modulating signal.
- (ii) Frequency of the modulating signal.
- (iii) Step size 'δ'.
- (iv) The sampling frequency f_s .

Note:

If these conditions are specified, still the slope overload noise will always occur. To minimise the slope overload noise under this condition a delta modulator with variable step size is used. Such delta modulator is then called, adaptive delta modulator (ADM).

Adaptive Delta Modulation (ADM)

- In adaptive delta modulation, step size is chosen in accordance with message signal sampled value to overcome slope overload error and hunting.
- If message is varying at a high rate then step size is high and if message is varying slowly the step size is small.

Note:

- In case of ADM and DM bandwidth required is almost same.
- The PCM and DM signal cannot be transmitted through antenna, since the sampling is done at the rate f_s or Δf_s , therefore such signals are then transmitted through a transmission line so that the range of transmission is limited.
- To transmit such signals through antenna, a high frequency carrier is modulated using the PCM or DM signals as the modulating signals, therefore a low pass signal is converted to a band pass signal and is then transmitted through antenna for long distance communication.



Digital Carrier Modulation

- In digital carrier modulation system, the modulating signal is digital which is the output of PCM or DM system and carrier signal is high frequency sinusoidal carrier.
- In digital carrier modulation system one of the properties of the carrier, namely amplitude, frequency or the phase is varied at a time with the binary modulating signal.
 - Amplitude shift keying:** The generation of ASK signal is simplest, is amplitude dependent, maximum noise is introduced and therefore ASK system has lowest signal to noise ratio.
 - ASK signal uses ON-OFF signaling.
 - In ASK probability of error (P_e) is high.
 - The ASK system is used for telegraphy.
 - Frequency shift keying:** The circuit configuration of FSK system is most complex, requires large bandwidth for its transmission but has relatively high S/N ratio.
 - FSK signal uses NRZ signaling.
 - In case of FSK, P_e is less.
 - Multiplexing is difficult.
 - Used in MODEM.
 - Phase shift keying:** The PSK system has relatively high SNR, relatively complex circuit, require lesser bandwidth as compare to FSK system.
 - PSK signal uses NRZ signaling.
 - This system has lowest probability of error
 - The PSK in its modified form is used for satellite communication or for the mobile communication.
- Comparison between ASK, PSK, FSK**

Parameter	ASK	PSK	FSK
E	$\frac{1}{2} A^2 T$	$\frac{1}{2} A^2 T$	$E' = 2E$
P_s	$\frac{1}{2} \left(\frac{E}{T} \right)$	$\left(\frac{E}{T} \right)$	$\left(\frac{E}{T} \right)$
$P_{e(\min)}$	$\text{erfc} \sqrt{\frac{P_s T}{\eta}}$	$\text{erfc} \sqrt{\frac{2P_s T}{\eta}}$	$\text{erfc} \sqrt{\frac{P_s T}{\eta}}$
BW	$\frac{2}{T_b}$	$\frac{2}{T_b}$	$(f_2 - f_1) + \frac{2}{T_b}$

Binary Phase Shift Keying (BPSK)

- Waveform $b(t)$ is a NRZ (non-return-to-zero) binary waveform
- Transmitted Signal

$$V_{\text{BPSK}}(t) = b(t) \sqrt{2P_s} \cos \omega_0 t$$

where, P_s = Signal power
 $b(t) = 1$ V for Logic level 1
 $= -1$ V for Logic level 0

- Received signal

$$V_{\text{BPSK}}(t) = b(t) \sqrt{2P_s} \cos(\omega_0 t + \theta)$$

where, θ = Phase shift corresponding to time delay θ/ω_0
 Phase shift depends on the length of the path from transmitter to receiver

- Power spectral density of the BPSK signal

$$G_{\text{BPSK}}(f) = \frac{P_s T_b}{2} \left\{ \left[\frac{\sin \pi(f - f_0) T_b}{\pi(f - f_0) T_b} \right]^2 + \left[\frac{\sin \pi(f + f_0) T_b}{\pi(f + f_0) T_b} \right]^2 \right\}$$

where, T_b = Bit duration

- Energy contained in a bit duration

$$E_b = P_s T_b$$

- Bandwidth

$$BW = \frac{2}{n T_b}$$

where, n = Number of input

Remember:

- Differential phase-shift keying (DPSK) and differential encoded PSK (DQPSK) are modifications of BPSK.
- DPSK avoids the need to provide the synchronous carrier required at the demodulator for detecting a BPSK signal.

Quadrature Phase Shift Keying (QPSK)

- Four quadrature signals

$$V_m(t) = \sqrt{2P_s} \cos \left[\omega_0 t + (2m + 1) \frac{\pi}{4} \right] \dots m = 0, 1, 2, 3$$

- Bandwidth

$$BW = \frac{2}{2T_b} = R_b$$

M-ARY PSK

$$V_m(t) = \sqrt{2P_s} \cos(\omega_0 t + \phi_m) \quad \dots m = 0, 1, 2, \dots (M-1)$$

- Phase Angle

$$\phi_m = (2m+1) \frac{\pi}{M}$$

Binary Frequency Shift Keying

$$V_{\text{BFSK}}(t) = \sqrt{2P_s} \cos[\omega_0 t + d(t)\Omega t]$$

where, $d(t) = 1$ for logic levels 1 of data waveform
 $= -1$ for logic levels 0 of data waveform
 $\Omega =$ Constant offset from nominal carrier frequency

Note:

$$BW_{\text{(BFSK)}} = 2 \times BW_{\text{(BPSK)}}$$

Minimum Shift Keying

- Transmitted signal

$$V_{\text{MSK}}(t) = \sqrt{2P_s} \left[\left\{ b_e(t) \sin 2\pi \left(\frac{1}{4T_b} \right) \right\} \cos \omega_0 t + \left\{ b_o(t) \cos 2\pi \left(\frac{1}{4T_b} \right) \right\} \sin \omega_0 t \right]$$

- Most important and useful feature of MSK is its phase continuity

$$\int_0^{T_b} \sin \omega_H t \cdot \sin \omega_L t dt = 0$$

- Probability of error in the detection of any signal.

$$P_{e(\text{min})} = \text{erfc} \left(\frac{a}{\sqrt{\eta E/2}} \right)$$

where, $\text{erfc}(u) =$ Complementary error function
 $a =$ Threshold level



Random Variables and Noise

Theory of Random Signals and Process

1. If $p(x)$ is the probability density function

$$\int_{-\infty}^{\infty} p(x) dx = 1$$

2. Cumulative distribution function (CDF)

$$P(X) = \begin{cases} \int_{-\infty}^x p(x) dx, & X \leq x \\ 1, & X < \infty \end{cases}$$

3. Avg. or dc value of signal/mean

$$\bar{X} = E(X) \equiv m = \int_{-\infty}^{\infty} x p(x) dx$$

4. DC power contained in the given signal

$$P_{\text{cc}} = m^2$$

5. Total power contained in the given signal/mean square value

$$\bar{X}^2 = E(X^2) \equiv \int_{-\infty}^{\infty} x^2 p(x) dx$$

6. AC power contained in the signal/variance

$$P_{\text{AC}} = \sigma_x^2 = [E(X^2) - m^2]$$

where, $\sigma_x =$ Standard deviation

7. RMS voltage

$$V_{\text{rms}} = \sqrt{\bar{X}^2} = \sqrt{E(X^2)}$$

Noise

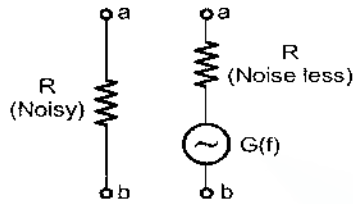

- Power spectral density of thermal noise

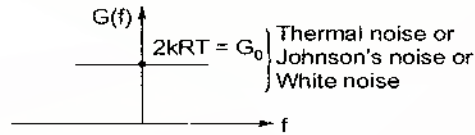

$$G(f) = 2kRT$$

where $k =$ Boltzmann constant
 $= 1.38 \times 10^{-23} \text{ J/}^\circ\text{K}$

- Noise power

$$N_0 = \int_{-\infty}^{\infty} G(f)df = \int_{-\infty}^{\infty} 2kRTdf = \infty$$

- The thermal noise requires infinite amount of power for its generation and infinite amount of BW for its transmission.
- Band limited thermal noise.

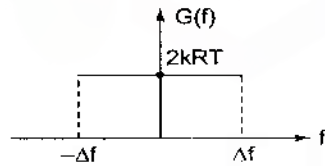

$$G(f) = 2kRT \text{ W/Hz} \dots -\Delta f < f < \Delta f$$

$$N_0 = \int_{-\Delta f}^{+\Delta f} G(f)df = 4kRT\Delta f \text{ W}$$

$$V_{rms} = \sqrt{N_0} = \sqrt{4kRT\Delta f} \text{ V}$$

Noise Figure of a Communication System

- The noise figure of any communication system is a measure of total noise power contributed by that communication system.
- For an ideal communication system or for a noise-less system the noise figure has a minimum value of unit.

$$F = \frac{\text{Input SNR}}{\text{Output SNR}}$$

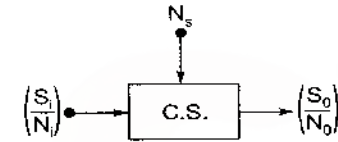

$$F = 1 + \frac{N_s}{AN_i} = 1 + \frac{T_{eq}}{T_0} = 1 + \frac{R_{eq}}{R_s}$$

where, $A =$ Power gain
 $N_s =$ System noise power
 $N_i =$ Input noise power
 $T_{eq} =$ Equivalent noise temperature
 $T_0 =$ Room temperature
 $R_{eq} =$ Equivalent input noise resistance
 $R_s =$ Source resistance

- Noise figure of cascaded Communication Systems

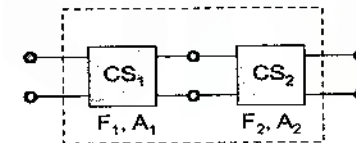

$$F = F_1 + \frac{F_2 - 1}{A_1} + \frac{F_3 - 1}{A_1 A_2} + \dots$$

Note:

- Higher the value of noise figure, higher is the contribution of the noise by that system.
- The noise figure of any system does not depend upon signal power at the input. Therefore the noise figure remain same irrespective of the variation in the input signal power.

EASY ENGINEERING

© Apprise Education, Reprise Innovations ©